

Dissolved Organic Carbon in the ocean

The profile of [DOC] with depth

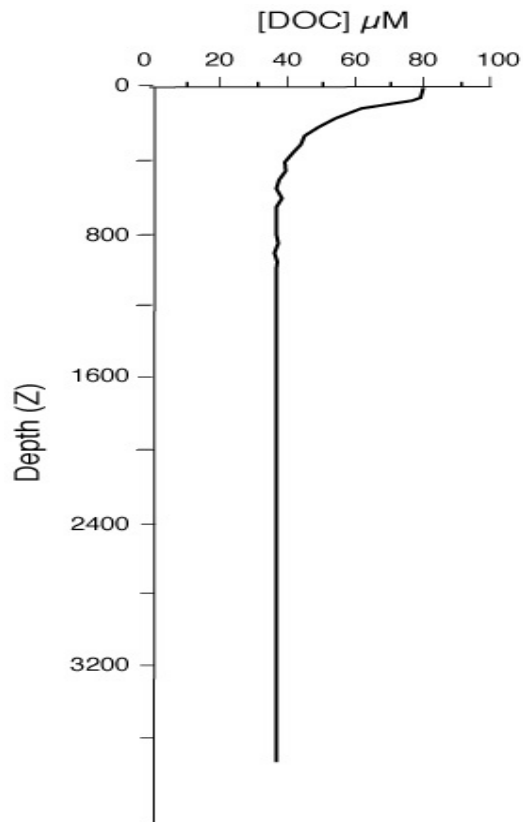

1. Measured by HTCO or wet chemical oxidation
2. Surface values are 60-80 μM C
deep sea values are 40 μM C
3. Deep sea values are nearly constant (implies some tight feedback/control)
4. Global inventory is 680 GT C. Most Resides in the deep ocean!

Radiocarbon in the Atlantic and Pacific Oceans

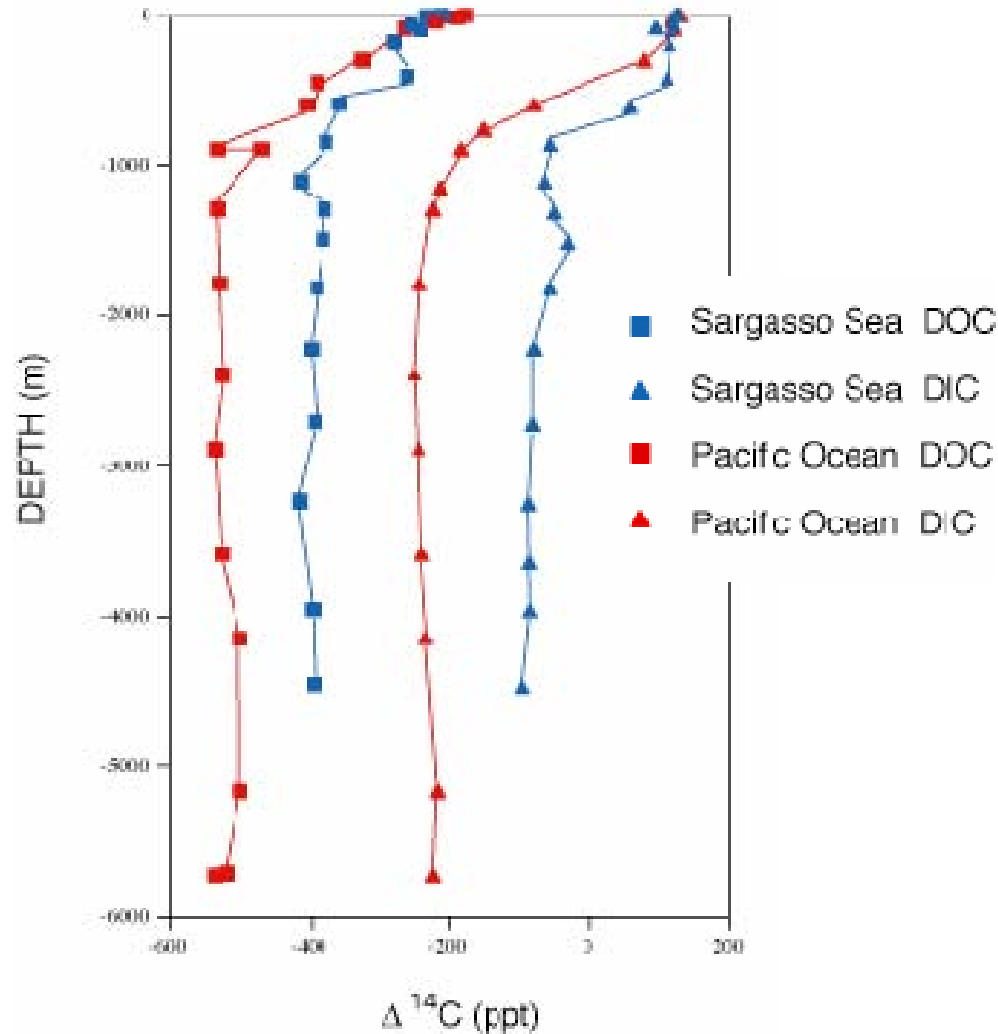

DIC ^{14}C has the same Value in the Atl and Pac

$\Delta\Delta^{14}\text{C}$ of DIC and DOC is about the same in the deep Atl and Pac oceans

Deep ocean values are equal to a RC age of Several 1000's years

Either there is a source of "old" DOC, or DOC lasts for several ocean mixing cycles

^{13}C Nuclear Magnetic Resonance Spectrum of high molecular weight dissolved organic matter

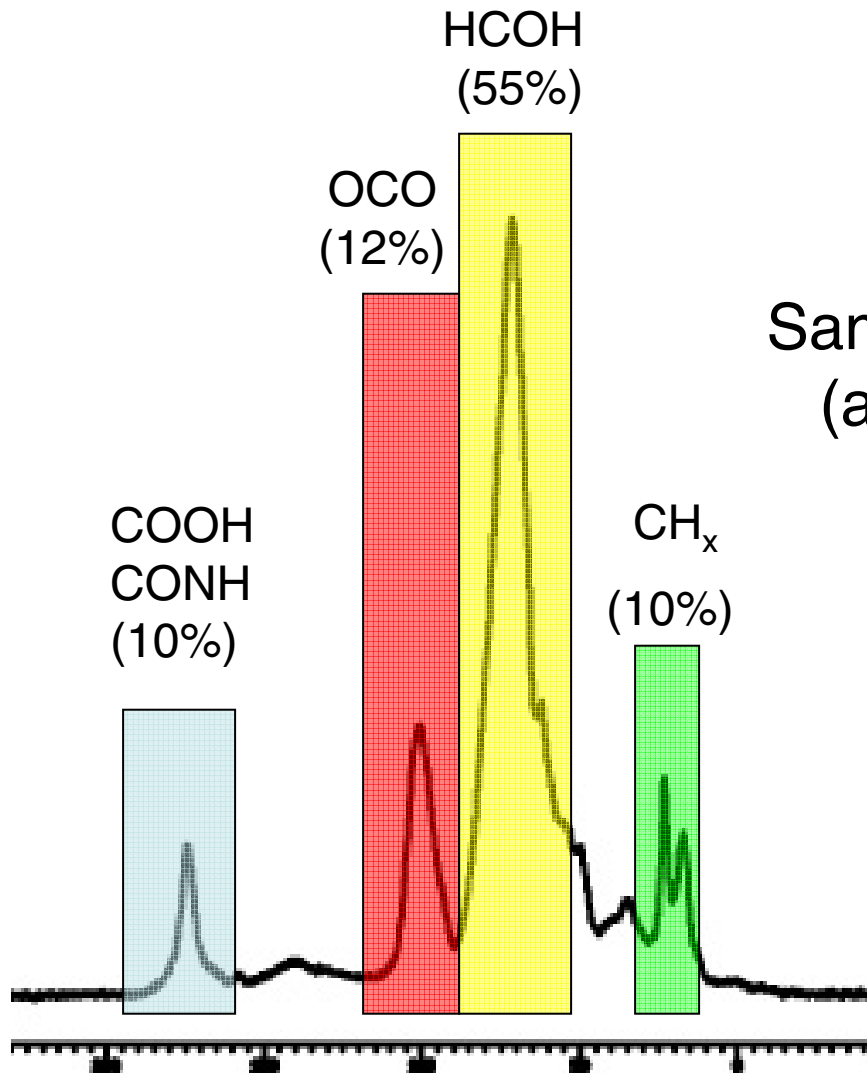

C/N = 15 ± 3

Same spectrum everywhere
(at a comparable depth)

carbohydrates >
proteins >
lipids >
nucleic acids(P)

^1H NMR of high molecular weight DOC

But....

Carbohydrates by NMR
are 50-70% of the total

by molecular level techniques
they are only 15% or less..

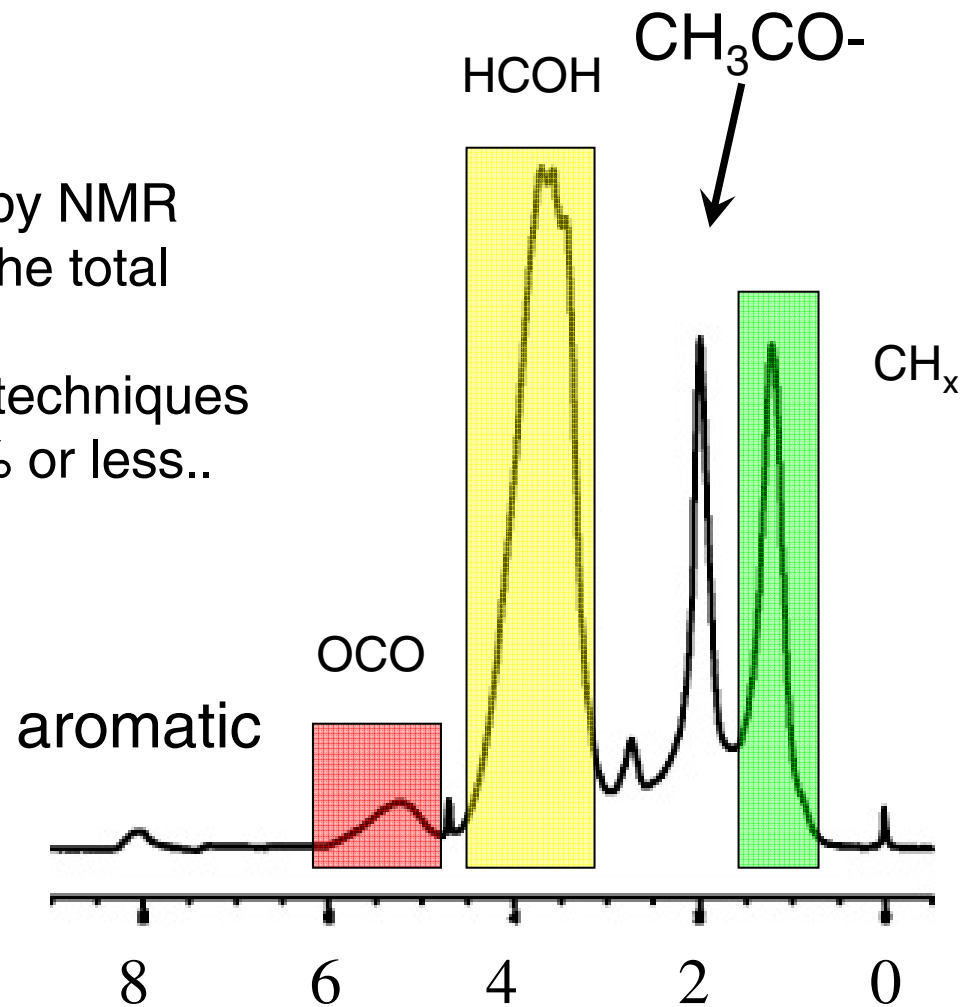

^{15}N -NMR of HMWDOC. Is HMWDON from proteins or from amino sugars?

Amide (RCON)
(90-100%)

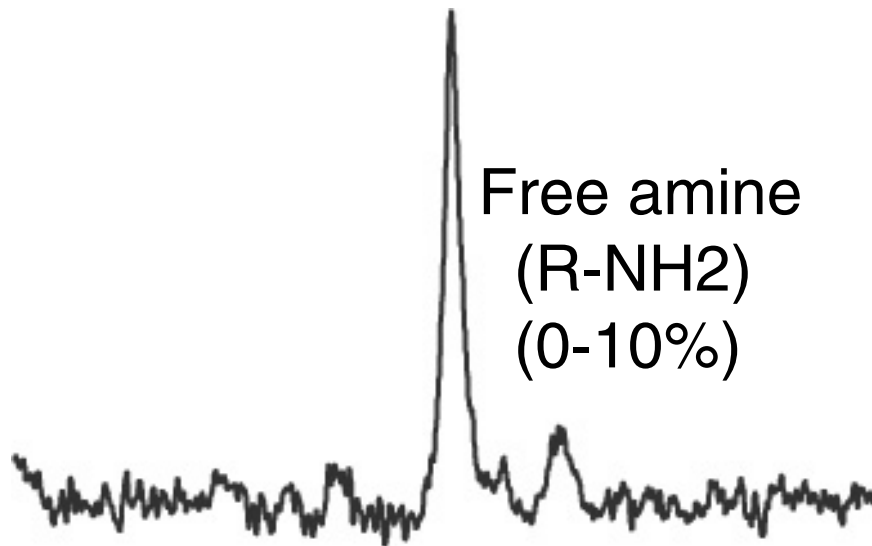

amino sugars

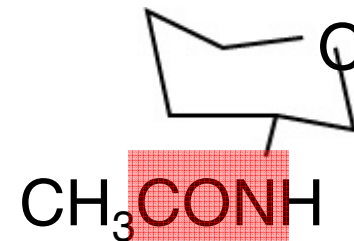

proteins

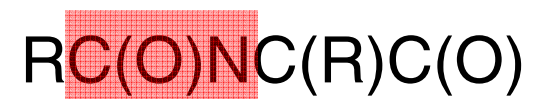

Is a large fraction of HMWDOC and HMWDON
from amino sugars or proteins?

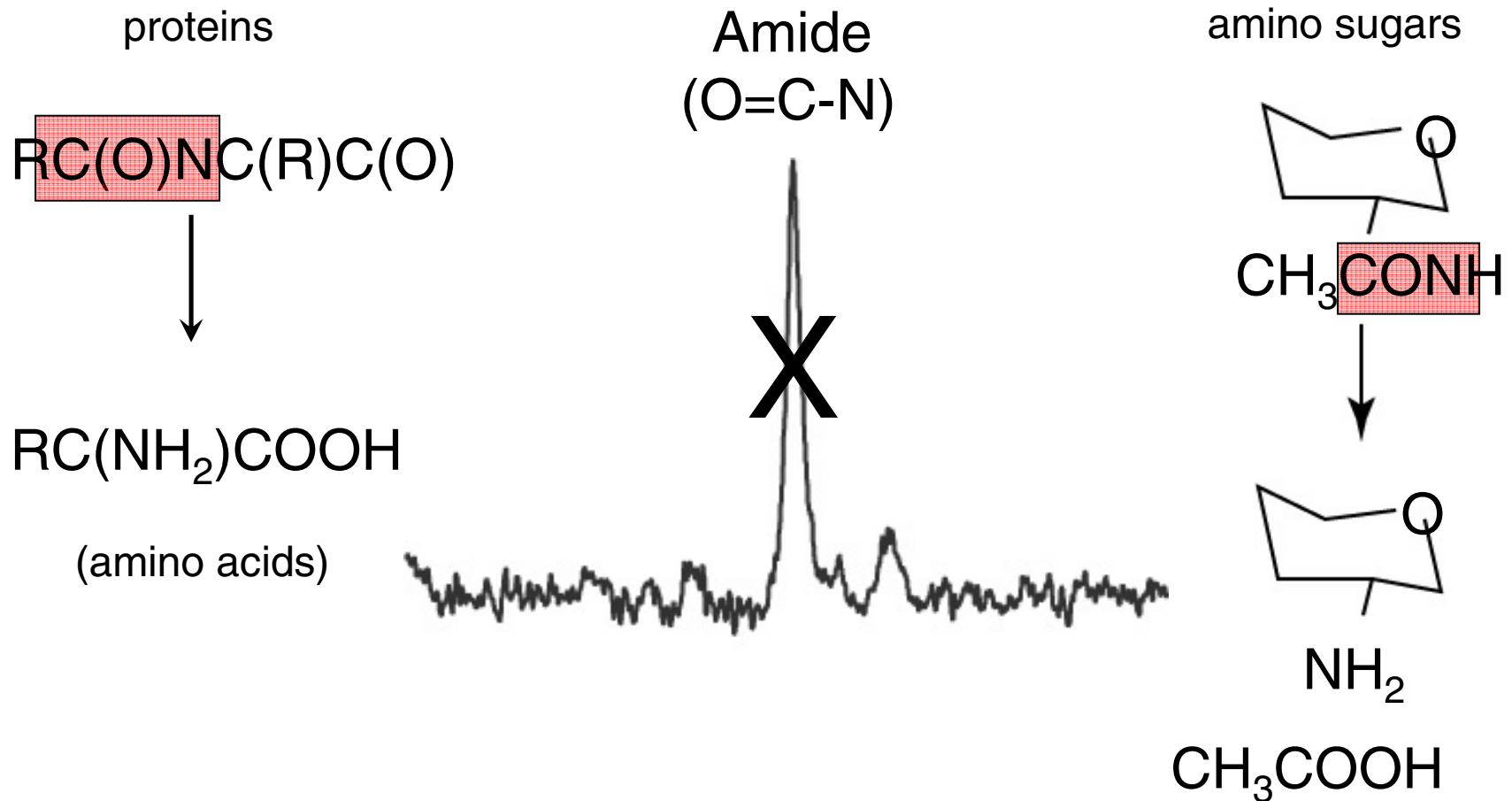

Is a large fraction of HMWDOC and HMWDON from amino sugars?

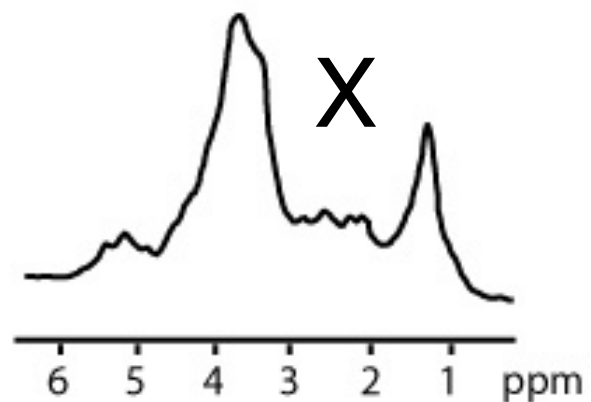
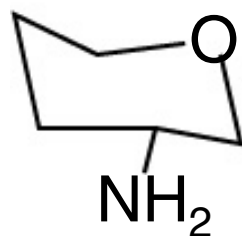
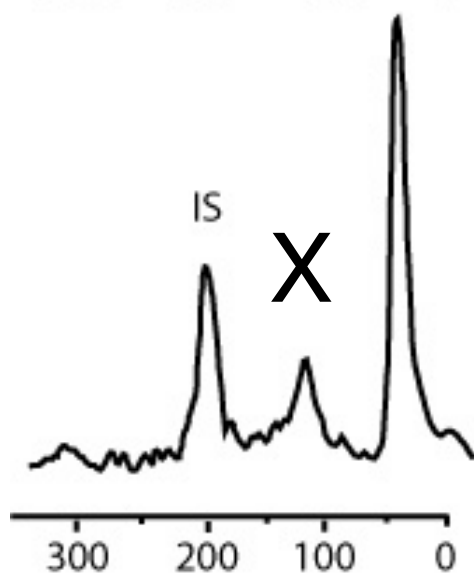
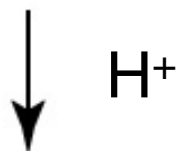
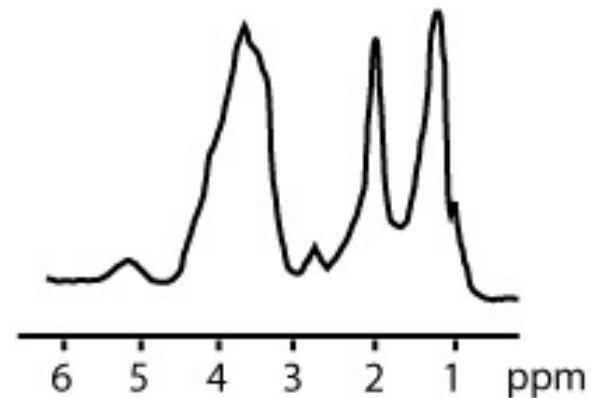
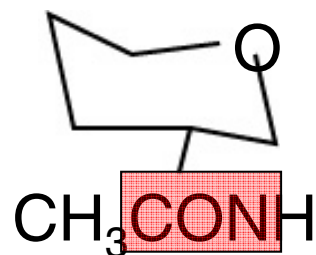
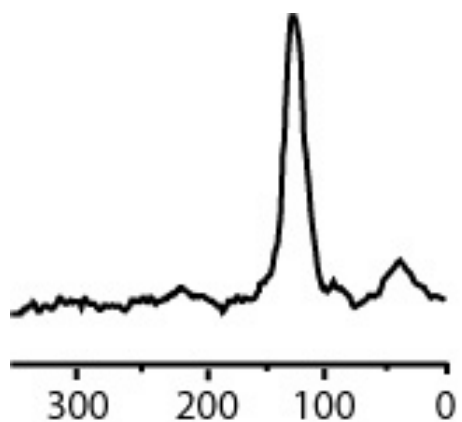

The composition of HMWDON

Sample	ΣN	$\Sigma \text{amide(NMR)}$	Δamide	AcOH	AA	$\Sigma \text{AcOH+AA}$	ΣRN
WH	7.7	7.1	-4.4	3.3	1.0	4.3	2.7
MAB _(1000m)	7.7	7.7	-1.8	1.3	0.8	2.1	5.8
Hawaii _(23m)	6.2	6.2	-3.7	-3.3	0.5	3.8	2.4
Hawaii ₍₆₀₀₎	6.2	6.2	-3.7	-3.4	0.4	3.8	2.4

The amount of amide lost via hydrolysis equals the amount of acetic and amino acid released into solution. A large fraction of HMWDON in surface water (up to 50%) is amino sugars. In the deep ocean most HMWDON is uncharacterized.

Dissolved Proteins in seawater

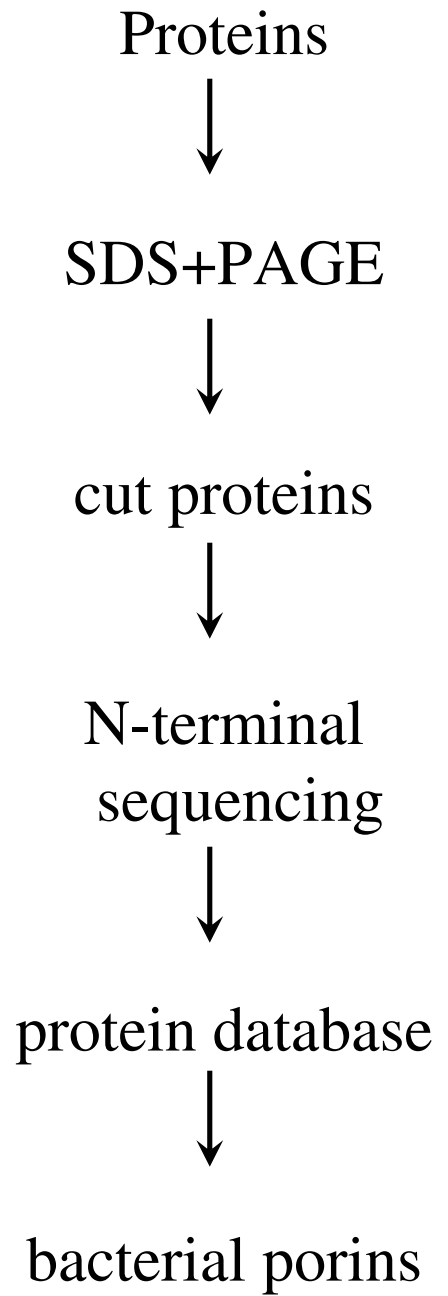
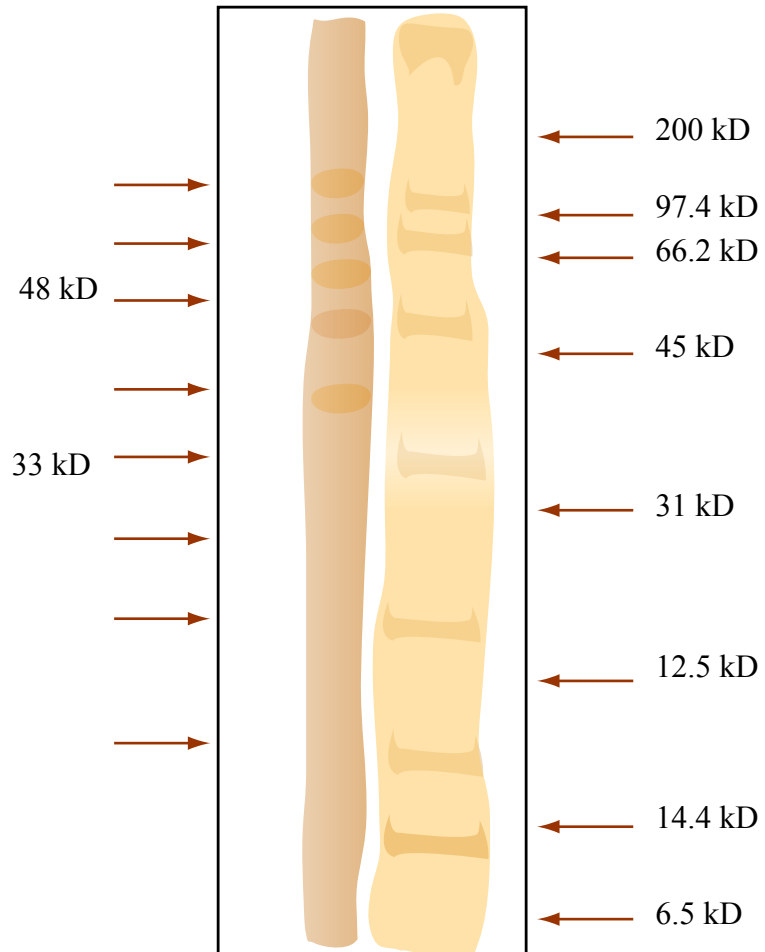
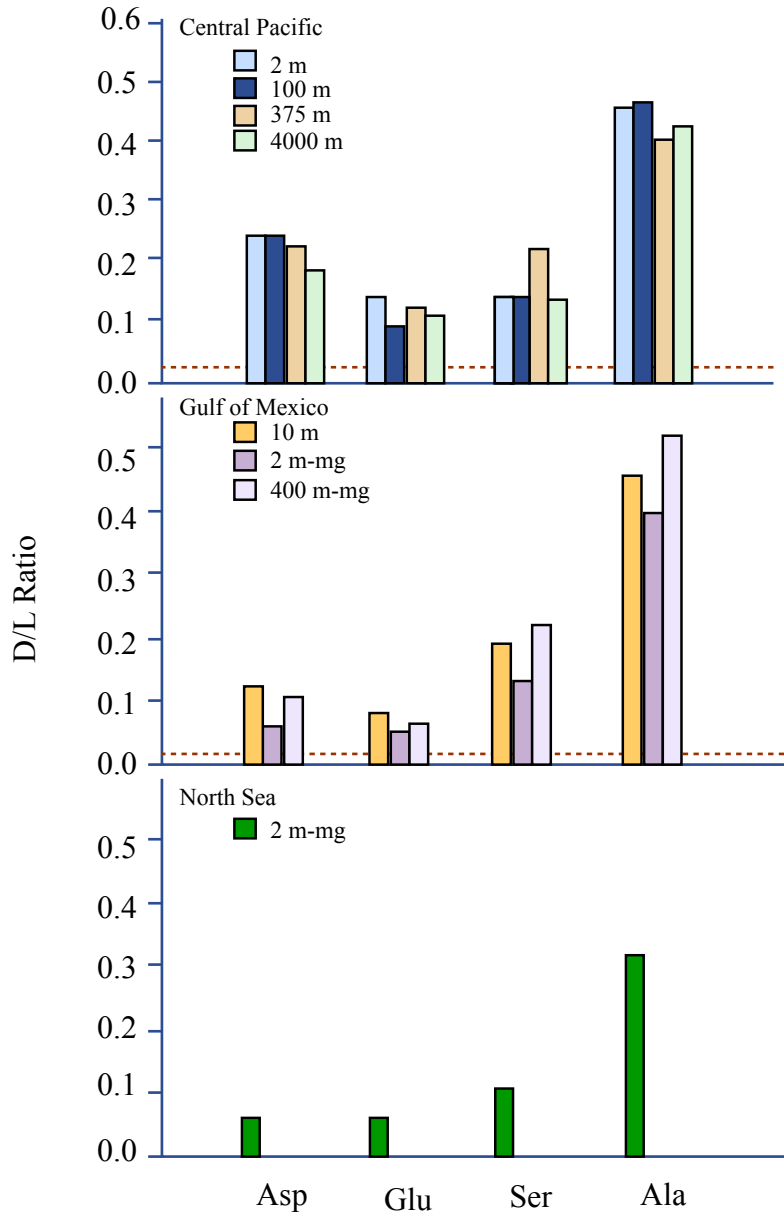
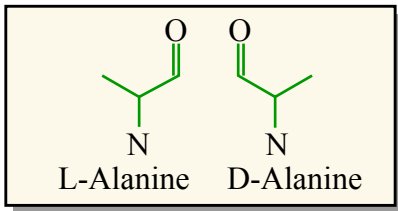
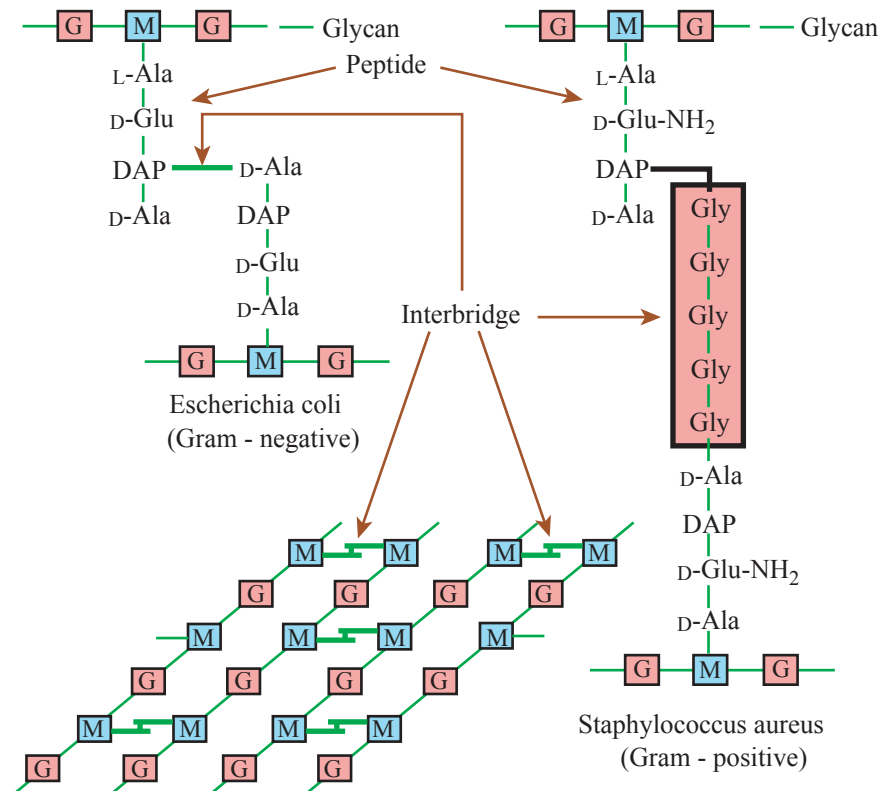

Figure by MIT OCW.



Peptidoglycan in DOC

Amino acid analyses of HMWDOC shows AA distribution is pretty much the same everywhere. AA make up only 3-5% of DOC, but are 14-30% of HMWDON. The distribution of AA does not reveal much about sources, but the high D/L ratio has been used to argue that there is a significant bacterial source for HMWDON, and more specifically that peptidoglycans from eubacterial cell walls are a part of HMWDON



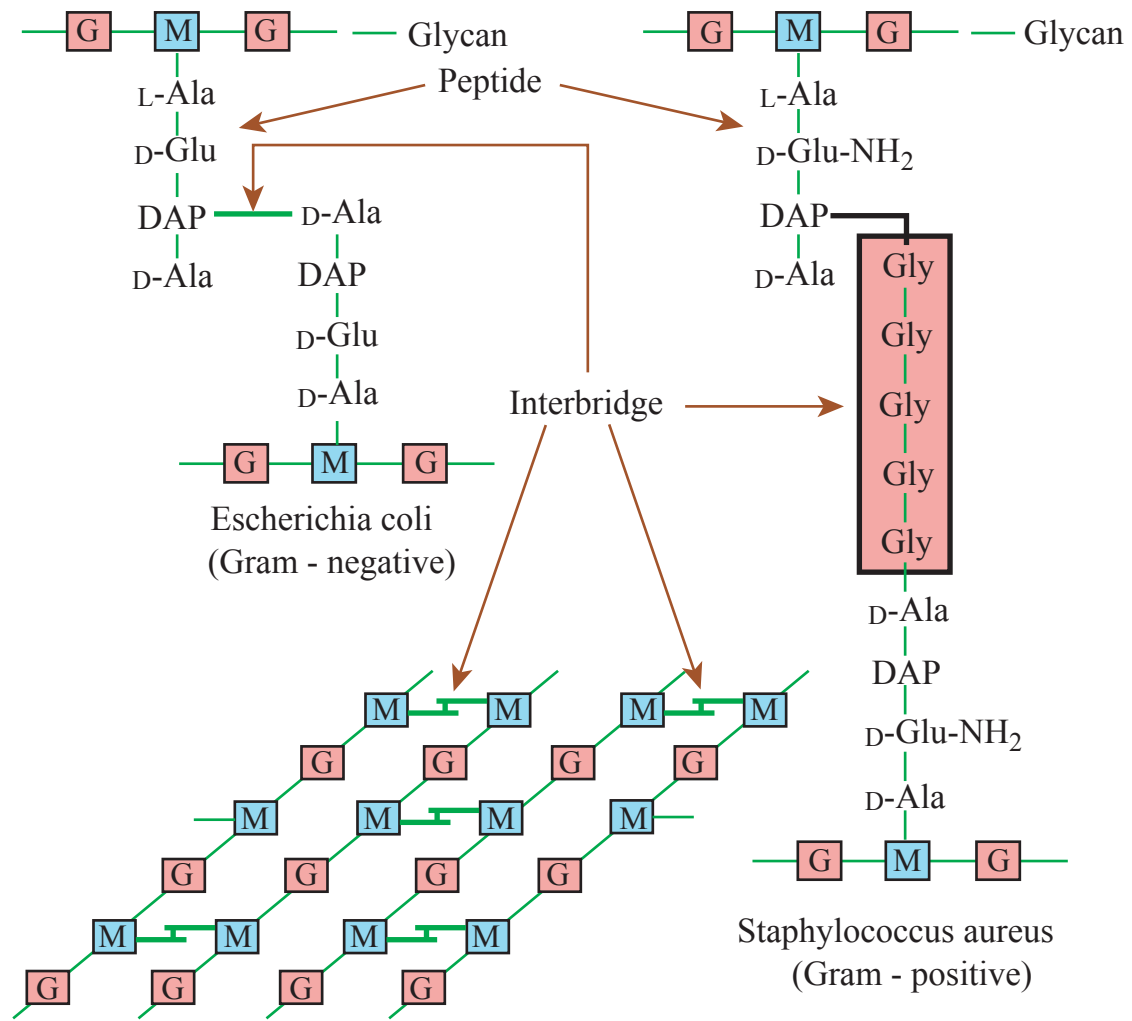

Schematic representation of the structure of bacterial peptidoglycan (after Brock et al., 1994). The upper two images illustrate the linkages of structural units within peptidoglycans of species of Gram-negative and Gram-positive bacteria. The network to the lower left shows how these units are assembled into a peptidoglycan sheet (peptide crosslinks in bold) that is relatively resistant to biodegradation. A breviations: G = N-acetylglucosamine, M = N-acetylmuramic acid, DAP = meso-diaminopimelic acid, Ala = alanine, Gly = glycine, Glu = glutamic acid.

The composition of 'lipid' in HMWDOC

NMR detects functional groups, not biochemicals
 CH_x can come from more than one biochemical

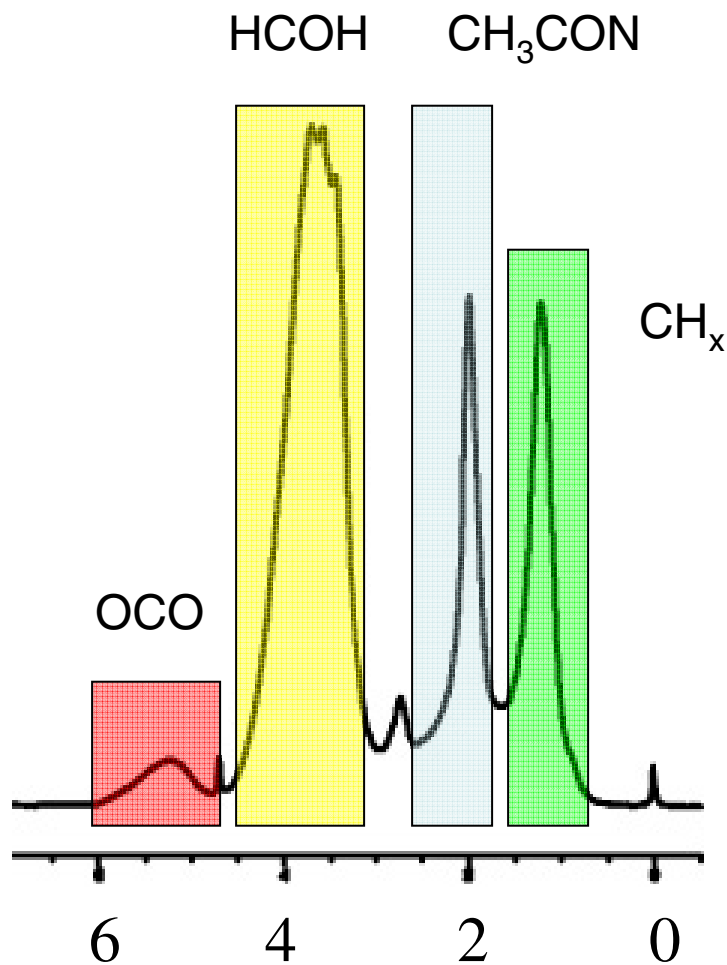

Lipid

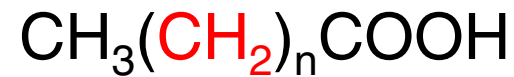

Deoxy sugars

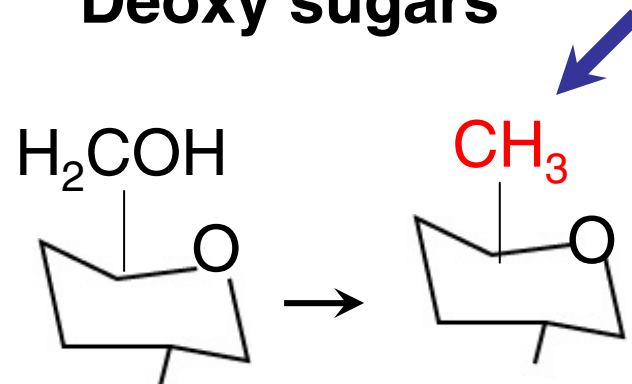

The hydrolysis of HMWDOC yields only small amounts (1%) of classical lipids!

Fatty Alcohols

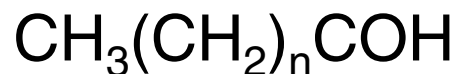
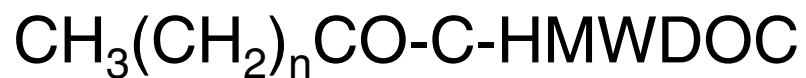

Fatty Acids

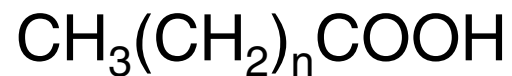

We can use chemical techniques such as periodate oxidation, which selectively oxidizes sugars to test if lipids are really present in HMWDOC

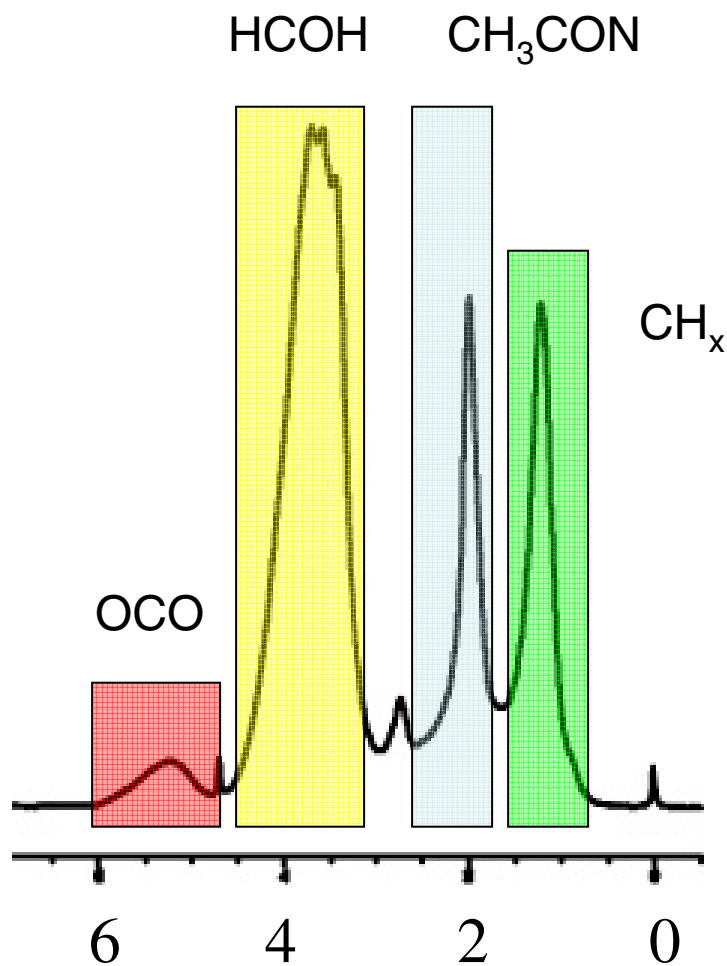

Lipid

periodate

RCOH → No Reaction

Deoxy sugars

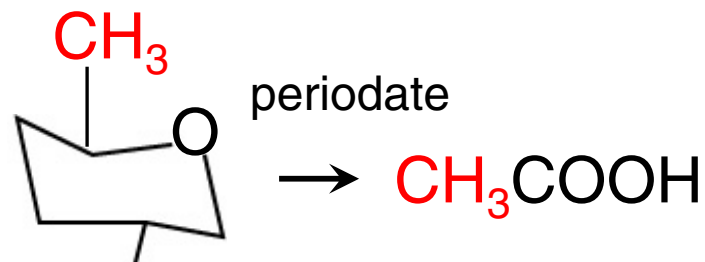

Periodate oxidation of HMWDC⁻

Acetic Acid

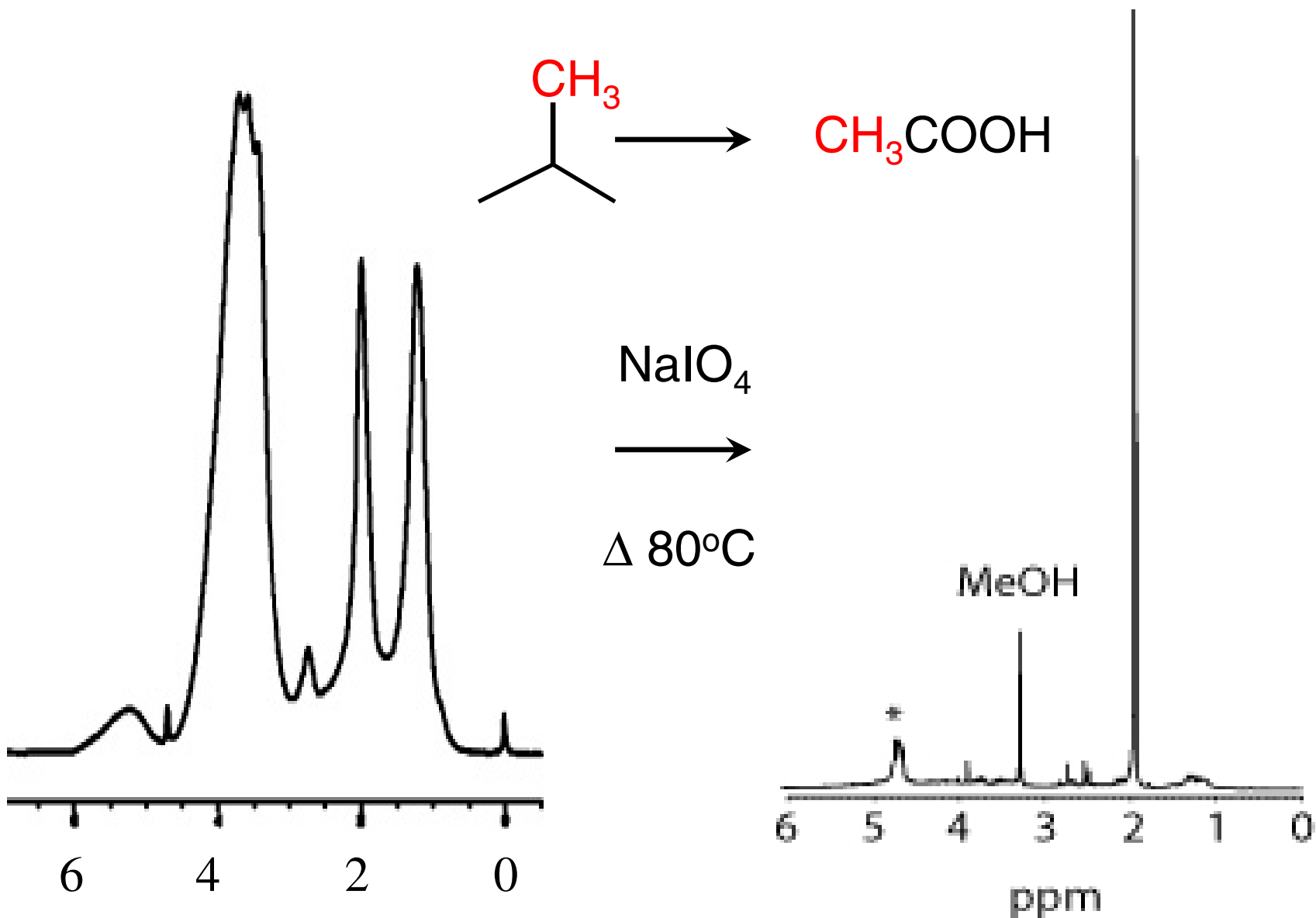

HMWDOC composition summary

Direct chemical analyses show that HMWDOC is 50-70% carbohydrate, 5-6% acetamide, and 5-6% "lipid"

Chemical hydrolyses techniques find HMWDOC to be 15% carbohydrate, 3-5% protein, and <1% lipid

Indirect chemical analyses show that an additional 25% is amino sugars, and 25% is deoxysugars. However, *There is no direct confirmation of this.*

For reasons no one understands, HMWDOC is not amenable to classical chemical analyses. A good portion (>25%) remains uncharacterized. Much more (>85%) at the molecular level.

Terrestrial DOC in the ocean

A small fraction of the DOC added to the ocean by rivers is colored (colored dissolved organic matter or CDOM) that can be tracked by remote sensing. This DOC interferes with satellite determinations of ocean productivity, especially near the coast.

Images removed due to copyright restrictions.

DOC transport through estuaries and the input of terrestrial organic carbon to the ocean.

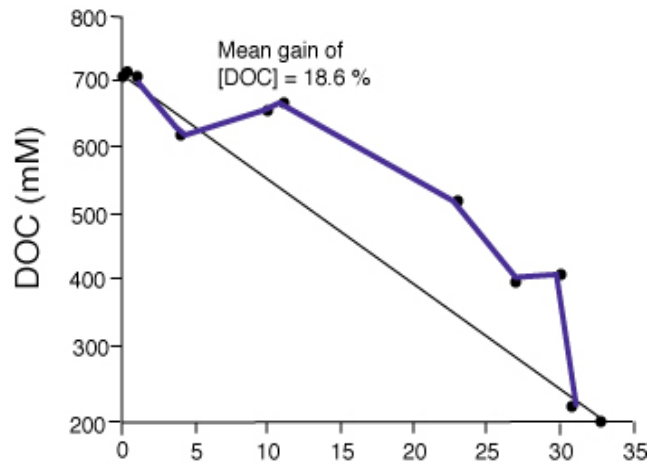

DOC concentrations are nearly always higher in rivers than in the ocean. Rivers add C to the ocean.

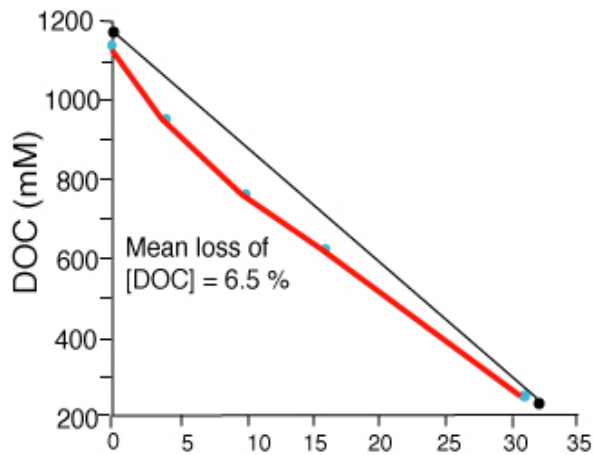

In general, DOC displays conservative behavior wrt salinity in estuaries.

Some estuaries add carbon, some remove it.

Endeavor 9603 Surface DOC Contour

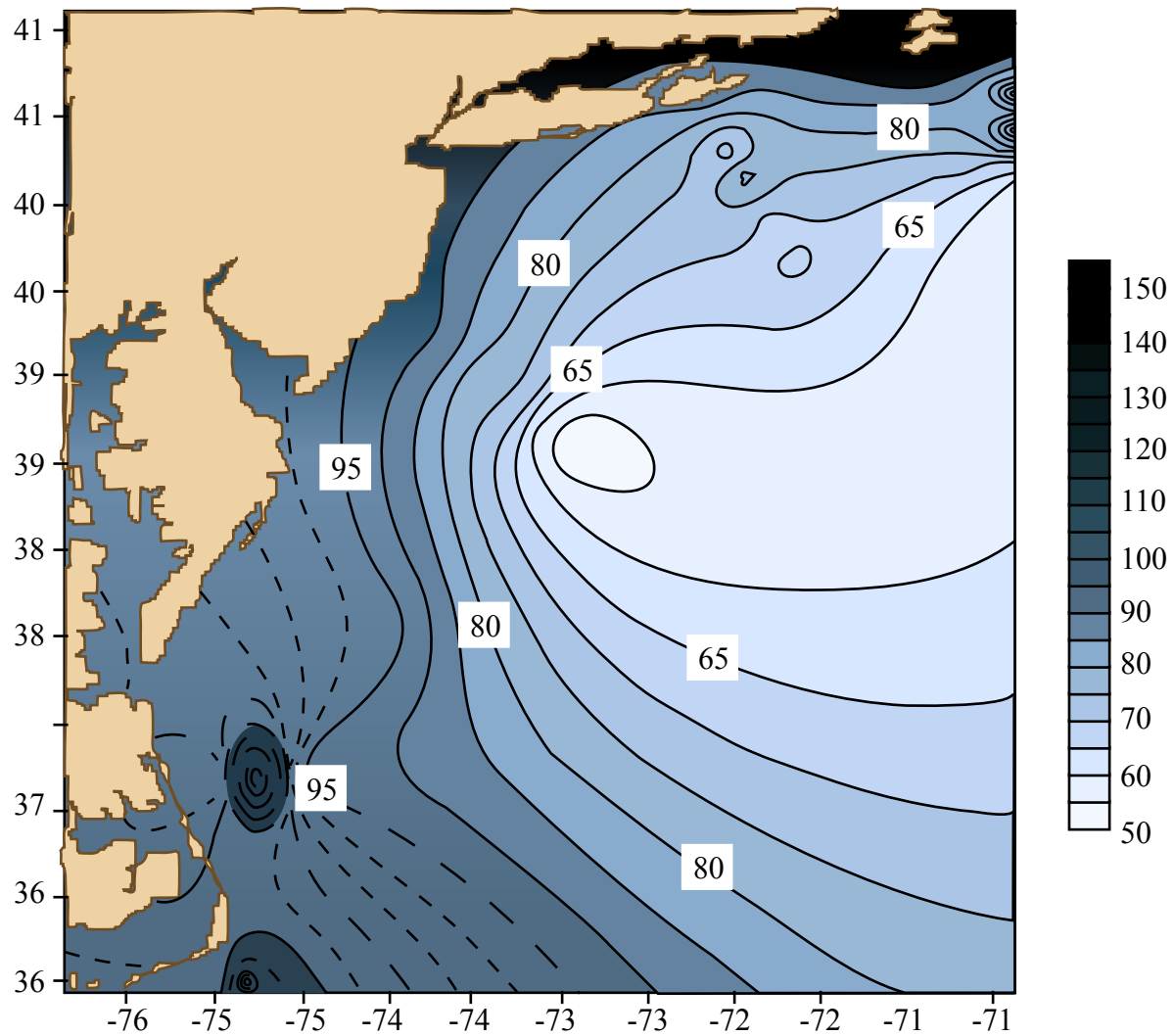

Figure by MIT OCW.

Potential contribution of rivers to marine DOC

DOC concentrations in rivers

River	[DOC] (μM)
North Dawes (Alaska)	42
Alpine streams	125-400
Amazon	150-500
Columbia	250
Mississippi	300-600
Missouri	150-700
Yukon	1300
Williamson	2500
Sopchoppy (FLA)	4200

Global River DOC Inputs

DOC Flux (GT C/ yr)

0.15	(Duce and Duursma, 1977)
0.18	(Williams, 1975; Mopper and Degans, 1979)
0.22	(Maybeck, 1981)
0.30	(Handa, 1977)
0.36	(Alekin, 1978)
0.76	(Mantoura and Woodward, 1983)
1.0	(Richey, 1981)

Extraction of marine “humic substances” from lakes, rivers, and seawater

Seawater
(pH = 2)

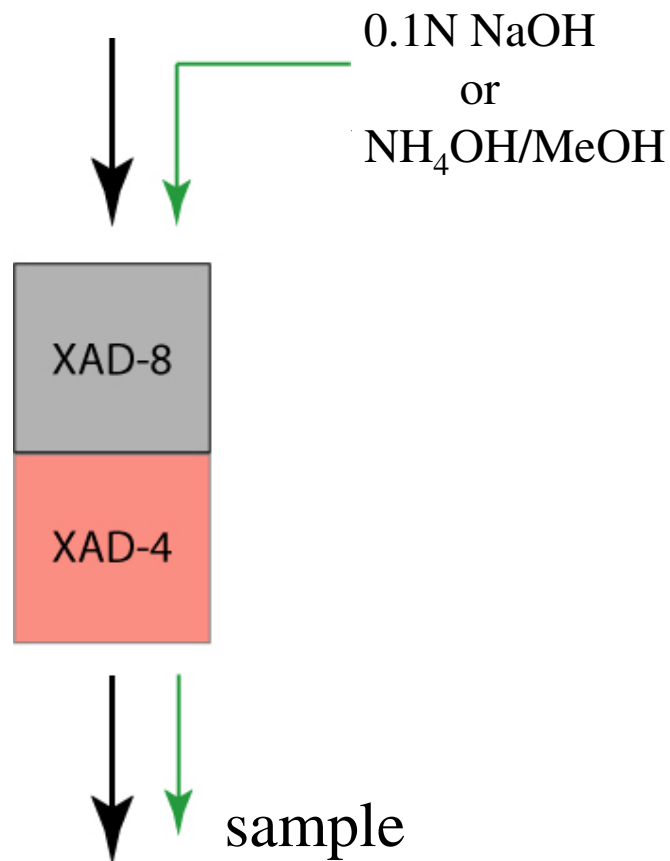

1. Chemical basis for sampling
2. Hydrophobic compounds
3. 5-10% of DOM
4. Old RC age

Humic substance in Amazon River water

Sample	%OC	C/N	H/C	CH _x	HCOH	C=C	COO	HC=O	C-13
Rio Negro FA	52.1	85.0	0.95	32	15	33	16	4	-29.0
Rio Negro HA	52.0	58.1	0.79	27	9	41	18	6	-29.2
main branch FA	51.4	60.0	1.00	32	13	31	17	7	-29.0

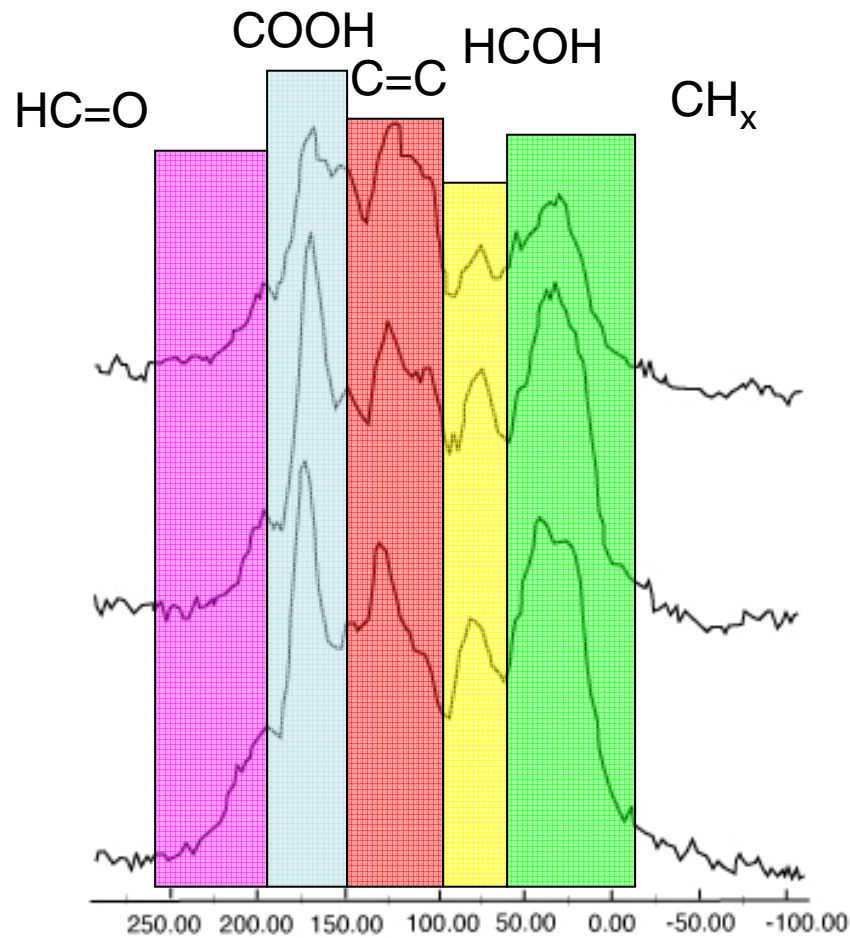

The characteristics of humic substances in the Amazon River and North Pacific Ocean

Image and tables removed due to copyright restrictions.

Image from Hedges, et al. "A comparison of dissolved humic substances from seawater with Amazon River counterparts by ^{13}C -NMR spectrometry."

Geochimica et Cosmochimica Acta 56, no. 4: 1753-1757.

Charts removed due to copyright restrictions.

From Hedges, et al. "A comparison of dissolved humic substances from seawater with Amazon River counterparts by ^{13}C -NMR spectrometry." *Geochimica et Cosmochimica Acta* 56, no. 4: 1753-1757.

A comparison of humic substances and HMWDOM in seawater

Humic substances

5-10% of DOC

C/N = 40

lots of aromatic C

“hydrophobic”

random assemblage ?

HMWDOC

25-35% of DOC

C/N = 15

little aromatic C

hydrophilic

fixed composition ?

Radiocarbon in riverine DOC...ages vary from
Very new to old, pre-bomb values....

Concentrations and Isotope Data for Riverine DOC

River	Date	DOC (μM)	$\Delta^{14}\text{C}$ (‰)	Radiocarbon age (yr BP)	$\Delta^{13}\text{C}$ (‰)
Amazon	11/91	235	28 ± 6	Modern	-28.0
Hudson	06/98	196	-158 ± 7	1,384	-25.5
York	09/96	701	216 ± 5	Modern	-28.8
	11/96	443	208 ± 5	Modern	-27.9
	03/97	390	257 ± 7	Modern	-28.0
	06/97	435	159 ± 5	Modern	-28.0
Parker	06/98	986	109 ± 6	Modern	-28.3
Potomac*	1972	360	+161	Modern	-30.9
Susquehama*	1972	292	-81	680	ND
Rapphannock*	1973	125	-91	766	-31.9
James*	1973	167	+42	Modern	-28.0

Values of $\Delta^{14}\text{C}$ are expressed as the deviation in parts per thousand (‰) from the ^{14}C activity of nineteenth century wood. $\delta^{13}\text{C}$ values are expressed as $(R_{\text{source}}/R_{\text{standards}})-1) \times 10^3$ in ‰, where $R = ^{13}\text{C}/^{12}\text{C}$, and the standard is the Pee Dee Belemnite, DOC samples (100ml of 0.7- μm -filtered river water) were oxidized to CO_2 samples were then converted to graphite and analysed for $\Delta^{14}\text{C}$ by accelerator mass spectrometry (AMS)³⁰. All $\Delta^{14}\text{C}$ values were corrected for sample $\delta^{13}\text{C}$. Errors ($\pm 1\sigma$) associated with $\Delta^{14}\text{C}$ AMS analyses averaged $\pm 6\text{‰}$ (± 60 years for radiocarbon age), while those for $\delta^{13}\text{C}$ analyses averaged $\pm 0.1\text{‰}$. Concentrations of DOC were determined as part of the UV oxidation and CO_2 purification procedure, with quantification by a positive pressure (Baratron) gauge. The average error ($\pm 1\sigma$) for DOC concentrations determined by this method was $\pm 1\mu\text{M}$, ND, not determined.

*Values from ref. 10, standard deviation not available.

Figure by MIT OCW.

Concentrations and Isotope Data for Riverine POC

River	Date	POC (μM)	$\Delta^{14}\text{C}$ (‰)	Radiocarbon age (yr BP)	$\Delta^{13}\text{C}$ (‰)
Amazon	11/91	52	-145 ± 6	1,258	-25.6
Hudson	06/98	118	-447 ± 7	4,763	ND
	10/98	43	426 ± 5	4,458	ND
	09/96	70	24 ± 5	Modern	ND
York	11/96	30	-38 ± 7	316	-28.2
	06/98	218	-190 ± 5	1,690	-30.0
	06/98	208	-85 ± 6	715	-30.0
Parker	10/98	75	-190 ± 6	1,696	-33.7

Suspended POC samples were collected by filtering river water through a baked ($>55^\circ\text{C}$) 0.7-mm glass -fiber filter. Filters were exposed to fuming HCl to remove carbonates before analysis, thoroughly dried, and processed by sealed quartz-tube combustion (900°C using a CuO/Ag metal catalyst) to produce CO_2 . Procedures and errors associated with POC, $\delta^{14}\text{C}$ and $\delta^{13}\text{C}$ analyses averaged $\pm 17\%$ (+160 yr for radiocarbon age), while those for ^{13}C analyses $\pm 0.1\%$. ND, not determined.

In situ production of DOC by marine microbes

Dissolved Organic Carbon and Red Tide in La Jolla Bay

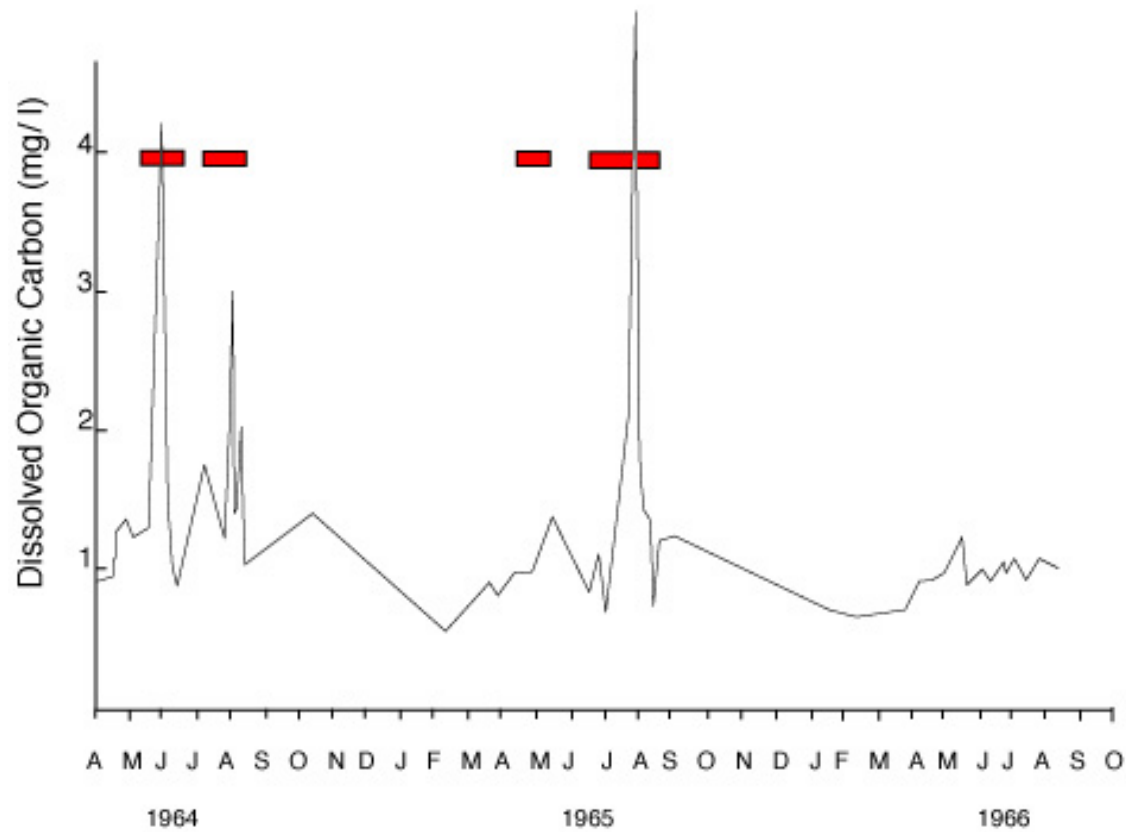

[DOC] can vary in space and time in the ocean due
To changes in DOC inventory (sources)

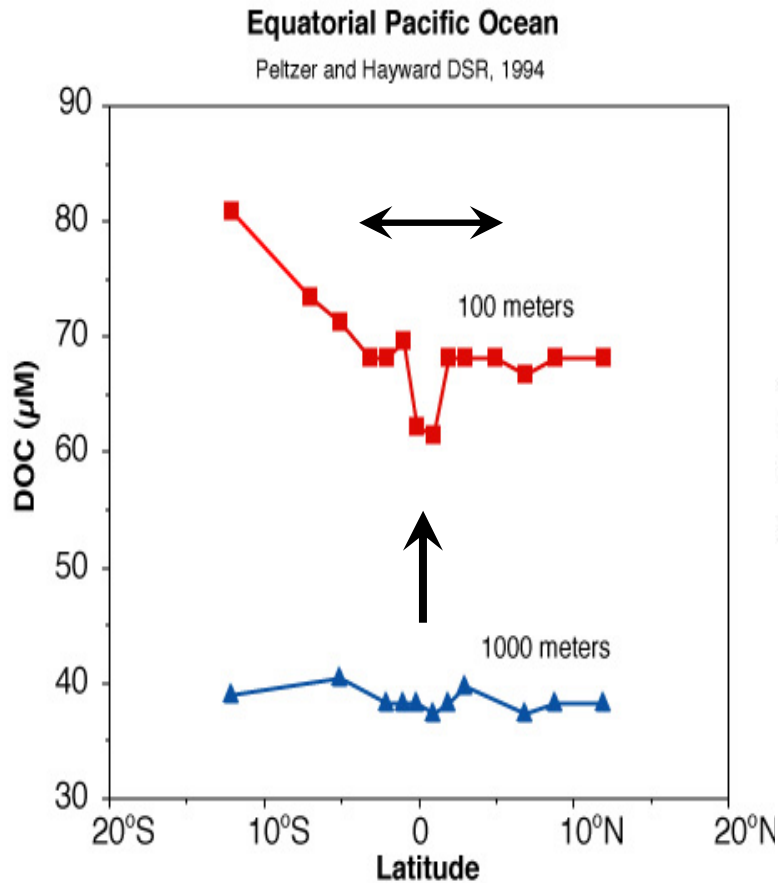

Seasonal production of DOC at the Bermuda Atlantic Time Series (BATS) site.

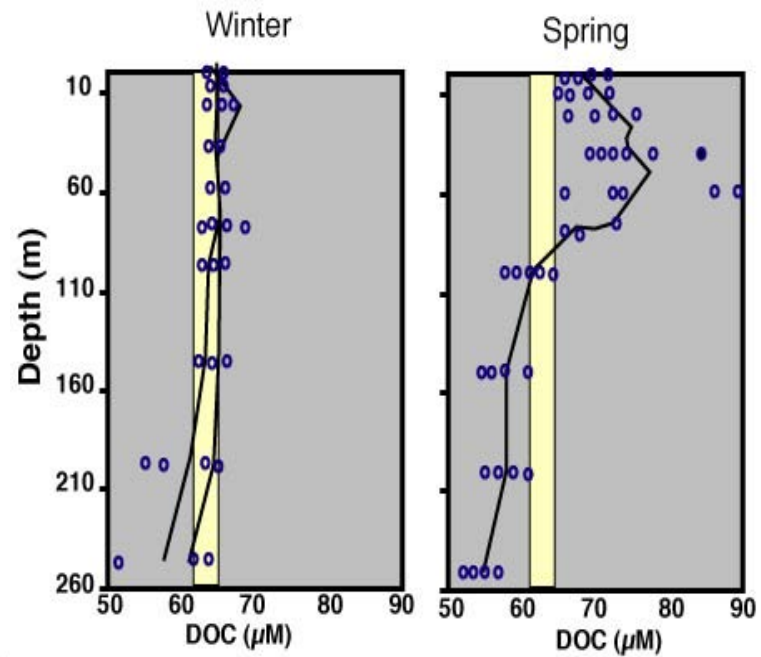

Production of DOC by phytoplankton in laboratory culture

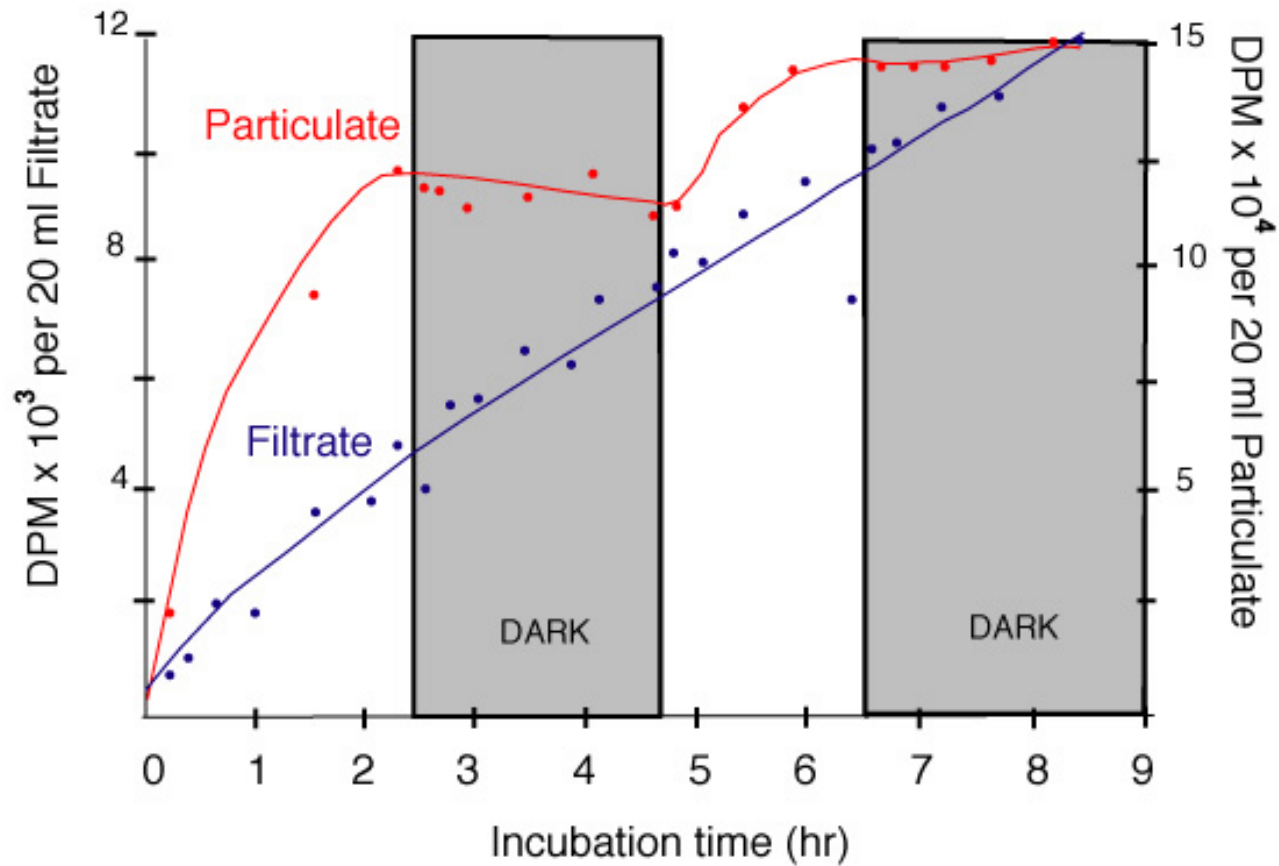

Mague et al, 197X

Photosynthesis and excretion of photosynthetic products during logarithmic growth of axenic algal cultures

Dunaliella tertiolecta

Hours	90	114	138	152
POM	9600	38600	103000	280000
DOM	373	1360	4140	11400
DOM(% total)	3.7	3.4	3.8	3.9

Skeletonema costatum

Hours	90	114	138	152
POM	9190	46400	116000	484000
DOM	457	1230	6700	28200
DOM (% total)	4.7	2.6	5.5	5.5

Monochrysis lutheri

Hours	59	71	83	108	120	163
cells/ml	6530	11700	20200	57000	90500	576000
POM	3680	7070	12800	43200	68000	353000
DOM	86	134	320	1110	1710	10000
DOM (% total)	2.3	1.9	2.4	2.5	2.5	2.8

Rate of CO₂ fixation and excretion of photosynthetic products

Incubation time	depth	Total CO ₂ fixation (μg C/l day)	Excretion (μg C/l day)	%Excretion
6/9				
07:45-12:30	0	5.7	<0.04	<1
	10	5.4	<0.04	<1
	50	7.0	<0.04	<1
13:15-17:55	0	6.7	0.11	1.6
	10	6.1	0.13	2.1
	50	12.7	1.30	10
6/11				
15:00-19:45	0	3.3	0.55	17
	10	2.2	0.50	23
	50	2.3	0.37	16
6/12				
08:00-13:00	0	4.1	0.42	10
	10	3.1	0.09	3
	50	6.9	0.41	6
7/23				
08:15-15:15	0	3.1	0.25	8
	10	2.2	0.20	9
	50	3.4	0.22	7
14:10-19:10	0	1.7	0.04	2
	10	2.5	0.06	3
	50	3.5	0.14	4
7/24				
09:00-13:30	0	2.5	0.10	4
	10	3.0	0.36	12
	50	2.6	0.17	7
		4.3	0.26	7

Production of DOC during grazing by macrozooplankton

Production of DOC in laboratory culture grazing experiments

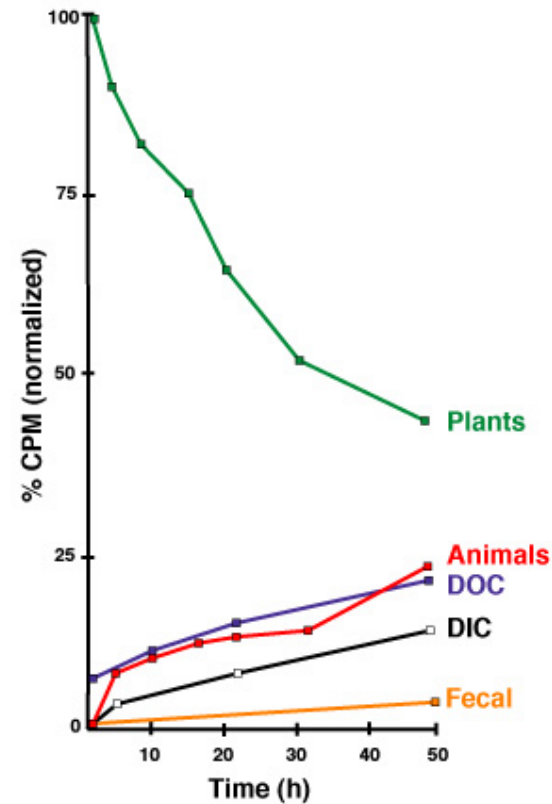
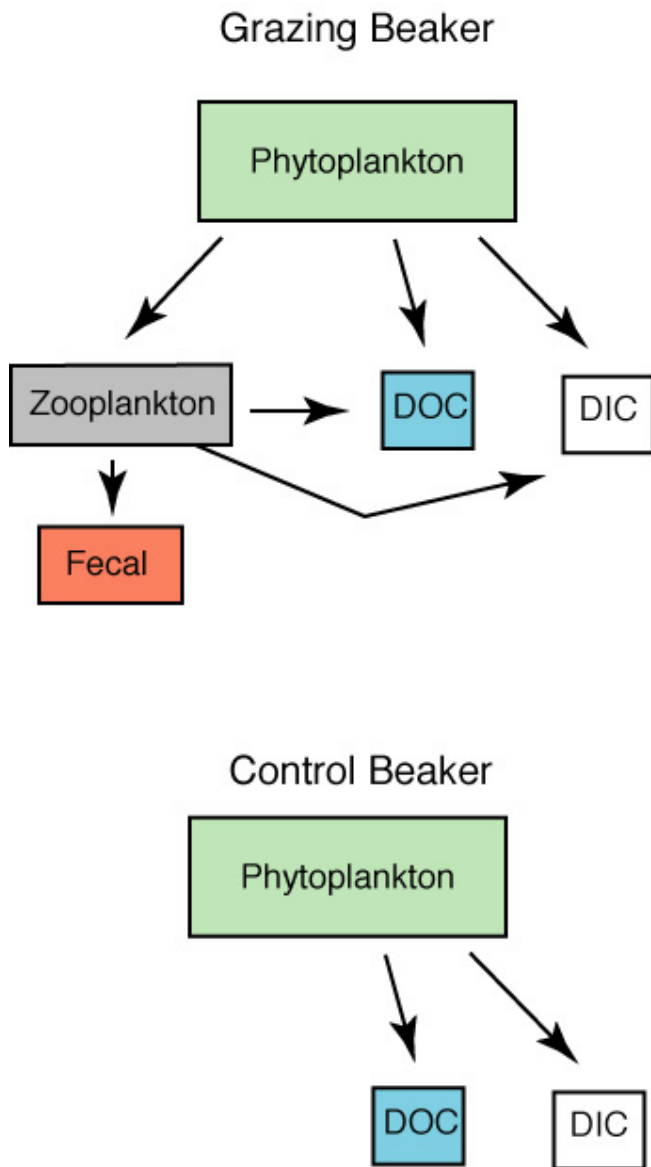

^{14}C activity with time for *Calanus pacificus* feeding on labeled *Thalassiosira fluviatilis*.

Production of DOC by phytoplankton

Obvious source of DOC in the ocean. Supported by stable isotope measurements of DOC- ^{13}C (-21‰). However, bacteria have also been cited as an important source for DOC. Which is it? *Why does DOC produced by algae or bacteria persist for 6000 yr when the ocean is SO efficient at removing C, N, P...*

If annual production is 75 GT C yr⁻¹, then only a small fraction is needed to support the global DOC cycle. Cultures and field studies yield about 5-10% of C fixed.

However, in surface water there is a large reservoir of “new” DOC that accumulates above deep water values. The flux of DOC needed to support that reservoir (30 GT C) depends on the residence time of new DOC.