

Basic Analysis II

Introduction to Real Analysis, Volume II

by Jiří Lebl

November 9, 2021
(version 2.5)

Typeset in L^AT_EX.

Copyright ©2012–2021 Jiří Lebl



This work is dual licensed under the Creative Commons Attribution-Noncommercial-Share Alike 4.0 International License and the Creative Commons Attribution-Share Alike 4.0 International License. To view a copy of these licenses, visit <https://creativecommons.org/licenses/by-nc-sa/4.0/> or <https://creativecommons.org/licenses/by-sa/4.0/> or send a letter to Creative Commons PO Box 1866, Mountain View, CA 94042, USA.

You can use, print, duplicate, share this book as much as you want. You can base your own notes on it and reuse parts if you keep the license the same. You can assume the license is either the CC-BY-NC-SA or CC-BY-SA, whichever is compatible with what you wish to do, your derivative works must use at least one of the licenses. Derivative works must be prominently marked as such.

During the writing of these notes, the author was in part supported by NSF grant DMS-1362337.

The date is the main identifier of version. The major version / edition number is raised only if there have been substantial changes. Each volume has its own version number.

See <https://www.jirka.org/ra/> for more information (including contact information, possible updates and errata).

The L^AT_EX source for the book is available for possible modification and customization at github: <https://github.com/jirilebl/ra>

Contents

Introduction	5
8 Several Variables and Partial Derivatives	7
8.1 Vector spaces, linear mappings, and convexity	7
8.2 Analysis with vector spaces	19
8.3 The derivative	32
8.4 Continuity and the derivative	42
8.5 Inverse and implicit function theorems	47
8.6 Higher order derivatives	56
9 One-dimensional Integrals in Several Variables	61
9.1 Differentiation under the integral	61
9.2 Path integrals	66
9.3 Path independence	77
10 Multivariable Integral	85
10.1 Riemann integral over rectangles	85
10.2 Iterated integrals and Fubini theorem	96
10.3 Outer measure and null sets	101
10.4 The set of Riemann integrable functions	109
10.5 Jordan measurable sets	113
10.6 Green's theorem	117
10.7 Change of variables	121
11 Functions as Limits	125
11.1 Complex numbers	125
11.2 Swapping limits	130
11.3 Power series and analytic functions	138
11.4 The complex exponential and the trigonometric functions	147
11.5 Fundamental theorem of algebra	153
11.6 Equicontinuity and the Arzelà–Ascoli theorem	156
11.7 The Stone–Weierstrass theorem	162
11.8 Fourier series	174
Further Reading	187

Index	189
List of Notation	193

Introduction

About this book

This second volume of “Basic Analysis” is meant to be a seamless continuation. The chapters are numbered to start where the first volume left off. The book started with my notes for a second-semester undergraduate analysis at University of Wisconsin—Madison in 2012, where I used my notes together with Rudin’s book. The choice of some of the material and some of the proofs are very similar to Rudin, though I do try to provide more detail and context. In 2016, I taught a second-semester undergraduate analysis at Oklahoma State University and heavily modified and cleaned up the notes, this time using them as the main text. In 2018, I taught this course again, this time adding chapter 11 (which I originally wrote for the Wisconsin course).

I plan to eventually add some more topics. I will try to preserve the current numbering in subsequent editions as always. The new topics I have planned would add chapters onto the end of the book, or add sections to end of existing chapters, and I will try as hard as possible to leave exercise numbers unchanged.

For the most part, this second volume depends on the non-optional parts of volume I, while some of the optional parts are also used. Higher order derivatives (but not Taylor’s theorem itself) are used in 8.6, 9.3, 10.6. Exponentials, logarithms, and improper integrals are used in a few examples and exercises, and they are heavily used in chapter 11.

My own plan for a two-semester course is that some bits of the first volume, such as metric spaces, are covered in the second semester, while some of the optional topics of volume I are covered in the first semester. Leaving metric spaces for the second semester makes more sense as then the second semester is the “multivariable” part of the course. Another possibility for a faster course is to leave out some of the optional parts, go quicker in the first semester including metric spaces and then arrive at chapter 11.

Several possibilities for things to cover after metric spaces, depending on time are:

- 1) 8.1–8.5, 10.1–10.5, 10.7 (multivariable calculus, focus on multivariable integral).
- 2) Chapter 8, chapter 9, 10.1 and 10.2 (multivariable calculus, focus on path integrals).
- 3) Chapters 8, 9, and 10 (multivariable calculus, path integrals, multivariable integrals).
- 4) Chapters 8, (maybe 9), and 11 (multivariable differential calculus, some advanced analysis).
- 5) Chapter 8, chapter 9, 11.1, 11.6, 11.7 (a simpler variation of the above).

Chapter 8

Several Variables and Partial Derivatives

8.1 Vector spaces, linear mappings, and convexity

Note: 2–3 lectures

8.1.1 Vector spaces

The euclidean space \mathbb{R}^n has already made an appearance in the metric space chapter. In this chapter, we extend the differential calculus we created for one variable to several variables. The key idea in differential calculus is to approximate differentiable functions by linear functions (approximating the graph by a straight line). In several variables, we must introduce a little bit of linear algebra before we can move on. We start with vector spaces and linear mappings on vector spaces.

While it is common to use \vec{v} or the bold \mathbf{v} for elements of \mathbb{R}^n , especially in the applied sciences, we use just plain old v , which is common in mathematics. That is, $v \in \mathbb{R}^n$ is a *vector*, which means $v = (v_1, v_2, \dots, v_n)$ is an n -tuple of real numbers.* It is common to write and treat vectors as *column vectors*, that is, n -by-1 matrices:

$$v = (v_1, v_2, \dots, v_n) = \begin{bmatrix} v_1 \\ v_2 \\ \vdots \\ v_n \end{bmatrix}$$

We will do so when convenient. We call real numbers *scalars* to distinguish them from vectors.

We often think of vectors as a direction and a magnitude and draw the vector as an arrow. The vector (v_1, v_2, \dots, v_n) is represented by an arrow from the origin to the point (v_1, v_2, \dots, v_n) , see [Figure 8.1](#) in the plane \mathbb{R}^2 . When we think of vectors as arrows, they are not based at the origin necessarily; a vector is simply the direction and the magnitude, and it does not know where it starts.

On the other hand, each vector also represents a point in \mathbb{R}^n . Usually, we think of $v \in \mathbb{R}^n$ as a point if we are thinking of \mathbb{R}^n as a metric space, and we think of it as an arrow if we think of the so-called *vector space structure* on \mathbb{R}^n (addition and scalar multiplication). Let us define the abstract notion of a vector space, as there are many other vector spaces than just \mathbb{R}^n .

*Subscripts are used for many purposes, so sometimes we may have several vectors that may also be identified by subscript, such as a finite or infinite sequence of vectors y_1, y_2, \dots

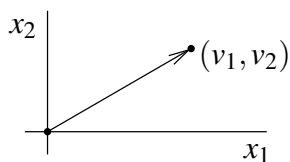

Figure 8.1: Vector as an arrow.

Definition 8.1.1. Let X be a set together with the operations of addition, $+: X \times X \rightarrow X$, and multiplication, $\cdot: \mathbb{R} \times X \rightarrow X$, (we usually write ax instead of $a \cdot x$). X is called a *vector space* (or a *real vector space*) if the following conditions are satisfied:

- | | |
|---------------------------------------|--|
| (i) (Addition is associative) | If $u, v, w \in X$, then $u + (v + w) = (u + v) + w$. |
| (ii) (Addition is commutative) | If $u, v \in X$, then $u + v = v + u$. |
| (iii) (Additive identity) | There is a $0 \in X$ such that $v + 0 = v$ for all $v \in X$. |
| (iv) (Additive inverse) | For every $v \in X$, there is a $-v \in X$, such that $v + (-v) = 0$. |
| (v) (Distributive law) | If $a \in \mathbb{R}$, $u, v \in X$, then $a(u + v) = au + av$. |
| (vi) (Distributive law) | If $a, b \in \mathbb{R}$, $v \in X$, then $(a + b)v = av + bv$. |
| (vii) (Multiplication is associative) | If $a, b \in \mathbb{R}$, $v \in X$, then $(ab)v = a(bv)$. |
| (viii) (Multiplicative identity) | $1v = v$ for all $v \in X$. |

Elements of a vector space are usually called *vectors*, even if they are not elements of \mathbb{R}^n (vectors in the “traditional” sense).

If $Y \subset X$ is a subset that is a vector space itself using the same operations, then Y is called a *subspace* or a *vector subspace* of X .

Multiplication by scalars works as one would expect. For example, $2v = (1 + 1)v = 1v + 1v = v + v$, similarly $3v = v + v + v$, and so on. One particular fact we often use is that $0v = 0$, where the zero on the left is $0 \in \mathbb{R}$ and the zero on the right is $0 \in X$. To see this start with $0v = (0 + 0)v = 0v + 0v$, and add $-(0v)$ to both sides to obtain $0 = 0v$. Similarly $-v = (-1)v$, which follows by $(-1)v + v = (-1)v + 1v = (-1 + 1)v = 0v = 0$. These algebraic facts which follow quickly from the definition we will take for granted from now on.

Example 8.1.2: An example vector space is \mathbb{R}^n , where addition and multiplication by a scalar is done componentwise: If $a \in \mathbb{R}$, $v = (v_1, v_2, \dots, v_n) \in \mathbb{R}^n$, and $w = (w_1, w_2, \dots, w_n) \in \mathbb{R}^n$, then

$$v + w := (v_1, v_2, \dots, v_n) + (w_1, w_2, \dots, w_n) = (v_1 + w_1, v_2 + w_2, \dots, v_n + w_n),$$

$$av := a(v_1, v_2, \dots, v_n) = (av_1, av_2, \dots, av_n).$$

In this book, we mostly deal with vector spaces that can be often regarded as subsets of \mathbb{R}^n , but there are other vector spaces useful in analysis. Let us give a couple of examples.

Example 8.1.3: A trivial example of a vector space is just $X := \{0\}$. The operations are defined in the obvious way: $0 + 0 := 0$ and $a0 := 0$. A zero vector must always exist, so all vector spaces are nonempty sets, and this X is the smallest possible vector space.

Example 8.1.4: The space $C([0, 1], \mathbb{R})$ of continuous functions on the interval $[0, 1]$ is a vector space. For two functions f and g in $C([0, 1], \mathbb{R})$ and $a \in \mathbb{R}$, we make the obvious definitions of $f + g$ and af :

$$(f + g)(x) := f(x) + g(x), \quad (af)(x) := a(f(x)).$$

The 0 is the function that is identically zero. We leave it as an exercise to check that all the vector space conditions are satisfied.

The space $C^1([0, 1], \mathbb{R})$ of continuously differentiable functions is a subspace of $C([0, 1], \mathbb{R})$.

Example 8.1.5: The space of polynomials $c_0 + c_1t + c_2t^2 + \cdots + c_mt^m$ (of arbitrary degree m) is a vector space. Let us denote it by $\mathbb{R}[t]$ (coefficients are real and the variable is t). The operations are defined in the same way as for functions above. Suppose there are two polynomials, one of degree m and one of degree n . Assume $n \geq m$ for simplicity. Then

$$\begin{aligned} (c_0 + c_1t + c_2t^2 + \cdots + c_mt^m) + (d_0 + d_1t + d_2t^2 + \cdots + d_nt^n) = \\ (c_0 + d_0) + (c_1 + d_1)t + (c_2 + d_2)t^2 + \cdots + (c_m + d_m)t^m + d_{m+1}t^{m+1} + \cdots + d_nt^n \end{aligned}$$

and

$$a(c_0 + c_1t + c_2t^2 + \cdots + c_mt^m) = (ac_0) + (ac_1)t + (ac_2)t^2 + \cdots + (ac_m)t^m.$$

Despite what it looks like, $\mathbb{R}[t]$ is not equivalent to \mathbb{R}^n for any n . In particular, it is not “finite-dimensional.” We will make this notion precise in just a little bit. One can make a finite-dimensional vector subspace by restricting the degree. For example, if \mathcal{P}_n is the set of polynomials of degree n or less, then \mathcal{P}_n is a finite-dimensional vector space, and we could identify it with \mathbb{R}^{n+1} .

In the above, the variable t is really just a formal placeholder. By setting t equal to a real number we obtain a function. So the space $\mathbb{R}[t]$ can be thought of as a subspace of $C(\mathbb{R}, \mathbb{R})$. If we restrict the range of t to $[0, 1]$, $\mathbb{R}[t]$ can be identified with a subspace of $C([0, 1], \mathbb{R})$.

Remark 8.1.6. If X is a vector space, to check that a subset $S \subset X$ is a vector subspace, we only need

- 1) $0 \in S$,
- 2) S is closed under addition, adding two vectors in S gets us a vector in S , and
- 3) S is closed under scalar multiplication, multiplying a vector in S by a scalar gets us a vector in S .

Items 2) and 3) make sure that the addition and scalar multiplication are indeed defined on S . Item 1) is required to fulfill item (iii) from the definition of vector space. Existence of additive inverse $-v$ follows because $-v = (-1)v$ and item 3) says that $-v \in S$ if $v \in S$. All other properties are certain equalities which are already satisfied in X and thus must be satisfied in a subset.

It is often better to think of even the simpler “finite-dimensional” vector spaces using the abstract notion rather than always as \mathbb{R}^n . It is possible to use other fields than \mathbb{R} in the definition (for example it is common to use the complex numbers \mathbb{C}), but let us stick with the real numbers*.

*If you want a very funky vector space over a different field, \mathbb{R} itself is a vector space over the rational numbers.

8.1.2 Linear combinations and dimension

Definition 8.1.7. Suppose X is a vector space, $x_1, x_2, \dots, x_k \in X$ are vectors, and $a_1, a_2, \dots, a_k \in \mathbb{R}$ are scalars. Then

$$a_1x_1 + a_2x_2 + \dots + a_kx_k$$

is called a *linear combination* of the vectors x_1, x_2, \dots, x_k .

If $Y \subset X$ is a set, then the *span* of Y , or in notation $\text{span}(Y)$, is the set of all linear combinations of all finite subsets of Y . We say Y *spans* $\text{span}(Y)$.

Example 8.1.8: Let $Y := \{(1, 1)\} \subset \mathbb{R}^2$. Then

$$\text{span}(Y) = \{(x, x) \in \mathbb{R}^2 : x \in \mathbb{R}\}.$$

That is, $\text{span}(Y)$ is the line through the origin and the point $(1, 1)$.

Example 8.1.9: Let $Y := \{(1, 1), (0, 1)\} \subset \mathbb{R}^2$. Then

$$\text{span}(Y) = \mathbb{R}^2,$$

as every point $(x, y) \in \mathbb{R}^2$ can be written as a linear combination

$$(x, y) = x(1, 1) + (y - x)(0, 1).$$

Example 8.1.10: Let $Y := \{1, t, t^2, t^3, \dots\} \subset \mathbb{R}[t]$, and $E := \{1, t^2, t^4, t^6, \dots\} \subset \mathbb{R}[t]$.

The span of Y is all polynomials,

$$\text{span}(Y) = \mathbb{R}[t].$$

The span of E is the set of polynomials with even powers of t only.

Suppose we have two linear combinations of vectors from Y . One linear combination uses the vectors $\{x_1, x_2, \dots, x_k\}$, and the other uses $\{\tilde{x}_1, \tilde{x}_2, \dots, \tilde{x}_\ell\}$. Then clearly we can write both linear combinations using vectors from the union $\{x_1, x_2, \dots, x_k\} \cup \{\tilde{x}_1, \tilde{x}_2, \dots, \tilde{x}_\ell\}$, by just taking zero multiples of the vectors we do not need, e.g. $x_1 = x_1 + 0\tilde{x}_1$. Suppose we have two linear combinations, we can without loss of generality write them as a linear combination of x_1, x_2, \dots, x_k . Then their sum is also a linear combination of vectors from Y :

$$\begin{aligned} (a_1x_1 + a_2x_2 + \dots + a_kx_k) + (b_1x_1 + b_2x_2 + \dots + b_kx_k) \\ = (a_1 + b_1)x_1 + (a_2 + b_2)x_2 + \dots + (a_k + b_k)x_k. \end{aligned}$$

Similarly a scalar multiple of a linear combination of vectors from Y is a linear combination of vectors from Y :

$$b(a_1x_1 + a_2x_2 + \dots + a_kx_k) = ba_1x_1 + ba_2x_2 + \dots + ba_kx_k.$$

We formalize this statement in a proposition.

Proposition 8.1.11. *Let X be a vector space. For every $Y \subset X$, the set $\text{span}(Y)$ is a vector space. That is, $\text{span}(Y)$ is a subspace of X .*

If Y is already a vector space, then $\text{span}(Y) = Y$.

Definition 8.1.12. A set of vectors $\{x_1, x_2, \dots, x_k\} \subset X$ is *linearly independent*^{*} if the equation

$$a_1x_1 + a_2x_2 + \dots + a_kx_k = 0 \quad (8.1)$$

has only the trivial solution $a_1 = a_2 = \dots = a_k = 0$. A set that is not linearly independent is *linearly dependent*. A linearly independent set of vectors B such that $\text{span}(B) = X$ is called a *basis* of X .

If a vector space X contains a linearly independent set of d vectors, but no linearly independent set of $d + 1$ vectors, then we say the *dimension* of X is d , and we write $\dim X := d$. If for all $d \in \mathbb{N}$ the vector space X contains a set of d linearly independent vectors, we say X is infinite-dimensional and write $\dim X := \infty$. For the trivial vector space $\{0\}$, we define $\dim \{0\} := 0$.

A subset of a linear independent set is clearly linearly independent, so in the definition of dimension, notice that if a set does not have $d + 1$ linearly independent vectors, no set of more than $d + 1$ vectors is linearly independent either.

As an example, the set Y of the two vectors in [Example 8.1.9](#) is a basis of \mathbb{R}^2 , and so $\dim \mathbb{R}^2 \geq 2$. We will see in a moment that every vector subspace of \mathbb{R}^n has a finite dimension, and that dimension is less than or equal to n . So every set of 3 vectors in \mathbb{R}^2 is linearly dependent, and $\dim \mathbb{R}^2 = 2$.

If a set is linearly dependent, then one of the vectors is a linear combination of the others. In other words, in (8.1) if $a_j \neq 0$, then we solve for x_j :

$$x_j = \frac{-a_1}{a_j}x_1 + \dots + \frac{-a_{j-1}}{a_j}x_{j-1} + \frac{-a_{j+1}}{a_j}x_{j+1} + \dots + \frac{-a_k}{a_j}x_k.$$

The vector x_j has at least two different representations as linear combinations of $\{x_1, x_2, \dots, x_k\}$. The one above and x_j itself. For example, the set $\{(0, 1), (2, 3), (5, 0)\}$ in \mathbb{R}^2 is linearly dependent:

$$3(0, 1) - (2, 3) + 2(1, 0) = 0, \quad \text{so} \quad (2, 3) = 3(0, 1) + 2(1, 0).$$

Proposition 8.1.13. Suppose a vector space X has basis $B = \{x_1, x_2, \dots, x_k\}$. Then every $y \in X$ has a unique representation of the form

$$y = \sum_{j=1}^k a_j x_j$$

for some scalars a_1, a_2, \dots, a_k .

Proof. As X is the span of B , every $y \in X$ is a linear combination of elements of B . Suppose

$$y = \sum_{j=1}^k a_j x_j = \sum_{j=1}^k b_j x_j.$$

Then

$$\sum_{j=1}^k (a_j - b_j)x_j = 0.$$

By linear independence of the basis $a_j = b_j$ for all j , and so the representation is unique. \square

^{*}For an infinite set $Y \subset X$, we would say Y is linearly independent if every finite subset of Y is linearly independent in the sense given. However, this situation only comes up in infinitely many dimensions and we will not require it.

For \mathbb{R}^n we define the *standard basis* of \mathbb{R}^n :

$$e_1 := (1, 0, 0, \dots, 0), \quad e_2 := (0, 1, 0, \dots, 0), \quad \dots, \quad e_n := (0, 0, 0, \dots, 1),$$

We use the same letters e_j for any \mathbb{R}^n , and which space \mathbb{R}^n we are working in is understood from context. A direct computation shows that $\{e_1, e_2, \dots, e_n\}$ is really a basis of \mathbb{R}^n ; it spans \mathbb{R}^n and is linearly independent. In fact,

$$a = (a_1, a_2, \dots, a_n) = \sum_{j=1}^n a_j e_j.$$

Proposition 8.1.14. *Let X be a vector space and d a nonnegative integer.*

- (i) *If X is spanned by d vectors, then $\dim X \leq d$.*
- (ii) *$\dim X = d$ if and only if X has a basis of d vectors (and so every basis has d vectors).*
- (iii) *In particular, $\dim \mathbb{R}^n = n$.*
- (iv) *If $Y \subset X$ is a vector subspace and $\dim X = d$, then $\dim Y \leq d$.*
- (v) *If $\dim X = d$ and a set T of d vectors spans X , then T is linearly independent.*
- (vi) *If $\dim X = d$ and a set T of m vectors is linearly independent, then there is a set S of $d - m$ vectors such that $T \cup S$ is a basis of X .*

Proof. Let us start with (i). Suppose $S = \{x_1, x_2, \dots, x_d\}$ spans X , and $T = \{y_1, y_2, \dots, y_m\}$ is a set of linearly independent vectors of X . We wish to show that $m \leq d$. Write

$$y_1 = \sum_{k=1}^d a_{k,1} x_k,$$

for some numbers $a_{1,1}, a_{2,1}, \dots, a_{d,1}$, which we can do as S spans X . One of the $a_{k,1}$ is nonzero (otherwise y_1 would be zero), so suppose without loss of generality that this is $a_{1,1}$. Then we solve

$$x_1 = \frac{1}{a_{1,1}} y_1 - \sum_{k=2}^d \frac{a_{k,1}}{a_{1,1}} x_k.$$

In particular, $\{y_1, x_2, \dots, x_d\}$ span X , since x_1 can be obtained from $\{y_1, x_2, \dots, x_d\}$. Therefore, there are some numbers for some numbers $a_{1,2}, a_{2,2}, \dots, a_{d,2}$, such that

$$y_2 = a_{1,2} y_1 + \sum_{k=2}^d a_{k,2} x_k.$$

As T is linearly independent, one of the $a_{k,2}$ for $k \geq 2$ must be nonzero. Without loss of generality suppose $a_{2,2} \neq 0$. Proceed to solve for

$$x_2 = \frac{1}{a_{2,2}} y_2 - \frac{a_{1,2}}{a_{2,2}} y_1 - \sum_{k=3}^d \frac{a_{k,2}}{a_{2,2}} x_k.$$

In particular, $\{y_1, y_2, x_3, \dots, x_d\}$ spans X .

We continue this procedure. If $m < d$, then we are done. So suppose $m \geq d$. After d steps, we obtain that $\{y_1, y_2, \dots, y_d\}$ spans X . Any other vector v in X is a linear combination of $\{y_1, y_2, \dots, y_d\}$, and hence cannot be in T as T is linearly independent. So $m = d$.

Let us look at (ii). First a short claim. If T is a set of k linearly independent vectors that do not span X , that is $X \setminus \text{span}(T) \neq \emptyset$, then choose a vector $v \in X \setminus \text{span}(T)$. The set $T \cup \{v\}$ is linearly independent: A nonzero linear combination of elements of $T \cup \{v\}$ would either produce v as a combination of T , or it would be a combination of elements of T , and neither option is possible.

If $\dim X = d$, then there must exist some linearly independent set of d vectors T , and it must span X , otherwise we could choose a larger set of linearly independent vectors. So we have a basis of d vectors. On the other hand, if we have a basis of d vectors, it is linearly independent and spans X by definition. By (i) we know there is no set of $d + 1$ linearly independent vectors, so the dimension of X must be d .

For (iii) notice that $\{e_1, e_2, \dots, e_n\}$ is a basis of \mathbb{R}^n .

To see (iv), suppose $Y \subset X$ is a vector subspace, where $\dim X = d$. As X cannot contain $d + 1$ linearly independent vectors, neither can Y .

For (v) suppose T is a set of m vectors that is linearly dependent and spans X , we will show that $m > d$. One of the vectors is a linear combination of the others. If we remove it from T we obtain a set of $m - 1$ vectors that still span X and hence $\dim X \leq m - 1$ by (i).

For (vi) suppose $T = \{x_1, x_2, \dots, x_m\}$ is a linearly independent set. Firstly, $m \leq d$. If $m = d$, we are done. Otherwise, we follow the procedure above in the proof of (ii) to add a vector v not in the span of T . The set $T \cup \{v\}$ is linearly independent, whose span has dimension $m + 1$. Therefore, we can repeat this procedure $d - m$ times before we find a set of d linearly independent vectors. They must span X otherwise we could add yet another vector. \square

8.1.3 Linear mappings

A function $f: X \rightarrow Y$, when Y is not \mathbb{R} , is often called a *mapping* or a *map* rather than a *function*.

Definition 8.1.15. A mapping $A: X \rightarrow Y$ of vector spaces X and Y is *linear* (we also say A is a *linear transformation* or a *linear operator*) if for all $a \in \mathbb{R}$ and all $x, y \in X$,

$$A(ax) = aA(x), \quad \text{and} \quad A(x + y) = A(x) + A(y).$$

We usually write Ax instead of $A(x)$ if A is linear. If A is one-to-one and onto, then we say A is *invertible*, and we denote the inverse by A^{-1} . If $A: X \rightarrow X$ is linear, then we say A is a *linear operator on X* .

We write $L(X, Y)$ for the set of all linear transformations from X to Y , and just $L(X)$ for the set of linear operators on X . If $a \in \mathbb{R}$ and $A, B \in L(X, Y)$, define the transformations aA and $A + B$ by

$$(aA)(x) := aAx, \quad (A + B)(x) := Ax + Bx.$$

If $A \in L(Y, Z)$ and $B \in L(X, Y)$, define the transformation AB as the composition $A \circ B$, that is,

$$ABx := A(Bx).$$

Finally, denote by $I \in L(X)$ the *identity*: the linear operator such that $Ix = x$ for all x .

It is not hard to see that $aA \in L(X, Y)$ and $A + B \in L(X, Y)$, and that $AB \in L(X, Z)$. In particular, $L(X, Y)$ is a vector space. As the set $L(X)$ is not only a vector space, but also admits a product (composition of operators), it is often called an *algebra*.

An immediate consequence of the definition of a linear mapping is: If A is linear, then $A0 = 0$.

Proposition 8.1.16. *If $A \in L(X, Y)$ is invertible, then A^{-1} is linear.*

Proof. Let $a \in \mathbb{R}$ and $y \in Y$. As A is onto, then there is an x such that $y = Ax$, and further as it is also one-to-one $A^{-1}(Az) = z$ for all $z \in X$. So

$$A^{-1}(ay) = A^{-1}(aAx) = A^{-1}(A(ax)) = ax = aA^{-1}(y).$$

Similarly let $y_1, y_2 \in Y$, and $x_1, x_2 \in X$ such that $Ax_1 = y_1$ and $Ax_2 = y_2$, then

$$A^{-1}(y_1 + y_2) = A^{-1}(Ax_1 + Ax_2) = A^{-1}(A(x_1 + x_2)) = x_1 + x_2 = A^{-1}(y_1) + A^{-1}(y_2). \quad \square$$

Proposition 8.1.17. *If $A \in L(X, Y)$ is linear, then it is completely determined by its values on a basis of X . Furthermore, if B is a basis of X , then every function $\tilde{A}: B \rightarrow Y$ extends to a linear function on X .*

We will only prove this proposition for finite-dimensional spaces, as we do not need infinite-dimensional spaces. For infinite-dimensional spaces, the proof is essentially the same, but a little trickier to write, so let us stick with finitely many dimensions.

Proof. Let $\{x_1, x_2, \dots, x_n\}$ be a basis of X , and let $y_j := Ax_j$. Every $x \in X$ has a unique representation

$$x = \sum_{j=1}^n b_j x_j$$

for some numbers b_1, b_2, \dots, b_n . By linearity

$$Ax = A \sum_{j=1}^n b_j x_j = \sum_{j=1}^n b_j Ax_j = \sum_{j=1}^n b_j y_j.$$

The “furthermore” follows by setting $y_j := \tilde{A}(x_j)$, and then for $x = \sum_{j=1}^n b_j x_j$, defining the extension as $Ax := \sum_{j=1}^n b_j y_j$. The function is well-defined by uniqueness of the representation of x . We leave it to the reader to check that A is linear. \square

The next proposition only works for finite-dimensional vector spaces. It is a special case of the so-called rank-nullity theorem from linear algebra.

Proposition 8.1.18. *If X is a finite-dimensional vector space and $A \in L(X)$, then A is one-to-one if and only if it is onto.*

Proof. Let $\{x_1, x_2, \dots, x_n\}$ be a basis for X . First suppose A is one-to-one. Let c_1, c_2, \dots, c_n be such that

$$\sum_{j=1}^n c_j Ax_j = A \sum_{j=1}^n c_j x_j = 0.$$

As A is one-to-one, the only vector that is taken to 0 is 0 itself. Hence,

$$0 = \sum_{j=1}^n c_j x_j$$

and $c_j = 0$ for all j . So $\{Ax_1, Ax_2, \dots, Ax_n\}$ is a linearly independent set. By [Proposition 8.1.14](#) and the fact that the dimension is n , we conclude $\{Ax_1, Ax_2, \dots, Ax_n\}$ spans X . Any point $x \in X$ can be written as

$$x = \sum_{j=1}^n a_j Ax_j = A \sum_{j=1}^n a_j x_j,$$

so A is onto.

For the other direction, suppose A is onto. As A is determined by the action on the basis, every element of X is in the span of $\{Ax_1, Ax_2, \dots, Ax_n\}$. Suppose that for some c_1, c_2, \dots, c_n ,

$$A \sum_{j=1}^n c_j x_j = \sum_{j=1}^n c_j Ax_j = 0.$$

By [Proposition 8.1.14](#) as $\{Ax_1, Ax_2, \dots, Ax_n\}$ span X , the set is linearly independent, and hence $c_j = 0$ for all j . In other words, if $Ax = 0$, then $x = 0$. This means that A is one-to-one: If $Ax = Ay$, then $A(x - y) = 0$ and so $x = y$. \square

We leave the proof of the next proposition as an exercise.

Proposition 8.1.19. *If X and Y are finite-dimensional vector spaces, then $L(X, Y)$ is also finite-dimensional.*

We often identify a finite-dimensional vector space X of dimension n with \mathbb{R}^n , provided we fix a basis $\{x_1, x_2, \dots, x_n\}$ in X . That is, we define a bijective linear map $A \in L(X, \mathbb{R}^n)$ by $Ax_j := e_j$, where $\{e_1, e_2, \dots, e_n\}$ is the standard basis in \mathbb{R}^n . Then we have the correspondence

$$\sum_{j=1}^n c_j x_j \in X \quad \xrightarrow{A} \quad (c_1, c_2, \dots, c_n) \in \mathbb{R}^n.$$

8.1.4 Convexity

A subset U of a vector space is *convex* if whenever $x, y \in U$, the line segment from x to y lies in U . That is, if the *convex combination* $(1-t)x + ty$ is in U for all $t \in [0, 1]$. Sometimes we write $[x, y]$ for this line segment. See [Figure 8.2](#).

In \mathbb{R} , convex sets are precisely the intervals, which are also precisely the connected sets. In two or more dimensions there are lots of nonconvex connected sets. For example, the set $\mathbb{R}^2 \setminus \{0\}$ is not convex, but it is connected. To see this, take any $x \in \mathbb{R}^2 \setminus \{0\}$ and let $y := -x$. Then $(1/2)x + (1/2)y = 0$, which is not in the set. Balls in \mathbb{R}^n are convex. We use this result often enough we state it as a proposition, and leave the proof as an exercise.

Proposition 8.1.20. *Let $x \in \mathbb{R}^n$ and $r > 0$. The ball $B(x, r) \subset \mathbb{R}^n$ (using the standard metric on \mathbb{R}^n) is convex.*

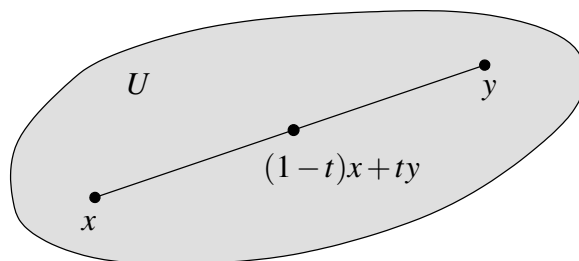

Figure 8.2: Convexity.

Example 8.1.21: As a convex combination is, in particular, a linear combination, so every subspace V of a vector space X is convex.

Example 8.1.22: Let $C([0, 1], \mathbb{R})$ be the vector space of continuous real-valued functions on \mathbb{R} . Let $X \subset C([0, 1], \mathbb{R})$ be the set of those f such that

$$\int_0^1 f(x) dx \leq 1 \quad \text{and} \quad f(x) \geq 0 \quad \text{for all } x \in [0, 1].$$

Then X is convex. Take $t \in [0, 1]$, and note that if $f, g \in X$, then $tf(x) + (1-t)g(x) \geq 0$ for all x . Furthermore

$$\int_0^1 (tf(x) + (1-t)g(x)) dx = t \int_0^1 f(x) dx + (1-t) \int_0^1 g(x) dx \leq 1.$$

Note that X is not a vector subspace of $C([0, 1], \mathbb{R})$. The function $f(x) := 1$ is in X , but $2f$ and $-f$ is not.

Proposition 8.1.23. *The intersection two convex sets is convex. In fact, if $\{C_\lambda\}_{\lambda \in I}$ is an arbitrary collection of convex sets, then*

$$C := \bigcap_{\lambda \in I} C_\lambda$$

is convex.

Proof. If $x, y \in C$, then $x, y \in C_\lambda$ for all $\lambda \in I$, and hence if $t \in [0, 1]$, then $tx + (1-t)y \in C_\lambda$ for all $\lambda \in I$. Therefore, $tx + (1-t)y \in C$ and C is convex. \square

Proposition 8.1.24. *Let $T: V \rightarrow W$ be a linear mapping between two vector spaces and let $C \subset V$ be a convex set. Then $T(C)$ is convex.*

Proof. Take two points $p, q \in T(C)$. Pick $x, y \in C$ such that $Tx = p$ and $Ty = q$. As C is convex, then $tx + (1-t)y \in C$ for all $t \in [0, 1]$, so

$$tp + (1-t)q = tTx + (1-t)Ty = T(tx + (1-t)y) \in T(C). \quad \square$$

For completeness, a very useful construction is the *convex hull*. Given a subset $S \subset V$ of a vector space, define the convex hull of S as the intersection of all convex sets containing S :

$$\text{co}(S) := \bigcap \{C \subset V : S \subset C, \text{ and } C \text{ is convex}\}.$$

That is, the convex hull is the smallest convex set containing S . By a proposition above, the intersection of convex sets is convex and hence, the convex hull is convex.

Example 8.1.25: The convex hull of $\{0, 1\}$ in \mathbb{R} is $[0, 1]$. Proof: Any convex set containing 0 and 1 must contain $[0, 1]$, so $[0, 1] \subset \text{co}(\{0, 1\})$. The set $[0, 1]$ is convex and contains $\{0, 1\}$, so $\text{co}(\{0, 1\}) \subset [0, 1]$.

8.1.5 Exercises

Exercise 8.1.1: Show that in \mathbb{R}^n (with the standard euclidean metric), for every $x \in \mathbb{R}^n$ and every $r > 0$, the ball $B(x, r)$ is convex.

Exercise 8.1.2: Verify that \mathbb{R}^n is a vector space.

Exercise 8.1.3: Let X be a vector space. Prove that a finite set of vectors $\{x_1, x_2, \dots, x_n\} \subset X$ is linearly independent if and only if for every $j = 1, 2, \dots, n$

$$\text{span}(\{x_1, \dots, x_{j-1}, x_{j+1}, \dots, x_n\}) \subsetneq \text{span}(\{x_1, x_2, \dots, x_n\}).$$

That is, the span of the set with one vector removed is strictly smaller.

Exercise 8.1.4: Show that the set $X \subset C([0, 1], \mathbb{R})$ of those functions such that $\int_0^1 f = 0$ is a vector subspace.

Exercise 8.1.5 (Challenging): Prove $C([0, 1], \mathbb{R})$ is an infinite-dimensional vector space where the operations are defined in the obvious way: $s = f + g$ and $m = af$ are defined as $s(x) := f(x) + g(x)$ and $m(x) := af(x)$. Hint: For the dimension, think of functions that are only nonzero on the interval $(1/n+1, 1/n)$.

Exercise 8.1.6: Let $k: [0, 1]^2 \rightarrow \mathbb{R}$ be continuous. Show that $L: C([0, 1], \mathbb{R}) \rightarrow C([0, 1], \mathbb{R})$ defined by

$$Lf(y) := \int_0^1 k(x, y)f(x) dx$$

is a linear operator. That is, first show that L is well-defined by showing that Lf is continuous whenever f is, and then showing that L is linear.

Exercise 8.1.7: Let \mathcal{P}_n be the vector space of polynomials in one variable of degree n or less. Show that \mathcal{P}_n is a vector space of dimension $n + 1$.

Exercise 8.1.8: Let $\mathbb{R}[t]$ be the vector space of polynomials in one variable t . Let $D: \mathbb{R}[t] \rightarrow \mathbb{R}[t]$ be the derivative operator (derivative in t). Show that D is a linear operator.

Exercise 8.1.9: Let us show that [Proposition 8.1.18](#) only works in finite dimensions. Take the space of polynomials $\mathbb{R}[t]$ and define the operator $A: \mathbb{R}[t] \rightarrow \mathbb{R}[t]$ by $A(P(t)) := tP(t)$. Show that A is linear and one-to-one, but show that it is not onto.

Exercise 8.1.10: Finish the proof of [Proposition 8.1.17](#) in the finite-dimensional case. That is, suppose, $\{x_1, x_2, \dots, x_n\}$ is a basis of X , $\{y_1, y_2, \dots, y_n\} \subset Y$ and we define a function

$$Ax := \sum_{j=1}^n b_j y_j, \quad \text{if } x = \sum_{j=1}^n b_j x_j.$$

Then prove that $A: X \rightarrow Y$ is linear.

Exercise 8.1.11: Prove [Proposition 8.1.19](#). Hint: A linear transformation is determined by its action on a basis. So given two bases $\{x_1, \dots, x_n\}$ and $\{y_1, \dots, y_m\}$ for X and Y respectively, consider the linear operators A_{jk} that send $A_{jk}x_j = y_k$, and $A_{jk}x_\ell = 0$ if $\ell \neq j$.

Exercise 8.1.12 (Easy): Suppose X and Y are vector spaces and $A \in L(X, Y)$ is a linear operator.

- Show that the nullspace $N := \{x \in X : Ax = 0\}$ is a vector space.
- Show that the range $R := \{y \in Y : Ax = y \text{ for some } x \in X\}$ is a vector space.

Exercise 8.1.13 (Easy): Show by example that a union of convex sets need not be convex.

Exercise 8.1.14: Compute the convex hull of the set of 3 points $\{(0, 0), (0, 1), (1, 1)\}$ in \mathbb{R}^2 .

Exercise 8.1.15: Show that the set $\{(x, y) \in \mathbb{R}^2 : y > x^2\}$ is a convex set.

Exercise 8.1.16: Show that the set $X \subset C([0, 1], \mathbb{R})$ of those functions such that $\int_0^1 f = 1$ is a convex set, but not a vector subspace.

Exercise 8.1.17: Show that every convex set in \mathbb{R}^n is connected using the standard topology on \mathbb{R}^n .

Exercise 8.1.18: Suppose $K \subset \mathbb{R}^2$ is a convex set such that the only point of the form $(x, 0)$ in K is the point $(0, 0)$. Further suppose that $(0, 1) \in K$ and $(1, 1) \in K$. Then show that if $(x, y) \in K$, then $y > 0$ unless $x = 0$.

Exercise 8.1.19: Prove that an arbitrary intersection of vector subspaces is a vector subspace. That is, if X is a vector space and $\{V_\lambda\}_{\lambda \in I}$ is an arbitrary collection of vector subspaces of X , then $\bigcap_{\lambda \in I} V_\lambda$ is a vector subspace of X .

8.2 Analysis with vector spaces

Note: 3 lectures

8.2.1 Norms

Let us start measuring the size of vectors and hence distance.

Definition 8.2.1. If X is a vector space, then we say a function $\|\cdot\|: X \rightarrow \mathbb{R}$ is a *norm* if

- (i) $\|x\| \geq 0$, with $\|x\| = 0$ if and only if $x = 0$.
- (ii) $\|cx\| = |c| \|x\|$ for all $c \in \mathbb{R}$ and $x \in X$.
- (iii) $\|x + y\| \leq \|x\| + \|y\|$ for all $x, y \in X$. (*triangle inequality*)

A vector space equipped with a norm is called a *normed vector space*.

Given a norm (any norm) on a vector space X , we define a distance $d(x, y) := \|x - y\|$, and this d makes X into a metric space (exercise). So everything you know about metric spaces applies to normed vector spaces.

Before defining the standard norm on \mathbb{R}^n , let us define the standard scalar *dot product* on \mathbb{R}^n . For two vectors if $x = (x_1, x_2, \dots, x_n) \in \mathbb{R}^n$ and $y = (y_1, y_2, \dots, y_n) \in \mathbb{R}^n$, define

$$x \cdot y := \sum_{j=1}^n x_j y_j.$$

The dot product is linear in each variable separately, or in more fancy language it is *bilinear*. That is, if y is fixed, the map $x \mapsto x \cdot y$ is a linear map from \mathbb{R}^n to \mathbb{R} . Similarly, if x is fixed, then $y \mapsto x \cdot y$ is linear. It is also symmetric in the sense that $x \cdot y = y \cdot x$. The *euclidean norm* is defined as

$$\|x\| := \|x\|_{\mathbb{R}^n} := \sqrt{x \cdot x} = \sqrt{(x_1)^2 + (x_2)^2 + \dots + (x_n)^2}.$$

We normally just use $\|x\|$, only in the rare instance when it is necessary to emphasize that we are talking about the euclidean norm will we use $\|x\|_{\mathbb{R}^n}$. It is easy to see that the euclidean norm satisfies (i) and (ii). To prove that (iii) holds, the key inequality is the so-called Cauchy–Schwarz inequality we saw before. As this inequality is so important, we restate and reprove a slightly stronger version using the notation of this chapter.

Theorem 8.2.2 (Cauchy–Schwarz inequality). *Let $x, y \in \mathbb{R}^n$, then*

$$|x \cdot y| \leq \|x\| \|y\| = \sqrt{x \cdot x} \sqrt{y \cdot y},$$

with equality if and only if $x = \lambda y$ or $y = \lambda x$ for some $\lambda \in \mathbb{R}$.

Proof. If $x = 0$ or $y = 0$, then the theorem holds trivially. So assume $x \neq 0$ and $y \neq 0$.

If x is a scalar multiple of y , that is $x = \lambda y$ for some $\lambda \in \mathbb{R}$, then the theorem holds with equality:

$$|x \cdot y| = |\lambda y \cdot y| = |\lambda| |y \cdot y| = |\lambda| \|y\|^2 = \|\lambda y\| \|y\| = \|x\| \|y\|.$$

Fixing x and y , as a function of t , $\|x + ty\|^2$ is a quadratic polynomial:

$$\|x + ty\|^2 = (x + ty) \cdot (x + ty) = x \cdot x + x \cdot ty + ty \cdot x + ty \cdot ty = \|x\|^2 + 2t(x \cdot y) + t^2\|y\|^2.$$

If x is not a scalar multiple of y , then $\|x + ty\|^2 > 0$ for all t . So the polynomial $\|x + ty\|^2$ is never zero. Elementary algebra says that the discriminant must be negative:

$$4(x \cdot y)^2 - 4\|x\|^2\|y\|^2 < 0,$$

or in other words, $(x \cdot y)^2 < \|x\|^2\|y\|^2$. □

Item (iii), the triangle inequality in \mathbb{R}^n , follows from:

$$\|x + y\|^2 = x \cdot x + y \cdot y + 2(x \cdot y) \leq \|x\|^2 + \|y\|^2 + 2(\|x\| \|y\|) = (\|x\| + \|y\|)^2.$$

The distance $d(x, y) := \|x - y\|$ is the standard distance (standard metric) on \mathbb{R}^n that we used when we talked about metric spaces.

Definition 8.2.3. Let $A \in L(X, Y)$. Define

$$\|A\| := \sup\{\|Ax\| : x \in X \text{ with } \|x\| = 1\}.$$

The number $\|A\|$ (possibly ∞) is called the *operator norm*. We will see below that it is indeed a norm for finite-dimensional spaces. Again, when necessary to emphasize which norm we are talking about, we may write it as $\|A\|_{L(X, Y)}$.

By linearity, $\left\|A \frac{x}{\|x\|}\right\| = \frac{\|Ax\|}{\|x\|}$ for all nonzero $x \in X$. The vector $\frac{x}{\|x\|}$ is of norm 1. Therefore,

$$\|A\| = \sup\{\|Ax\| : x \in X \text{ with } \|x\| = 1\} = \sup_{\substack{x \in X \\ x \neq 0}} \frac{\|Ax\|}{\|x\|}.$$

This implies that, assuming $\|A\|$ is not infinity,

$$\|Ax\| \leq \|A\|\|x\|.$$

It is not hard to see from the definition that $\|A\| = 0$ if and only if $A = 0$, that is, if A takes every vector to the zero vector.

It is also not difficult to compute the operator norm of the identity operator:

$$\|I\| = \sup_{\substack{x \in X \\ x \neq 0}} \frac{\|Ix\|}{\|x\|} = \sup_{\substack{x \in X \\ x \neq 0}} \frac{\|x\|}{\|x\|} = 1.$$

The operator norm is not always a norm on $L(X, Y)$, in particular, $\|A\|$ is not always finite for $A \in L(X, Y)$. We prove below that $\|A\|$ is finite when X is finite-dimensional. The operator norm being finite is equivalent to A being continuous. For infinite-dimensional spaces, neither statement needs to be true. For an example, consider the vector space of continuously differentiable functions on $[0, 2\pi]$ using the uniform norm. The functions $t \mapsto \sin(nt)$ have norm 1, but their derivatives

have norm n . So differentiation, which is a linear operator, has infinite operator norm on this space. We will stick to finite-dimensional spaces.

When we talk about a finite-dimensional vector space X , we often think of \mathbb{R}^n , although if we have a norm on X , the norm might not be the standard euclidean norm. In the exercises, you can prove that every norm is “equivalent” to the euclidean norm in that the topology it generates is the same. For simplicity, we only prove the following proposition for the euclidean space, and the proof for a general finite-dimensional space is left as an exercise.

Proposition 8.2.4. *Let X and Y be normed vector spaces. Suppose that X is finite-dimensional. If $A \in L(X, Y)$, then $\|A\| < \infty$, and A is uniformly continuous (Lipschitz with constant $\|A\|$).*

Proof. As we said we only prove the proposition for euclidean space, so suppose that $X = \mathbb{R}^n$ and the norm is the standard euclidean norm. The general case is left as an exercise.

Let $\{e_1, e_2, \dots, e_n\}$ be the standard basis of \mathbb{R}^n . Write $x \in \mathbb{R}^n$, with $\|x\| = 1$, as

$$x = \sum_{j=1}^n c_j e_j.$$

Since $e_j \cdot e_\ell = 0$ whenever $j \neq \ell$ and $e_j \cdot e_j = 1$, then $c_j = x \cdot e_j$ and by Cauchy–Schwarz

$$|c_j| = |x \cdot e_j| \leq \|x\| \|e_j\| = 1.$$

Then

$$\|Ax\| = \left\| \sum_{j=1}^n c_j A e_j \right\| \leq \sum_{j=1}^n |c_j| \|A e_j\| \leq \sum_{j=1}^n \|A e_j\|.$$

The right-hand side does not depend on x . We found a finite upper bound independent of x , so $\|A\| < \infty$.

For any normed vector spaces X and Y , and $A \in L(X, Y)$, suppose that $\|A\| < \infty$. For $v, w \in X$,

$$\|Av - Aw\| = \|A(v - w)\| \leq \|A\| \|v - w\|.$$

As $\|A\| < \infty$, then this says A is Lipschitz with constant $\|A\|$. □

Proposition 8.2.5. *Let X , Y , and Z be finite-dimensional normed vector spaces*.*

(i) *If $A, B \in L(X, Y)$ and $c \in \mathbb{R}$, then*

$$\|A + B\| \leq \|A\| + \|B\|, \quad \|cA\| = |c| \|A\|.$$

In particular, the operator norm is a norm on the vector space $L(X, Y)$.

(ii) *If $A \in L(X, Y)$ and $B \in L(Y, Z)$, then*

$$\|BA\| \leq \|B\| \|A\|.$$

*If we strike the “In particular” part and interpret the algebra with infinite operator norms properly, namely decree that 0 times ∞ is 0 , then this result also holds for infinite-dimensional spaces.

Proof. First, since all the spaces are finite-dimensional, then all the operator norms are finite, and the statements make sense to begin with.

For (i),

$$\|(A+B)x\| = \|Ax+Bx\| \leq \|Ax\| + \|Bx\| \leq \|A\| \|x\| + \|B\| \|x\| = (\|A\| + \|B\|) \|x\|.$$

So $\|A+B\| \leq \|A\| + \|B\|$.

Similarly,

$$\|(cA)x\| = |c| \|Ax\| \leq (|c| \|A\|) \|x\|.$$

Thus $\|cA\| \leq |c| \|A\|$. Next,

$$|c| \|Ax\| = \|cAx\| \leq \|cA\| \|x\|.$$

Hence $|c| \|A\| \leq \|cA\|$.

For (ii) write

$$\|BAx\| \leq \|B\| \|Ax\| \leq \|B\| \|A\| \|x\|. \quad \square$$

As a norm defines a metric, there is a metric space topology on $L(X, Y)$ for finite-dimensional vector spaces, so we can talk about open/closed sets, continuity, and convergence.

Proposition 8.2.6. *Let X be a finite-dimensional normed vector space. Let $GL(X) \subset L(X)$ be the set of invertible linear operators.*

(i) *If $A \in GL(X)$, $B \in L(X)$, and*

$$\|A - B\| < \frac{1}{\|A^{-1}\|}, \quad (8.2)$$

then B is invertible.

(ii) *$GL(X)$ is an open subset, and $A \mapsto A^{-1}$ is a continuous function on $GL(X)$.*

Let us make sense of this proposition on a simple example. Consider $X = \mathbb{R}^1$, where linear operators are just numbers a and the operator norm of a is $|a|$. The operator a is invertible ($a^{-1} = 1/a$) whenever $a \neq 0$. The condition $|a - b| < \frac{1}{|a^{-1}|}$ does indeed imply that b is not zero. And $a \mapsto 1/a$ is a continuous map. When $n > 1$, then there are other noninvertible operators than just zero, and in general things are a bit more difficult.

Proof. Let us prove (i). We know something about A^{-1} and $A - B$. These are linear operators so let us apply them to a vector:

$$A^{-1}(A - B)x = x - A^{-1}Bx.$$

Therefore,

$$\begin{aligned} \|x\| &= \|A^{-1}(A - B)x + A^{-1}Bx\| \\ &\leq \|A^{-1}\| \|A - B\| \|x\| + \|A^{-1}\| \|Bx\|. \end{aligned}$$

Now assume $x \neq 0$ and so $\|x\| \neq 0$. Using (8.2) we obtain

$$\|x\| < \|x\| + \|A^{-1}\| \|Bx\|,$$

or in other words $\|Bx\| \neq 0$ for all nonzero x , and hence $Bx \neq 0$ for all nonzero x . This is enough to see that B is one-to-one (if $Bx = By$, then $B(x - y) = 0$, so $x = y$). As B is one-to-one operator from X to X , which is finite-dimensional, B is invertible.

Let us prove (ii). Fix some $A \in GL(X)$. Let B be near A , specifically $\|A - B\| < \frac{1}{2\|A^{-1}\|}$. Then (8.2) is satisfied and B is invertible. We have shown above (using $B^{-1}y$ instead of x)

$$\|B^{-1}y\| \leq \|A^{-1}\| \|A - B\| \|B^{-1}y\| + \|A^{-1}\| \|y\| \leq \frac{1}{2} \|B^{-1}y\| + \|A^{-1}\| \|y\|,$$

or

$$\|B^{-1}y\| \leq 2\|A^{-1}\| \|y\|.$$

So $\|B^{-1}\| \leq 2\|A^{-1}\|$.

Now

$$A^{-1}(A - B)B^{-1} = A^{-1}(AB^{-1} - I) = B^{-1} - A^{-1},$$

and

$$\|B^{-1} - A^{-1}\| = \|A^{-1}(A - B)B^{-1}\| \leq \|A^{-1}\| \|A - B\| \|B^{-1}\| \leq 2\|A^{-1}\|^2 \|A - B\|.$$

Therefore, as B tends to A , $\|B^{-1} - A^{-1}\|$ tends to 0, and so the inverse operation is a continuous function at A . \square

8.2.2 Matrices

Once we fix a basis in a finite-dimensional vector space X , we can represent a vector of X as an n -tuple of numbers, that is a vector in \mathbb{R}^n . The same thing can be done with $L(X, Y)$, which brings us to matrices, which are a convenient way to represent finite-dimensional linear transformations. Suppose $\{x_1, x_2, \dots, x_n\}$ and $\{y_1, y_2, \dots, y_m\}$ are bases for vector spaces X and Y respectively. A linear operator is determined by its values on the basis. Given $A \in L(X, Y)$, Ax_j is an element of Y . Define the numbers $a_{i,j}$ as follows

$$Ax_j = \sum_{i=1}^m a_{i,j} y_i, \quad (8.3)$$

and write them as a *matrix*

$$A = \begin{bmatrix} a_{1,1} & a_{1,2} & \cdots & a_{1,n} \\ a_{2,1} & a_{2,2} & \cdots & a_{2,n} \\ \vdots & \vdots & \ddots & \vdots \\ a_{m,1} & a_{m,2} & \cdots & a_{m,n} \end{bmatrix}.$$

We sometimes write A as $[a_{i,j}]$. We say A is an m -by- n matrix. The *columns* of the matrix are precisely the coefficients that represent Ax_j in terms of the basis $\{y_1, y_2, \dots, y_m\}$. If we know the numbers $a_{i,j}$, then via the formula (8.3) we find the corresponding linear operator, as it is determined by the action on a basis. Hence, once we fix a basis on X and on Y , we have a one-to-one correspondence between $L(X, Y)$ and the m -by- n matrices.

When

$$z = \sum_{j=1}^n c_j x_j,$$

then

$$Az = \sum_{j=1}^n c_j Ax_j = \sum_{j=1}^n c_j \left(\sum_{i=1}^m a_{i,j} y_i \right) = \sum_{i=1}^m \left(\sum_{j=1}^n a_{i,j} c_j \right) y_i,$$

which gives rise to the familiar rule for matrix multiplication.

There is a one-to-one correspondence between matrices and linear operators in $L(X, Y)$, once we fix a basis in X and in Y . If we choose a different basis, we get different matrices. This is an important distinction, the operator A acts on elements of X , the matrix is something that works with n -tuples of numbers, that is, vectors of \mathbb{R}^n .

If B is an n -by- r matrix with entries $b_{j,k}$, then the matrix for $C = AB$ is an m -by- r matrix whose (i, k) th entry $c_{i,k}$ is

$$c_{i,k} = \sum_{j=1}^n a_{i,j} b_{j,k}.$$

A way to remember it is if you order the indices as we do, that is *row*, *column*, and put the elements in the same order as the matrices, then it is the “middle index” that is “summed-out.”

A linear mapping changing one basis to another is represented by a square matrix in which the columns represent vectors of the second basis in terms of the first basis. We call such a linear mapping a *change of basis*. So for two choices of a basis in an n -dimensional vector space, there is a linear mapping (a change of basis) taking one basis to the other, and this corresponds to an n -by- n matrix which does the corresponding operation on \mathbb{R}^n .

Suppose $X = \mathbb{R}^n$, $Y = \mathbb{R}^m$, and all the bases are just the standard bases. Using the Cauchy–Schwarz inequality compute

$$\|Az\|^2 = \sum_{i=1}^m \left(\sum_{j=1}^n a_{i,j} c_j \right)^2 \leq \sum_{i=1}^m \left(\sum_{j=1}^n (c_j)^2 \right) \left(\sum_{j=1}^n (a_{i,j})^2 \right) = \sum_{i=1}^m \left(\sum_{j=1}^n (a_{i,j})^2 \right) \|z\|^2.$$

In other words, we have a bound on the operator norm (note that equality rarely happens)

$$\|A\| \leq \sqrt{\sum_{i=1}^m \sum_{j=1}^n (a_{i,j})^2}.$$

If the entries go to zero, then $\|A\|$ goes to zero. In particular, if A is fixed and B is changing such that the entries of $A - B$ go to zero, then B goes to A in operator norm. That is, B goes to A in the metric space topology induced by the operator norm. We proved the first part of:

Proposition 8.2.7. *If $f: S \rightarrow \mathbb{R}^m$ is a continuous function for a metric space S , then considering the components of f as the entries of a matrix, f is a continuous mapping from S to $L(\mathbb{R}^n, \mathbb{R}^m)$. Conversely, if $f: S \rightarrow L(\mathbb{R}^n, \mathbb{R}^m)$ is a continuous function, then the entries of the corresponding matrix are continuous functions.*

Let us prove the second part. Take $f(x)e_j$, which is a continuous function of S to \mathbb{R}^m with standard euclidean norm: $\|f(x)e_j - f(y)e_j\| = \|(f(x) - f(y))e_j\| \leq \|f(x) - f(y)\|$, so as $x \rightarrow y$, then $\|f(x) - f(y)\| \rightarrow 0$ and so $\|f(x)e_j - f(y)e_j\| \rightarrow 0$. Such a function is continuous if and only if its components are continuous, and these are the entries of the j th column of the matrix $f(x)$.

8.2.3 Determinants

A certain number can be assigned to square matrices that measures how the corresponding linear mapping stretches space. In particular, this number, called the determinant, can be used to test for invertibility of a matrix.

Define the symbol $\text{sgn}(x)$ (read “sign of x ”) for a number x by

$$\text{sgn}(x) := \begin{cases} -1 & \text{if } x < 0, \\ 0 & \text{if } x = 0, \\ 1 & \text{if } x > 0. \end{cases}$$

Suppose $\sigma = (\sigma_1, \sigma_2, \dots, \sigma_n)$ is a *permutation* of the integers $(1, 2, \dots, n)$, that is, a reordering of $(1, 2, \dots, n)$. Let

$$\text{sgn}(\sigma) = \text{sgn}(\sigma_1, \dots, \sigma_n) := \prod_{p < q} \text{sgn}(\sigma_q - \sigma_p). \quad (8.4)$$

Here \prod stands for multiplication, similarly to how \sum stands for summation.

Any permutation can be obtained by a sequence of transpositions (switchings of two elements). We say a permutation is a permutation *even* (resp. *odd*) if it takes an even (resp. odd) number of transpositions to get from $(1, 2, \dots, n)$ to σ . For example, $(2, 4, 3, 1)$ is two transpositions away from $(1, 2, 3, 4)$ and is therefore even: $(1, 2, 3, 4) \rightarrow (2, 1, 3, 4) \rightarrow (2, 4, 3, 1)$. Being even or odd is well-defined: $\text{sgn}(\sigma)$ is 1 if σ is even and -1 if σ is odd (exercise). This fact can be proved by noting that applying a transposition changes the sign, and computing that $\text{sgn}(1, 2, \dots, n) = 1$.

Let S_n be the set of all permutations on n elements (the *symmetric group*). Let $A = [a_{i,j}]$ be a square n -by- n matrix. Define the *determinant* of A

$$\det(A) := \sum_{\sigma \in S_n} \text{sgn}(\sigma) \prod_{i=1}^n a_{i, \sigma_i}.$$

Proposition 8.2.8.

- (i) $\det(I) = 1$.
- (ii) For every $j = 1, 2, \dots, n$, the function $x_j \mapsto \det([x_1 \ x_2 \ \cdots \ x_n])$ is linear.
- (iii) If two columns of a matrix are interchanged, then the determinant changes sign.
- (iv) If two columns of A are equal, then $\det(A) = 0$.
- (v) If a column is zero, then $\det(A) = 0$.
- (vi) $A \mapsto \det(A)$ is a continuous function on $L(\mathbb{R}^n)$.
- (vii) $\det\left(\begin{bmatrix} a & b \\ c & d \end{bmatrix}\right) = ad - bc$, and $\det([a]) = a$.

In fact, the determinant is the unique function that satisfies (i), (ii), and (iii). But we digress. By (ii), we mean that if we fix all the vectors x_1, \dots, x_n except for x_j , and let $v, w \in \mathbb{R}^n$ be two vectors, and $a, b \in \mathbb{R}$ be scalars, then

$$\det\left(\begin{bmatrix} x_1 & \cdots & x_{j-1} & (av + bw) & x_{j+1} & \cdots & x_n \end{bmatrix}\right) = a \det\left(\begin{bmatrix} x_1 & \cdots & x_{j-1} & v & x_{j+1} & \cdots & x_n \end{bmatrix}\right) + b \det\left(\begin{bmatrix} x_1 & \cdots & x_{j-1} & w & x_{j+1} & \cdots & x_n \end{bmatrix}\right).$$

Proof. We go through the proof quickly, as you have likely seen this before.

Item (i) is trivial. For (ii), notice that each term in the definition of the determinant contains exactly one factor from each column.

Item (iii) follows by noting that switching two columns is like switching the two corresponding numbers in every element in S_n . Hence, all the signs are changed. Item (iv) follows because if two columns are equal, and we switch them, we get the same matrix back. So item (iii) says the determinant must be 0.

Item (v) follows because the product in each term in the definition includes one element from the zero column. Item (vi) follows as \det is a polynomial in the entries of the matrix and hence continuous (in the entries of the matrix). A function defined on matrices is continuous in the operator norm if and only if it is continuous in the entries. Finally, item (vii) is a direct computation. \square

The determinant tells us about areas and volumes, and how they change. For example, in the 1-by-1 case, a matrix is just a number, and the determinant is exactly this number. It says how the linear mapping “stretches” the space. Similarly for \mathbb{R}^2 . Suppose $A \in L(\mathbb{R}^2)$ is a linear transformation. It can be checked directly that the area of the image of the unit square $A([0, 1]^2)$ is precisely $|\det(A)|$. This works with arbitrary figures, not just the unit square: The absolute value of the determinant tells us the stretch in the area. The sign of the determinant tells us if the image is flipped (changes orientation) or not. In \mathbb{R}^3 it tells us about the 3-dimensional volume, and in n dimensions about the n -dimensional volume. We claim this without proof.

Proposition 8.2.9. *If A and B are n -by- n matrices, then $\det(AB) = \det(A)\det(B)$. Furthermore, A is invertible if and only if $\det(A) \neq 0$ and in this case, $\det(A^{-1}) = \frac{1}{\det(A)}$.*

Proof. Let b_1, b_2, \dots, b_n be the columns of B . Then

$$AB = [Ab_1 \quad Ab_2 \quad \cdots \quad Ab_n].$$

That is, the columns of AB are Ab_1, Ab_2, \dots, Ab_n .

Let $b_{j,k}$ denote the elements of B and a_j the columns of A . By linearity of the determinant,

$$\begin{aligned} \det(AB) &= \det([Ab_1 \quad Ab_2 \quad \cdots \quad Ab_n]) = \det\left(\left[\sum_{j=1}^n b_{j,1}a_j \quad Ab_2 \quad \cdots \quad Ab_n\right]\right) \\ &= \sum_{j=1}^n b_{j,1} \det([a_j \quad Ab_2 \quad \cdots \quad Ab_n]) \\ &= \sum_{1 \leq j_1, j_2, \dots, j_n \leq n} b_{j_1,1} b_{j_2,2} \cdots b_{j_n,n} \det([a_{j_1} \quad a_{j_2} \quad \cdots \quad a_{j_n}]) \\ &= \left(\sum_{(j_1, j_2, \dots, j_n) \in S_n} b_{j_1,1} b_{j_2,2} \cdots b_{j_n,n} \operatorname{sgn}(j_1, j_2, \dots, j_n) \right) \det([a_1 \quad a_2 \quad \cdots \quad a_n]). \end{aligned}$$

In the last equality, we can sum over just the elements of S_n instead of all n -tuples for integers between 1 and n by noting that when two columns in the determinant are the same, then the determinant is zero. Then we reordered the columns to the original ordering to obtain the sgn .

The conclusion that $\det(AB) = \det(A)\det(B)$ follows by recognizing above the determinant of B . We obtain this by plugging in $A = I$. The expression we got for the determinant of B has rows

and columns swapped, so as a side note, we have also just proved that the determinant of a matrix and its transpose are equal.

To prove the second part of the theorem, suppose A is invertible. Then $A^{-1}A = I$ and consequently $\det(A^{-1})\det(A) = \det(A^{-1}A) = \det(I) = 1$. If A is not invertible, then there must be a nonzero vector that A takes to zero as A is not one-to-one. In other words, the columns of A are linearly dependent. Suppose

$$\sum_{j=1}^n \gamma_j a_j = 0,$$

where not all γ_j are equal to 0. Without loss of generality suppose $\gamma_1 \neq 0$. Take

$$B := \begin{bmatrix} \gamma_1 & 0 & 0 & \cdots & 0 \\ \gamma_2 & 1 & 0 & \cdots & 0 \\ \gamma_3 & 0 & 1 & \cdots & 0 \\ \vdots & \vdots & \vdots & \ddots & \vdots \\ \gamma_n & 0 & 0 & \cdots & 1 \end{bmatrix}.$$

Using the definition of the determinant (there is only a single permutation σ for which $\prod_{i=1}^n b_{i,\sigma_i}$ is nonzero) we find $\det(B) = \gamma_1 \neq 0$. Then $\det(AB) = \det(A)\det(B) = \gamma_1 \det(A)$. The first column of AB is zero, and hence $\det(AB) = 0$. We conclude $\det(A) = 0$. \square

Proposition 8.2.10. *Determinant is independent of the basis. In other words, if B is invertible, then*

$$\det(A) = \det(B^{-1}AB).$$

The proof is to compute $\det(B^{-1}AB) = \det(B^{-1})\det(A)\det(B) = \frac{1}{\det(B)}\det(A)\det(B) = \det(A)$.

If in one basis A is the matrix representing a linear operator, then for another basis we can find a matrix B such that the matrix $B^{-1}AB$ takes us to the first basis, applies A in the first basis, and takes us back to the basis we started with. Let X be a finite-dimensional vector space. Let $\Phi \in L(X, \mathbb{R}^n)$ take a basis $\{x_1, \dots, x_n\}$ to the standard basis $\{e_1, \dots, e_n\}$ and let $\Psi \in L(X, \mathbb{R}^n)$ take another basis $\{y_1, \dots, y_n\}$ to the standard basis. Let $T \in L(X)$ be a linear operator and let a matrix A represent the operator in the basis $\{x_1, \dots, x_n\}$. Then B would be such that we have the following diagram*:

$$\begin{array}{ccc} \mathbb{R}^n & \xrightarrow{B^{-1}AB} & \mathbb{R}^n \\ \uparrow \Psi & & \Psi^{-1} \downarrow \\ X & \xrightarrow{T} & X \\ \downarrow \Phi & & \Phi^{-1} \uparrow \\ \mathbb{R}^n & \xrightarrow{A} & \mathbb{R}^n \end{array} \quad \begin{array}{l} \left. \begin{array}{c} \uparrow \\ \downarrow \end{array} \right\} B \\ \left. \begin{array}{c} \uparrow \\ \downarrow \end{array} \right\} B^{-1} \end{array}$$

The two \mathbb{R}^n 's on the bottom row represent X in the first basis, and the \mathbb{R}^n 's on top represent X in the second basis.

If we compute the determinant of the matrix A , we obtain the same determinant if we use any other basis; In the other basis the matrix would be $B^{-1}AB$. Consequently,

$$\det: L(X) \rightarrow \mathbb{R}$$

*This is a so-called *commutative diagram*. Following arrows in any way should end up with the same result.

is a well-defined function (not just on matrices).

There are three types of so-called *elementary matrices*. Let e_1, e_2, \dots, e_n be the standard basis on \mathbb{R}^n as usual.

First, for $j = 1, 2, \dots, n$ and $\lambda \in \mathbb{R}$, $\lambda \neq 0$, define the first type of an elementary matrix, an n -by- n matrix E by

$$Ee_i := \begin{cases} e_i & \text{if } i \neq j, \\ \lambda e_i & \text{if } i = j. \end{cases}$$

Given any n -by- m matrix M the matrix EM is the same matrix as M except with the k th row multiplied by λ . It is an easy computation (exercise) that $\det(E) = \lambda$.

Next, for j and k with $j \neq k$, and $\lambda \in \mathbb{R}$, define the second type of an elementary matrix E by

$$Ee_i := \begin{cases} e_i & \text{if } i \neq j, \\ e_i + \lambda e_k & \text{if } i = j. \end{cases}$$

Given any n -by- m matrix M the matrix EM is the same matrix as M except with λ times the k th row added to the j th row. It is an easy computation (exercise) that $\det(E) = 1$.

Finally, for j and k with $j \neq k$, define the third type of an elementary matrix E by

$$Ee_i := \begin{cases} e_i & \text{if } i \neq j \text{ and } i \neq k, \\ e_k & \text{if } i = j, \\ e_j & \text{if } i = k. \end{cases}$$

Given any n -by- m matrix M the matrix EM is the same matrix with j th and k th rows swapped. It is an easy computation (exercise) that $\det(E) = -1$.

Proposition 8.2.11. *Let T be an n -by- n invertible matrix. Then there exists a finite sequence of elementary matrices E_1, E_2, \dots, E_k such that*

$$T = E_1 E_2 \cdots E_k,$$

and

$$\det(T) = \det(E_1) \det(E_2) \cdots \det(E_k).$$

The proof is left as an exercise. The proposition says that we can compute the determinant by doing elementary row operations. For computing the determinant, one does not have to factor the matrix into a product of elementary matrices completely. One only does row operations until one finds an *upper triangular matrix*, that is, a matrix $[a_{i,j}]$ where $a_{i,j} = 0$ if $i > j$. Computing determinant of such a matrix is not difficult (exercise).

Factorization into elementary matrices (or variations on elementary matrices) is useful in proofs involving an arbitrary linear operator, by reducing to a proof for an elementary matrix, similarly as the computation of the determinant.

8.2.4 Exercises

Exercise 8.2.1: For a vector space X with a norm $\|\cdot\|$, show that $d(x, y) := \|x - y\|$ makes X a metric space.

Exercise 8.2.2 (Easy): Show that for square matrices A and B , $\det(AB) = \det(BA)$.

Exercise 8.2.3: For \mathbb{R}^n define

$$\|x\|_\infty := \max\{|x_1|, |x_2|, \dots, |x_n|\},$$

sometimes called the sup or the max norm.

a) Show that $\|\cdot\|_\infty$ is a norm on \mathbb{R}^n (defining a different distance).

b) What is the unit ball $B(0, 1)$ in this norm?

Exercise 8.2.4: For \mathbb{R}^n define

$$\|x\|_1 := \sum_{j=1}^n |x_j|,$$

sometimes called the 1-norm (or L^1 norm).

a) Show that $\|\cdot\|_1$ is a norm on \mathbb{R}^n (defining a different distance, sometimes called the taxicab distance).

b) What is the unit ball $B(0, 1)$ in this norm?

Exercise 8.2.5: Using the euclidean norm on \mathbb{R}^2 , compute the operator norm of the operators in $L(\mathbb{R}^2)$ given by the matrices:

a) $\begin{bmatrix} 1 & 0 \\ 0 & 2 \end{bmatrix}$ b) $\begin{bmatrix} 0 & 1 \\ -1 & 0 \end{bmatrix}$ c) $\begin{bmatrix} 1 & 1 \\ 0 & 1 \end{bmatrix}$ d) $\begin{bmatrix} 0 & 1 \\ 0 & 0 \end{bmatrix}$

Exercise 8.2.6: Using the standard euclidean norm \mathbb{R}^n . Show

a) Suppose $A \in L(\mathbb{R}, \mathbb{R}^n)$ is defined for $x \in \mathbb{R}$ by $Ax = xa$ for a vector $a \in \mathbb{R}^n$. Then the operator norm $\|A\|_{L(\mathbb{R}, \mathbb{R}^n)} = \|a\|_{\mathbb{R}^n}$. (That is, the operator norm of A is the euclidean norm of a .)

b) Suppose $B \in L(\mathbb{R}^n, \mathbb{R})$ is defined for $x \in \mathbb{R}^n$ by $Bx = b \cdot x$ for a vector $b \in \mathbb{R}^n$. Then the operator norm $\|B\|_{L(\mathbb{R}^n, \mathbb{R})} = \|b\|_{\mathbb{R}^n}$.

Exercise 8.2.7: Suppose $\sigma = (\sigma_1, \sigma_2, \dots, \sigma_n)$ is a permutation of $(1, 2, \dots, n)$.

a) Show that we can make a finite number of transpositions (switching of two elements) to get to $(1, 2, \dots, n)$.

b) Using the definition (8.4) show that σ is even if $\text{sgn}(\sigma) = 1$ and σ is odd if $\text{sgn}(\sigma) = -1$. In particular, showing that being odd or even is well-defined.

Exercise 8.2.8: Verify the computation of the determinant for the three types of elementary matrices.

Exercise 8.2.9: Prove [Proposition 8.2.11](#).

Exercise 8.2.10:

a) Suppose $D = [d_{i,j}]$ is an n -by- n diagonal matrix, that is, $d_{i,j} = 0$ whenever $i \neq j$. Show that $\det(D) = d_{1,1}d_{2,2} \cdots d_{n,n}$.

b) Suppose A is a diagonalizable matrix. That is, there exists a matrix B such that $B^{-1}AB = D$ for a diagonal matrix $D = [d_{i,j}]$. Show that $\det(A) = d_{1,1}d_{2,2} \cdots d_{n,n}$.

Exercise 8.2.11: Take the vector space of polynomials $\mathbb{R}[t]$ and the linear operator $D \in L(\mathbb{R}[t])$ that is the differentiation (we proved in an earlier exercise that D is a linear operator). Given $P(t) = c_0 + c_1t + \cdots + c_nt^n \in \mathbb{R}[t]$ define $\|P\| := \sup\{|c_j| : j = 0, 1, 2, \dots, n\}$.

- Show that $\|P\|$ is a norm on $\mathbb{R}[t]$.
- Show that D does not have bounded operator norm, that is $\|D\| = \infty$. Hint: Consider the polynomials t^n as n tends to infinity.

Exercise 8.2.12: In this exercise, we finish the proof of [Proposition 8.2.4](#). Let X be a finite-dimensional normed vector space with basis $\{x_1, x_2, \dots, x_n\}$.

- Show that the function $f: \mathbb{R}^n \rightarrow \mathbb{R}$

$$f(c_1, c_2, \dots, c_n) = \|c_1x_1 + c_2x_2 + \cdots + c_nx_n\|$$

is continuous.

- Show that there exist numbers m and M such that if $c = (c_1, c_2, \dots, c_n) \in \mathbb{R}^n$ with $\|c\| = 1$ (standard euclidean norm), then $m \leq \|c_1x_1 + c_2x_2 + \cdots + c_nx_n\| \leq M$ (here the norm is on X).
- Show that there exists a number B such that if $\|c_1x_1 + c_2x_2 + \cdots + c_nx_n\| = 1$, then $|c_j| \leq B$.
- Use part c) to show that if X is finite-dimensional vector spaces and $A \in L(X, Y)$, then $\|A\| < \infty$.

Exercise 8.2.13: Let X be a finite-dimensional vector space with norm $\|\cdot\|$ and basis $\{x_1, x_2, \dots, x_n\}$. Let $c = (c_1, c_2, \dots, c_n) \in \mathbb{R}^n$ and $\|c\|$ be the standard euclidean norm on \mathbb{R}^n .

- Find that there exist positive numbers $m, M > 0$ such that for all $c \in \mathbb{R}^n$

$$m\|c\| \leq \|c_1x_1 + c_2x_2 + \cdots + c_nx_n\| \leq M\|c\|.$$

Hint: See previous exercise.

- Use part a) to show that of $\|\cdot\|_1$ and $\|\cdot\|_2$ are two norms on X , then there exist positive numbers $m, M > 0$ (perhaps different from above) such that for all $x \in X$, we have

$$m\|x\|_1 \leq \|x\|_2 \leq M\|x\|_1.$$

- Show that $U \subset X$ is open in the metric defined by $\|x - y\|_1$ if and only if it is open in the metric defined by $\|x - y\|_2$. In other words, convergence of sequences and continuity of functions is the same in either norm.

Exercise 8.2.14: Let A be an upper triangular matrix. Find a formula for the determinant of A in terms of the diagonal entries, and prove that your formula works.

Exercise 8.2.15: Given an n -by- n matrix A , prove that $|\det(A)| \leq \|A\|^n$ (the norm on A is the operator norm). Hint: Note that you only need to show this for invertible matrices. Then possibly reorder columns and factor A into n matrices, each of which differs from the identity by one column.

Exercise 8.2.16: Consider [Proposition 8.2.6](#) (for all n).

- Prove that the estimate $\|A - B\| < \frac{1}{\|A^{-1}\|}$ is the best possible in the following sense: For every invertible $A \in GL(\mathbb{R}^n)$, find a B where equality is satisfied and B is not invertible.
- For every fixed invertible $A \in GL(\mathbb{R}^n)$, let \mathcal{M} denote the set of matrices B such that $\|A - B\| < \frac{1}{\|A^{-1}\|}$. Prove that while every $B \in \mathcal{M}$ is invertible, $\|B^{-1}\|$ is unbounded as a function of B on \mathcal{M} .

Let A be an n -by- n matrix. A number $\lambda \in \mathbb{C}$ (possibly complex even for a real matrix) is called an *eigenvalue* of A if there is a nonzero (possibly complex) vector $x \in \mathbb{C}^n$ such that $Ax = \lambda x$ (the multiplication by complex vectors is the same as for real vectors. In particular, if $x = a + ib$ for real vectors a and b , and A is a real matrix, then $Ax = Aa + iAb$). The number

$$\rho(A) := \sup\{|\lambda| : \lambda \text{ is an eigenvalue of } A\}$$

is called the *spectral radius* of A . Here $|\lambda|$ is the complex modulus. We state without proof that at least one eigenvalue always exists, and there are no more than n distinct eigenvalues of A . You can therefore assume that $0 \leq \rho(A) < \infty$. The exercises below hold for complex matrices, but feel free to assume they are real matrices.

Exercise 8.2.17: Let A, S be n -by- n matrices, where S is invertible. Prove that λ is an eigenvalue of A , if and only if it is an eigenvalue of $S^{-1}AS$. Then prove that $\rho(S^{-1}AS) = \rho(S)$. In particular, ρ is a well-defined function on $L(X)$ for every finite-dimensional vector space X .

Exercise 8.2.18: Let A be an n -by- n matrix A .

- Prove $\rho(A) \leq \|A\|$.
- For every $k \in \mathbb{N}$, prove $\rho(A) \leq \|A^k\|^{1/k}$.
- Suppose $\lim_{k \rightarrow \infty} A^k = 0$ (limit in the operator norm). Prove that $\rho(A) < 1$.

Exercise 8.2.19: We say a set $C \subset \mathbb{R}^n$ is symmetric if $x \in C$ implies $-x \in C$.

- Let $\|\cdot\|$ be any given norm on \mathbb{R}^n . Show that the closed unit ball $C(0, 1)$ (using the metric induced by this norm) is a compact symmetric convex set.
- (Challenging) Let $C \subset \mathbb{R}^n$ be a compact symmetric convex set and $0 \in C$. Show that

$$\|x\| := \inf\left\{\lambda : \lambda > 0 \text{ and } \frac{x}{\lambda} \in C\right\}$$

is a norm on \mathbb{R}^n , and $C = C(0, 1)$ (the closed unit ball) in the metric induced by this norm.

Hint: Feel free to use the result of [Exercise 8.2.13](#) part c).

8.3 The derivative

Note: 2–3 lectures

8.3.1 The derivative

For a function $f: \mathbb{R} \rightarrow \mathbb{R}$, we defined the derivative at x as

$$\lim_{h \rightarrow 0} \frac{f(x+h) - f(x)}{h}.$$

In other words, there is a number a (the derivative of f at x) such that

$$\lim_{h \rightarrow 0} \left| \frac{f(x+h) - f(x)}{h} - a \right| = \lim_{h \rightarrow 0} \left| \frac{f(x+h) - f(x) - ah}{h} \right| = \lim_{h \rightarrow 0} \frac{|f(x+h) - f(x) - ah|}{|h|} = 0.$$

Multiplying by a is a linear map in one dimension: $h \mapsto ah$. Namely, we think of $a \in L(\mathbb{R}^1, \mathbb{R}^1)$, which is the best linear approximation of how f changes near x . We use this interpretation to extend differentiation to more variables.

Definition 8.3.1. Let $U \subset \mathbb{R}^n$ be open and $f: U \rightarrow \mathbb{R}^m$ a function. We say f is *differentiable* at $x \in U$ if there exists an $A \in L(\mathbb{R}^n, \mathbb{R}^m)$ such that

$$\lim_{\substack{h \rightarrow 0 \\ h \in \mathbb{R}^n}} \frac{\|f(x+h) - f(x) - Ah\|}{\|h\|} = 0.$$

We write $Df(x) := A$, or $f'(x) := A$, and we say A is the *derivative* of f at x . When f is differentiable at every $x \in U$, we say simply that f is *differentiable*. See [Figure 8.3](#) for an illustration.

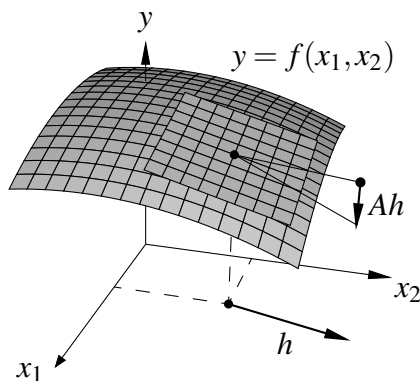

Figure 8.3: Illustration of a derivative for a function $f: \mathbb{R}^2 \rightarrow \mathbb{R}$. The vector h is shown in the x_1x_2 -plane based at (x_1, x_2) , and the vector $Ah \in \mathbb{R}^1$ is shown along the y direction.

For a differentiable function, the derivative of f is a function from U to $L(\mathbb{R}^n, \mathbb{R}^m)$. Compare to the one-dimensional case, where the derivative is a function from U to \mathbb{R} , but we really want

to think of \mathbb{R} here as $L(\mathbb{R}^1, \mathbb{R}^1)$. As in one dimension, the idea is that a differentiable mapping is “infinitesimally close” to a linear mapping, and this linear mapping is the derivative.

Notice which norms are being used in the definition. The norm in the numerator is on \mathbb{R}^m , and the norm in the denominator is on \mathbb{R}^n where h lives. Normally it is understood that $h \in \mathbb{R}^n$ from context (the formula makes no sense otherwise). We will not explicitly say so from now on.

We have again cheated somewhat and said that A is *the* derivative. We have not shown yet that there is only one, let us do that now.

Proposition 8.3.2. *Let $U \subset \mathbb{R}^n$ be an open subset and $f: U \rightarrow \mathbb{R}^m$ a function. Suppose $x \in U$ and there exist $A, B \in L(\mathbb{R}^n, \mathbb{R}^m)$ such that*

$$\lim_{h \rightarrow 0} \frac{\|f(x+h) - f(x) - Ah\|}{\|h\|} = 0 \quad \text{and} \quad \lim_{h \rightarrow 0} \frac{\|f(x+h) - f(x) - Bh\|}{\|h\|} = 0.$$

Then $A = B$.

Proof. Suppose $h \in \mathbb{R}^n$, $h \neq 0$. Compute

$$\begin{aligned} \frac{\|(A-B)h\|}{\|h\|} &= \frac{\|f(x+h) - f(x) - Ah - (f(x+h) - f(x) - Bh)\|}{\|h\|} \\ &\leq \frac{\|f(x+h) - f(x) - Ah\|}{\|h\|} + \frac{\|f(x+h) - f(x) - Bh\|}{\|h\|}. \end{aligned}$$

So $\frac{\|(A-B)h\|}{\|h\|} \rightarrow 0$ as $h \rightarrow 0$. That is, given $\varepsilon > 0$, then for all nonzero h in some δ -ball around the origin

$$\varepsilon > \frac{\|(A-B)h\|}{\|h\|} = \left\| (A-B) \frac{h}{\|h\|} \right\|.$$

For any given x with $\|x\| = 1$, let $h = (\delta/2)x$, then $\|h\| < \delta$ and $\frac{h}{\|h\|} = x$. So $\|(A-B)x\| < \varepsilon$. Taking the supremum over all x with $\|x\| = 1$, we get the operator norm $\|A-B\| \leq \varepsilon$. As $\varepsilon > 0$ was arbitrary, $\|A-B\| = 0$, or in other words $A = B$. \square

Example 8.3.3: If $f(x) = Ax$ for a linear mapping A , then $f'(x) = A$:

$$\frac{\|f(x+h) - f(x) - Ah\|}{\|h\|} = \frac{\|A(x+h) - Ax - Ah\|}{\|h\|} = \frac{0}{\|h\|} = 0.$$

Example 8.3.4: Let $f: \mathbb{R}^2 \rightarrow \mathbb{R}^2$ be defined by

$$f(x, y) = (f_1(x, y), f_2(x, y)) := (1 + x + 2y + x^2, 2x + 3y + xy).$$

Let us show that f is differentiable at the origin and let us compute the derivative, directly using the definition. If the derivative exists, it is in $L(\mathbb{R}^2, \mathbb{R}^2)$, so it can be represented by a 2-by-2 matrix $\begin{bmatrix} a & b \\ c & d \end{bmatrix}$. Suppose $h = (h_1, h_2)$. We need the following expression to go to zero.

$$\begin{aligned} \frac{\|f(h_1, h_2) - f(0, 0) - (ah_1 + bh_2, ch_1 + dh_2)\|}{\|(h_1, h_2)\|} &= \\ &= \frac{\sqrt{((1-a)h_1 + (2-b)h_2 + h_1^2)^2 + ((2-c)h_1 + (3-d)h_2 + h_1h_2)^2}}{\sqrt{h_1^2 + h_2^2}}. \end{aligned}$$

If we choose $a = 1$, $b = 2$, $c = 2$, $d = 3$, the expression becomes

$$\frac{\sqrt{h_1^4 + h_1^2 h_2^2}}{\sqrt{h_1^2 + h_2^2}} = |h_1| \frac{\sqrt{h_1^2 + h_2^2}}{\sqrt{h_1^2 + h_2^2}} = |h_1|.$$

This expression does indeed go to zero as $h \rightarrow 0$. The function f is differentiable at the origin and the derivative $f'(0)$ is represented by the matrix $\begin{bmatrix} 1 & 2 \\ 2 & 3 \end{bmatrix}$.

Proposition 8.3.5. *Let $U \subset \mathbb{R}^n$ be open and $f: U \rightarrow \mathbb{R}^m$ be differentiable at $p \in U$. Then f is continuous at p .*

Proof. Another way to write the differentiability of f at p is to first write

$$r(h) := f(p+h) - f(p) - f'(p)h,$$

and $\frac{\|r(h)\|}{\|h\|}$ must go to zero as $h \rightarrow 0$. So $r(h)$ itself must go to zero. The mapping $h \mapsto f'(p)h$ is a linear mapping between finite-dimensional spaces, it is therefore continuous and goes to zero as $h \rightarrow 0$. Therefore, $f(p+h)$ must go to $f(p)$ as $h \rightarrow 0$. That is, f is continuous at p . \square

The derivative is itself a linear operator on the space of differentiable functions.

Proposition 8.3.6. *Suppose $U \subset \mathbb{R}^n$ is open, $f: U \rightarrow \mathbb{R}^m$ and $g: U \rightarrow \mathbb{R}^m$ are differentiable at p , and $\alpha \in \mathbb{R}$. Then the functions $f+g$ and αf are differentiable at p and*

$$(f+g)'(p) = f'(p) + g'(p), \quad \text{and} \quad (\alpha f)'(p) = \alpha f'(p).$$

Proof. Let $h \in \mathbb{R}^n$, $h \neq 0$. Then

$$\begin{aligned} & \frac{\|f(p+h) + g(p+h) - (f(p) + g(p)) - (f'(p) + g'(p))h\|}{\|h\|} \\ & \leq \frac{\|f(p+h) - f(p) - f'(p)h\|}{\|h\|} + \frac{\|g(p+h) - g(p) - g'(p)h\|}{\|h\|}, \end{aligned}$$

and

$$\frac{\|\alpha f(p+h) - \alpha f(p) - \alpha f'(p)h\|}{\|h\|} = |\alpha| \frac{\|f(p+h) - f(p) - f'(p)h\|}{\|h\|}.$$

The limits as h goes to zero of the right-hand sides are zero by hypothesis. The conclusion follows. \square

If $A \in L(X, Y)$ and $B \in L(Y, Z)$ are linear maps, then they are their own derivative. The composition $BA \in L(X, Z)$ is also its own derivative, and so the derivative of the composition is the composition of the derivatives. As differentiable maps are “infinitesimally close” to linear maps, they have the same property:

Theorem 8.3.7 (Chain rule). *Let $U \subset \mathbb{R}^n$ be open and let $f: U \rightarrow \mathbb{R}^m$ be differentiable at $p \in U$. Let $V \subset \mathbb{R}^m$ be open, $f(U) \subset V$ and let $g: V \rightarrow \mathbb{R}^\ell$ be differentiable at $f(p)$. Then*

$$F(x) = g(f(x))$$

is differentiable at p and

$$F'(p) = g'(f(p))f'(p).$$

Without the points where things are evaluated, this is sometimes written as $F' = (g \circ f)' = g'f'$. The way to understand it is that the derivative of the composition $g \circ f$ is the composition of the derivatives of g and f . If $f'(p) = A$ and $g'(f(p)) = B$, then $F'(p) = BA$, just as for linear maps.

Proof. Let $A := f'(p)$ and $B := g'(f(p))$. Take $h \in \mathbb{R}^n$ and write $q = f(p)$, $k = f(p+h) - f(p)$. Let

$$r(h) := f(p+h) - f(p) - Ah.$$

Then $r(h) = k - Ah$ or $Ah = k - r(h)$, and $f(p+h) = q + k$. We look at the quantity we need to go to zero:

$$\begin{aligned} \frac{\|F(p+h) - F(p) - BAh\|}{\|h\|} &= \frac{\|g(f(p+h)) - g(f(p)) - BAh\|}{\|h\|} \\ &= \frac{\|g(q+k) - g(q) - B(k-r(h))\|}{\|h\|} \\ &\leq \frac{\|g(q+k) - g(q) - Bk\|}{\|h\|} + \|B\| \frac{\|r(h)\|}{\|h\|} \\ &= \frac{\|g(q+k) - g(q) - Bk\|}{\|k\|} \frac{\|f(p+h) - f(p)\|}{\|h\|} + \|B\| \frac{\|r(h)\|}{\|h\|}. \end{aligned}$$

First, $\|B\|$ is a constant and f is differentiable at p , so the term $\|B\| \frac{\|r(h)\|}{\|h\|}$ goes to 0. Next because f is continuous at p , then as h goes to 0, so k goes to 0. Thus $\frac{\|g(q+k) - g(q) - Bk\|}{\|k\|}$ goes to 0, because g is differentiable at q . Finally,

$$\frac{\|f(p+h) - f(p)\|}{\|h\|} \leq \frac{\|f(p+h) - f(p) - Ah\|}{\|h\|} + \frac{\|Ah\|}{\|h\|} \leq \frac{\|f(p+h) - f(p) - Ah\|}{\|h\|} + \|A\|.$$

As f is differentiable at p , for small enough h , the quantity $\frac{\|f(p+h) - f(p) - Ah\|}{\|h\|}$ is bounded. Hence, the term $\frac{\|f(p+h) - f(p)\|}{\|h\|}$ stays bounded as h goes to 0. Therefore, $\frac{\|F(p+h) - F(p) - BAh\|}{\|h\|}$ goes to zero, and $F'(p) = BA$, which is what was claimed. \square

8.3.2 Partial derivatives

There is another way to generalize the derivative from one dimension. We hold all but one variable constant and take the regular derivative.

Definition 8.3.8. Let $f: U \rightarrow \mathbb{R}$ be a function on an open set $U \subset \mathbb{R}^n$. If the following limit exists, we write

$$\frac{\partial f}{\partial x_j}(x) := \lim_{h \rightarrow 0} \frac{f(x_1, \dots, x_{j-1}, x_j + h, x_{j+1}, \dots, x_n) - f(x)}{h} = \lim_{h \rightarrow 0} \frac{f(x + he_j) - f(x)}{h}.$$

We call $\frac{\partial f}{\partial x_j}(x)$ the *partial derivative* of f with respect to x_j . See [Figure 8.4](#). Here h is a number not a vector.

For a mapping $f: U \rightarrow \mathbb{R}^m$ we write $f = (f_1, f_2, \dots, f_m)$, where f_k are real-valued functions. We then take partial derivatives of the components, $\frac{\partial f_k}{\partial x_j}$.

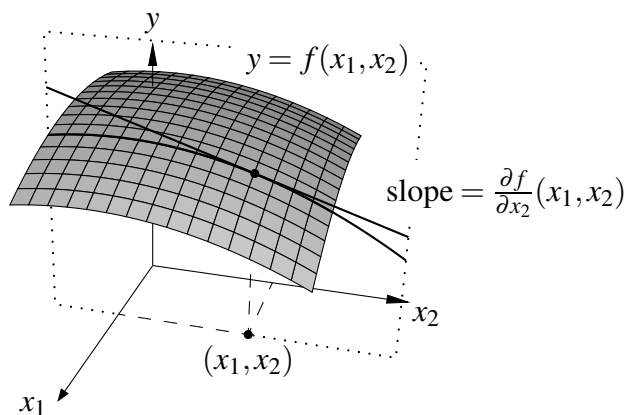

Figure 8.4: Illustration of a partial derivative for a function $f: \mathbb{R}^2 \rightarrow \mathbb{R}$. The yx_2 -plane where x_1 is fixed is marked in dotted line, and the slope of the tangent line in the yx_2 -plane is $\frac{\partial f}{\partial x_2}(x_1, x_2)$.

Partial derivatives are easier to compute with all the machinery of calculus, and they provide a way to compute the derivative of a function.

Proposition 8.3.9. *Let $U \subset \mathbb{R}^n$ be open and let $f: U \rightarrow \mathbb{R}^m$ be differentiable at $p \in U$. Then all the partial derivatives at p exist and, in terms of the standard bases of \mathbb{R}^n and \mathbb{R}^m , $f'(p)$ is represented by the matrix*

$$\begin{bmatrix} \frac{\partial f_1}{\partial x_1}(p) & \frac{\partial f_1}{\partial x_2}(p) & \cdots & \frac{\partial f_1}{\partial x_n}(p) \\ \frac{\partial f_2}{\partial x_1}(p) & \frac{\partial f_2}{\partial x_2}(p) & \cdots & \frac{\partial f_2}{\partial x_n}(p) \\ \vdots & \vdots & \ddots & \vdots \\ \frac{\partial f_m}{\partial x_1}(p) & \frac{\partial f_m}{\partial x_2}(p) & \cdots & \frac{\partial f_m}{\partial x_n}(p) \end{bmatrix}.$$

In other words,

$$f'(p) e_j = \sum_{k=1}^m \frac{\partial f_k}{\partial x_j}(p) e_k.$$

If $v = \sum_{j=1}^n c_j e_j = (c_1, c_2, \dots, c_n)$, then

$$f'(p) v = \sum_{j=1}^n \sum_{k=1}^m c_j \frac{\partial f_k}{\partial x_j}(p) e_k = \sum_{k=1}^m \left(\sum_{j=1}^n c_j \frac{\partial f_k}{\partial x_j}(p) \right) e_k.$$

Proof. Fix a j and note that

$$\begin{aligned} \left\| \frac{f(p + h e_j) - f(p)}{h} - f'(p) e_j \right\| &= \left\| \frac{f(p + h e_j) - f(p) - f'(p) h e_j}{h} \right\| \\ &= \frac{\|f(p + h e_j) - f(p) - f'(p) h e_j\|}{\|h e_j\|}. \end{aligned}$$

As h goes to 0, the right-hand side goes to zero by differentiability of f , and hence

$$\lim_{h \rightarrow 0} \frac{f(p + h e_j) - f(p)}{h} = f'(p) e_j.$$

Let us represent f by components $f = (f_1, f_2, \dots, f_m)$, since it is vector-valued. Taking a limit in \mathbb{R}^m is the same as taking the limit in each component separately. For every k , the partial derivative

$$\frac{\partial f_k}{\partial x_j}(p) = \lim_{h \rightarrow 0} \frac{f_k(p + h e_j) - f_k(p)}{h}$$

exists and is equal to the k th component of $f'(p) e_j$, and we are done. \square

The converse of the proposition is not true. Just because the partial derivatives exist, does not mean that the function is differentiable. See the exercises. However, when the partial derivatives are continuous, we will prove that the converse holds. One of the consequences of the proposition is that if f is differentiable on U , then $f': U \rightarrow L(\mathbb{R}^n, \mathbb{R}^m)$ is a continuous function if and only if all the $\frac{\partial f_k}{\partial x_j}$ are continuous functions.

8.3.3 Gradients, curves, and directional derivatives

Let $U \subset \mathbb{R}^n$ be open and $f: U \rightarrow \mathbb{R}$ a differentiable function. We define the *gradient* as

$$\nabla f(x) := \sum_{j=1}^n \frac{\partial f}{\partial x_j}(x) e_j.$$

The gradient gives a way to represent the action of the derivative as a dot product: $f'(x)v = \nabla f(x) \cdot v$.

Suppose $\gamma: (a, b) \subset \mathbb{R} \rightarrow \mathbb{R}^n$ is a differentiable function. Such a function and its image is sometimes called a *curve*, or a *differentiable curve*. Write $\gamma = (\gamma_1, \gamma_2, \dots, \gamma_n)$. For the purposes of computation we identify $L(\mathbb{R}^1)$ and \mathbb{R} as we did when we defined the derivative in one variable. We also identify $L(\mathbb{R}^1, \mathbb{R}^n)$ with \mathbb{R}^n . We treat $\gamma'(t)$ both as an operator in $L(\mathbb{R}^1, \mathbb{R}^n)$ and the vector $(\gamma_1'(t), \gamma_2'(t), \dots, \gamma_n'(t))$ in \mathbb{R}^n . Using [Proposition 8.3.9](#), if $v \in \mathbb{R}^n$ is $\gamma'(t)$ acting as a vector, then $h \mapsto hv$ (for $h \in \mathbb{R}^1 = \mathbb{R}$) is $\gamma'(t)$ acting as an operator in $L(\mathbb{R}^1, \mathbb{R}^n)$. We often use this slight abuse of notation when dealing with curves. See [Figure 8.5](#).

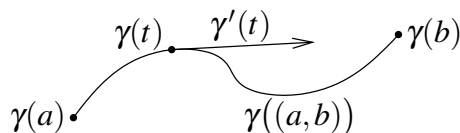

Figure 8.5: Differentiable curve and its derivative as a vector.

Suppose $\gamma((a, b)) \subset U$ and let

$$g(t) := f(\gamma(t)).$$

The function g is differentiable. Treating $g'(t)$ as a number,

$$g'(t) = f'(\gamma(t))\gamma'(t) = \sum_{j=1}^n \frac{\partial f}{\partial x_j}(\gamma(t)) \frac{d\gamma_j}{dt}(t) = \sum_{j=1}^n \frac{\partial f}{\partial x_j} \frac{d\gamma_j}{dt}.$$

For convenience, we often leave out the points where we are evaluating, such as above on the far right-hand side. With the notation of the gradient and the dot product the equation becomes

$$g'(t) = (\nabla f)(\gamma(t)) \cdot \gamma'(t) = \nabla f \cdot \gamma'.$$

We use this idea to define derivatives in a specific direction. A direction is simply a vector pointing in that direction. Pick a vector $u \in \mathbb{R}^n$ such that $\|u\| = 1$, and fix $x \in U$. We define the *directional derivative* as

$$D_u f(x) := \left. \frac{d}{dt} \right|_{t=0} [f(x+tu)] = \lim_{h \rightarrow 0} \frac{f(x+hu) - f(x)}{h},$$

where the notation $\left. \frac{d}{dt} \right|_{t=0}$ represents the derivative evaluated at $t = 0$. Taking the standard basis vector e_j we find $\frac{\partial f}{\partial x_j} = D_{e_j} f$. For this reason, sometimes the notation $\frac{\partial f}{\partial u}$ is used instead of $D_u f$.

Let γ be defined by

$$\gamma(t) := x + tu.$$

Then $\gamma'(t) = u$ for all t . By the computation above:

$$D_u f(x) = \left. \frac{d}{dt} \right|_{t=0} [f(x+tu)] = (\nabla f)(\gamma(0)) \cdot \gamma'(0) = (\nabla f)(x) \cdot u.$$

Suppose $(\nabla f)(x) \neq 0$. By the Cauchy–Schwarz inequality,

$$|D_u f(x)| \leq \|(\nabla f)(x)\|.$$

Equality is achieved when u is a scalar multiple of $(\nabla f)(x)$. That is, when

$$u = \frac{(\nabla f)(x)}{\|(\nabla f)(x)\|},$$

we get $D_u f(x) = \|(\nabla f)(x)\|$. The gradient points in the direction in which the function grows fastest, in other words, in the direction in which $D_u f(x)$ is maximal.

8.3.4 The Jacobian

Definition 8.3.10. Let $U \subset \mathbb{R}^n$ and $f: U \rightarrow \mathbb{R}^n$ be a differentiable mapping. Define the *Jacobian*^{*}, or the *Jacobian determinant*[†], of f at x as

$$J_f(x) := \det(f'(x)).$$

Sometimes J_f is written as

$$\frac{\partial(f_1, f_2, \dots, f_n)}{\partial(x_1, x_2, \dots, x_n)}.$$

^{*}Named after the Italian mathematician **Carl Gustav Jacob Jacobi** (1804–1851).

[†]The matrix from [Proposition 8.3.9](#) representing $f'(x)$ is sometimes called the *Jacobian matrix*.

This last piece of notation may seem somewhat confusing, but it is quite useful when we need to specify the exact variables and function components used, as will for example do in the implicit function theorem.

The Jacobian J_f is a real-valued function, and when $n = 1$ it is simply the derivative. From the chain rule and the fact that $\det(AB) = \det(A)\det(B)$, it follows that:

$$J_{f \circ g}(x) = J_f(g(x))J_g(x).$$

The determinant of a linear mapping tells us what happens to area/volume under the mapping. Similarly, the Jacobian measures how much a differentiable mapping stretches things locally, and if it flips orientation. In particular, if the Jacobian is non-zero then we would assume that locally the mapping is invertible (and we would be correct as we will later see).

8.3.5 Exercises

Exercise 8.3.1: Suppose $\gamma: (-1, 1) \rightarrow \mathbb{R}^n$ and $\alpha: (-1, 1) \rightarrow \mathbb{R}^n$ are two differentiable curves such that $\gamma(0) = \alpha(0)$ and $\gamma'(0) = \alpha'(0)$. Suppose $F: \mathbb{R}^n \rightarrow \mathbb{R}$ is a differentiable function. Show that

$$\left. \frac{d}{dt} \right|_{t=0} F(\gamma(t)) = \left. \frac{d}{dt} \right|_{t=0} F(\alpha(t)).$$

Exercise 8.3.2: Let $f: \mathbb{R}^2 \rightarrow \mathbb{R}$ be given by $f(x, y) := \sqrt{x^2 + y^2}$, see [Figure 8.6](#). Show that f is not differentiable at the origin.

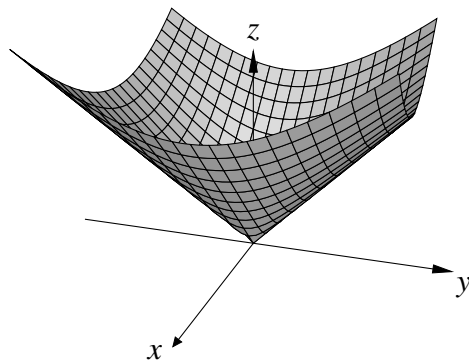

Figure 8.6: Graph of $\sqrt{x^2 + y^2}$.

Exercise 8.3.3: Using only the definition of the derivative, show that the following $f: \mathbb{R}^2 \rightarrow \mathbb{R}^2$ are differentiable at the origin and find their derivative.

- $f(x, y) := (1 + x + xy, x)$,
- $f(x, y) := (y - y^{10}, x)$,
- $f(x, y) := ((x + y + 1)^2, (x - y + 2)^2)$.

Exercise 8.3.4: Suppose $f: \mathbb{R} \rightarrow \mathbb{R}$ and $g: \mathbb{R} \rightarrow \mathbb{R}$ are differentiable functions. Using only the definition of the derivative, show that $h: \mathbb{R}^2 \rightarrow \mathbb{R}^2$ defined by $h(x, y) := (f(x), g(y))$ is a differentiable function, and find the derivative, at all points (x, y) .

Exercise 8.3.5: Define a function $f: \mathbb{R}^2 \rightarrow \mathbb{R}$ by (see Figure 8.7)

$$f(x, y) := \begin{cases} \frac{xy}{x^2+y^2} & \text{if } (x, y) \neq (0, 0), \\ 0 & \text{if } (x, y) = (0, 0). \end{cases}$$

- Show that the partial derivatives $\frac{\partial f}{\partial x}$ and $\frac{\partial f}{\partial y}$ exist at all points (including the origin).
- Show that f is not continuous at the origin (and hence not differentiable).

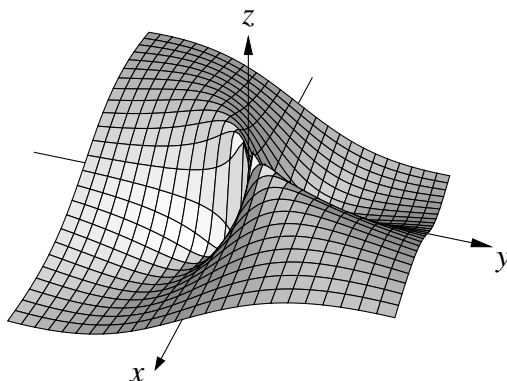

Figure 8.7: Graph of $\frac{xy}{x^2+y^2}$.

Exercise 8.3.6: Define a function $f: \mathbb{R}^2 \rightarrow \mathbb{R}$ by (see Figure 8.8)

$$f(x, y) := \begin{cases} \frac{x^2y}{x^2+y^2} & \text{if } (x, y) \neq (0, 0), \\ 0 & \text{if } (x, y) = (0, 0). \end{cases}$$

- Show that the partial derivatives $\frac{\partial f}{\partial x}$ and $\frac{\partial f}{\partial y}$ exist at all points.
- Show that for all $u \in \mathbb{R}^2$ with $\|u\| = 1$, the directional derivative $D_u f$ exists at all points.
- Show that f is continuous at the origin.
- Show that f is not differentiable at the origin.

Exercise 8.3.7: Suppose $f: \mathbb{R}^n \rightarrow \mathbb{R}^n$ is one-to-one, onto, differentiable at all points, and such that f^{-1} is also differentiable at all points.

- Show that $f'(p)$ is invertible at all points p and compute $(f^{-1})'(f(p))$. Hint: Consider $x = f^{-1}(f(x))$.
- Let $g: \mathbb{R}^n \rightarrow \mathbb{R}^n$ be a function differentiable at $q \in \mathbb{R}^n$ and such that $g(q) = q$. Suppose $f(p) = q$ for some $p \in \mathbb{R}^n$. Show $J_g(q) = J_{f^{-1} \circ g \circ f}(p)$ where J_g is the Jacobian determinant.

Exercise 8.3.8: Suppose $f: \mathbb{R}^2 \rightarrow \mathbb{R}$ is differentiable and such that $f(x, y) = 0$ if and only if $y = 0$ and such that $\nabla f(0, 0) = (0, 1)$. Prove that $f(x, y) > 0$ whenever $y > 0$, and $f(x, y) < 0$ whenever $y < 0$.

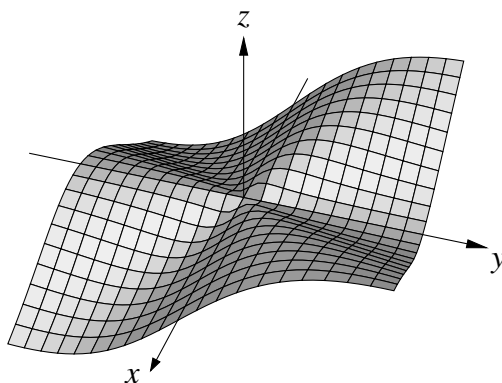

Figure 8.8: Graph of $\frac{x^2y}{x^2+y^2}$.

As for functions of one variable, $f: U \rightarrow \mathbb{R}$ has a *relative maximum* at $p \in U$ if there exists a $\delta > 0$ such that $f(q) \leq f(p)$ for all $q \in B(p, \delta) \cap U$. Similarly for *relative minimum*.

Exercise 8.3.9: Suppose $U \subset \mathbb{R}^n$ is open and $f: U \rightarrow \mathbb{R}$ is differentiable. Suppose f has a relative maximum at $p \in U$. Show that $f'(p) = 0$, that is the zero mapping in $L(\mathbb{R}^n, \mathbb{R})$. That is p is a critical point of f .

Exercise 8.3.10: Suppose $f: \mathbb{R}^2 \rightarrow \mathbb{R}$ is differentiable and $f(x, y) = 0$ whenever $x^2 + y^2 = 1$. Prove that there exists at least one point (x_0, y_0) such that $\frac{\partial f}{\partial x}(x_0, y_0) = \frac{\partial f}{\partial y}(x_0, y_0) = 0$.

Exercise 8.3.11: Define $f(x, y) := (x - y^2)(2y^2 - x)$. The graph of f is called the Peano surface.*

- Show that $(0, 0)$ is a critical point, that is $f'(0, 0) = 0$, that is the zero linear map in $L(\mathbb{R}^2, \mathbb{R})$.
- Show that for every direction the restriction of f to a line through the origin in that direction has a relative maximum at the origin. In other words, for every (x, y) such that $x^2 + y^2 = 1$, the function $g(t) := f(tx, ty)$, has a relative maximum at $t = 0$.
Hint: While not necessary §4.3 of volume I makes this part easier.
- Show that f does not have a relative maximum at $(0, 0)$.

Exercise 8.3.12: Suppose $f: \mathbb{R} \rightarrow \mathbb{R}^n$ is differentiable and $\|f(t)\| = 1$ for all t (that is, we have a curve in the unit sphere). Show that $f'(t) \cdot f(t) = 0$ (treating f' as a vector) for all t .

Exercise 8.3.13: Define $f: \mathbb{R}^2 \rightarrow \mathbb{R}^2$ by $f(x, y) := (x, y + \varphi(x))$ for some differentiable function φ of one variable. Show f is differentiable and find f' .

Exercise 8.3.14: Suppose $U \subset \mathbb{R}^n$ is open, $p \in U$, and $f: U \rightarrow \mathbb{R}$, $g: U \rightarrow \mathbb{R}$, $h: U \rightarrow \mathbb{R}$ are functions such that $f(p) = g(p) = h(p)$, f and h are differentiable at p , $f'(p) = h'(p)$, and

$$f(x) \leq g(x) \leq h(x)$$

for all $x \in U$. Show that g is differentiable at p and $g'(p) = f'(p) = h'(p)$.

*Named after the Italian mathematician [Giuseppe Peano](#) (1858–1932).

8.4 Continuity and the derivative

Note: 1–2 lectures

8.4.1 Bounding the derivative

Let us prove a “mean value theorem” for vector-valued functions.

Lemma 8.4.1. *If $\varphi: [a, b] \rightarrow \mathbb{R}^n$ is differentiable on (a, b) and continuous on $[a, b]$, then there exists a $t_0 \in (a, b)$ such that*

$$\|\varphi(b) - \varphi(a)\| \leq (b - a)\|\varphi'(t_0)\|.$$

Proof. By the mean value theorem on the scalar-valued function $t \mapsto (\varphi(b) - \varphi(a)) \cdot \varphi(t)$, where the dot is the dot product, we obtain that there is a $t_0 \in (a, b)$ such that

$$\begin{aligned} \|\varphi(b) - \varphi(a)\|^2 &= (\varphi(b) - \varphi(a)) \cdot (\varphi(b) - \varphi(a)) \\ &= (\varphi(b) - \varphi(a)) \cdot \varphi(b) - (\varphi(b) - \varphi(a)) \cdot \varphi(a) \\ &= (b - a)(\varphi(b) - \varphi(a)) \cdot \varphi'(t_0), \end{aligned}$$

where we treat φ' as a vector in \mathbb{R}^n by the abuse of notation we mentioned in the previous section. If we think of $\varphi'(t)$ as a vector, then by [Exercise 8.2.6](#), $\|\varphi'(t)\|_{L(\mathbb{R}, \mathbb{R}^n)} = \|\varphi'(t)\|_{\mathbb{R}^n}$. That is, the euclidean norm of the vector is the same as the operator norm of $\varphi'(t)$.

By the Cauchy–Schwarz inequality

$$\|\varphi(b) - \varphi(a)\|^2 = (b - a)(\varphi(b) - \varphi(a)) \cdot \varphi'(t_0) \leq (b - a)\|\varphi(b) - \varphi(a)\|\|\varphi'(t_0)\|. \quad \square$$

Recall that a set U is convex if whenever $x, y \in U$, the line segment from x to y lies in U .

Proposition 8.4.2. *Let $U \subset \mathbb{R}^n$ be a convex open set, $f: U \rightarrow \mathbb{R}^m$ be a differentiable function, and an M be such that*

$$\|f'(x)\| \leq M \quad \text{for all } x \in U.$$

Then f is Lipschitz with constant M , that is

$$\|f(x) - f(y)\| \leq M\|x - y\| \quad \text{for all } x, y \in U.$$

Proof. Fix x and y in U and note that $(1 - t)x + ty \in U$ for all $t \in [0, 1]$ by convexity. Next

$$\frac{d}{dt} \left[f((1 - t)x + ty) \right] = f'((1 - t)x + ty)(y - x).$$

By [Lemma 8.4.1](#) there is some $t_0 \in (0, 1)$ such that

$$\begin{aligned} \|f(x) - f(y)\| &\leq \left\| \frac{d}{dt} \Big|_{t=t_0} \left[f((1 - t)x + ty) \right] \right\| \\ &\leq \|f'((1 - t_0)x + t_0y)\| \|y - x\| \leq M\|y - x\|. \end{aligned} \quad \square$$

Example 8.4.3: If U is not convex the proposition is not true: Consider the set

$$U := \{(x, y) : 0.5 < x^2 + y^2 < 2\} \setminus \{(x, 0) : x < 0\}.$$

For $(x, y) \in U$, let $f(x, y)$ be the angle that the line from the origin to (x, y) makes with the positive x axis. We even have a formula for f :

$$f(x, y) = 2 \arctan \left(\frac{y}{x + \sqrt{x^2 + y^2}} \right).$$

Think a spiral staircase with room in the middle. See Figure 8.9.

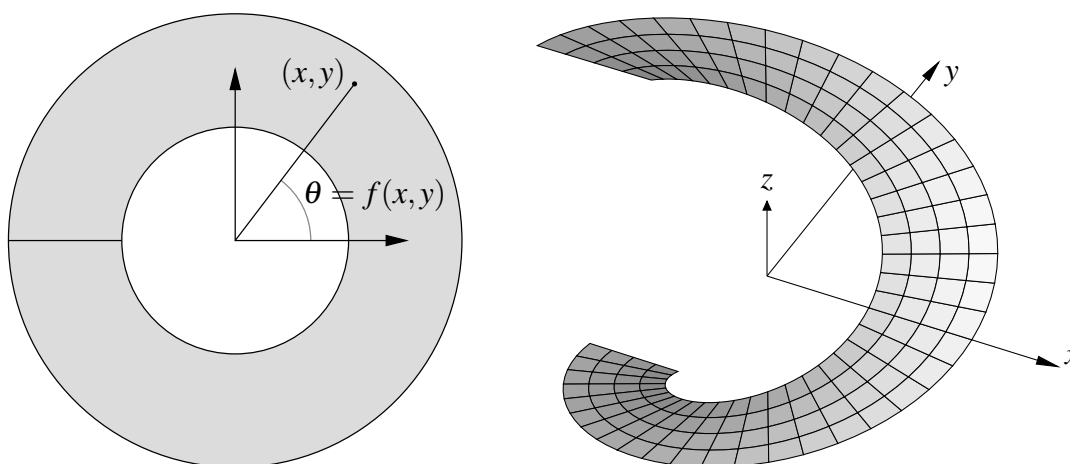

Figure 8.9: A non-Lipschitz function with uniformly bounded derivative.

The function is differentiable, and the derivative is bounded on U , which is not hard to see. Now think of what happens near where the negative x -axis cuts the annulus in half. As we approach this cut from positive y , $f(x, y)$ approaches π . From negative y , $f(x, y)$ approaches $-\pi$. So for small $\varepsilon > 0$, $|f(-1, \varepsilon) - f(-1, -\varepsilon)|$ approaches 2π , but $\|(-1, \varepsilon) - (-1, -\varepsilon)\| = 2\varepsilon$, which is arbitrarily small. The conclusion of the proposition does not hold for this nonconvex U .

Let us solve the differential equation $f' = 0$.

Corollary 8.4.4. *If $U \subset \mathbb{R}^n$ is open and connected, $f: U \rightarrow \mathbb{R}^m$ is differentiable, and $f'(x) = 0$ for all $x \in U$, then f is constant.*

Proof. For any given $x \in U$, there is a ball $B(x, \delta) \subset U$. The ball $B(x, \delta)$ is convex. Since $\|f'(y)\| \leq 0$ for all $y \in B(x, \delta)$, then by the proposition, $\|f(x) - f(y)\| \leq 0\|x - y\| = 0$. So $f(x) = f(y)$ for all $y \in B(x, \delta)$.

This means that $f^{-1}(c)$ is open for all $c \in \mathbb{R}^m$. Suppose $f^{-1}(c)$ is nonempty. The two sets

$$U' = f^{-1}(c), \quad U'' = f^{-1}(\mathbb{R}^m \setminus \{c\})$$

are open and disjoint, and further $U = U' \cup U''$. As U' is nonempty and U is connected, then $U'' = \emptyset$. So $f(x) = c$ for all $x \in U$. \square

8.4.2 Continuously differentiable functions

Definition 8.4.5. Let $U \subset \mathbb{R}^n$ be open. We say $f: U \rightarrow \mathbb{R}^m$ is *continuously differentiable*, or $C^1(U)$, if f is differentiable and $f': U \rightarrow L(\mathbb{R}^n, \mathbb{R}^m)$ is continuous.

Proposition 8.4.6. Let $U \subset \mathbb{R}^n$ be open and $f: U \rightarrow \mathbb{R}^m$. The function f is continuously differentiable if and only if the partial derivatives $\frac{\partial f_j}{\partial x_\ell}$ exist for all j and ℓ and are continuous.

Without continuity the theorem does not hold. Just because partial derivatives exist does not mean that f is differentiable, in fact, f may not even be continuous. See the exercises for the last section and also for this section.

Proof. We proved that if f is differentiable, then the partial derivatives exist. The partial derivatives are the entries of the matrix of $f'(x)$. If $f': U \rightarrow L(\mathbb{R}^n, \mathbb{R}^m)$ is continuous, then the entries are continuous, and hence the partial derivatives are continuous.

To prove the opposite direction, suppose the partial derivatives exist and are continuous. Fix $x \in U$. If we show that $f'(x)$ exists we are done, because the entries of the matrix $f'(x)$ are the partial derivatives and if the entries are continuous functions, the matrix-valued function f' is continuous.

We do induction on dimension. First, the conclusion is true when $n = 1$. In this case the derivative is just the regular derivative (exercise, noting that f is vector-valued).

Suppose the conclusion is true for \mathbb{R}^{n-1} , that is, if we restrict to the first $n - 1$ variables, the function is differentiable. It is easy to see that the first $n - 1$ partial derivatives of f restricted to the set where the last coordinate is fixed are the same as those for f . In the following, by a slight abuse of notation, we think of \mathbb{R}^{n-1} as a subset of \mathbb{R}^n , that is the set in \mathbb{R}^n where $x_n = 0$. In other words, we identify the vectors $(x_1, x_2, \dots, x_{n-1})$ and $(x_1, x_2, \dots, x_{n-1}, 0)$. Let

$$A := \begin{bmatrix} \frac{\partial f_1}{\partial x_1}(x) & \cdots & \frac{\partial f_1}{\partial x_n}(x) \\ \vdots & \ddots & \vdots \\ \frac{\partial f_m}{\partial x_1}(x) & \cdots & \frac{\partial f_m}{\partial x_n}(x) \end{bmatrix}, \quad A' := \begin{bmatrix} \frac{\partial f_1}{\partial x_1}(x) & \cdots & \frac{\partial f_1}{\partial x_{n-1}}(x) \\ \vdots & \ddots & \vdots \\ \frac{\partial f_m}{\partial x_1}(x) & \cdots & \frac{\partial f_m}{\partial x_{n-1}}(x) \end{bmatrix}, \quad v := \begin{bmatrix} \frac{\partial f_1}{\partial x_n}(x) \\ \vdots \\ \frac{\partial f_m}{\partial x_n}(x) \end{bmatrix}.$$

Let $\varepsilon > 0$ be given. By the induction hypothesis, there is a $\delta > 0$ such that for every $k \in \mathbb{R}^{n-1}$ with $\|k\| < \delta$, we have

$$\frac{\|f(x+k) - f(x) - A'k\|}{\|k\|} < \varepsilon.$$

By continuity of the partial derivatives, suppose δ is small enough so that

$$\left| \frac{\partial f_j}{\partial x_n}(x+h) - \frac{\partial f_j}{\partial x_n}(x) \right| < \varepsilon$$

for all j and all $h \in \mathbb{R}^n$ with $\|h\| < \delta$.

Suppose $h = k + te_n$ is a vector in \mathbb{R}^n , where $k \in \mathbb{R}^{n-1}$, $t \in \mathbb{R}$, such that $\|h\| < \delta$. Then $\|k\| \leq \|h\| < \delta$. Note that $Ah = A'k + tv$.

$$\begin{aligned} \|f(x+h) - f(x) - Ah\| &= \|f(x+k+te_n) - f(x+k) - tv + f(x+k) - f(x) - A'k\| \\ &\leq \|f(x+k+te_n) - f(x+k) - tv\| + \|f(x+k) - f(x) - A'k\| \\ &\leq \|f(x+k+te_n) - f(x+k) - tv\| + \varepsilon\|k\|. \end{aligned}$$

As all the partial derivatives exist, by the mean value theorem, for each j there is some $\theta_j \in [0, t]$ (or $[t, 0]$ if $t < 0$), such that

$$f_j(x+k+te_n) - f_j(x+k) = t \frac{\partial f_j}{\partial x_n}(x+k+\theta_j e_n).$$

Note that if $\|h\| < \delta$, then $\|k + \theta_j e_n\| \leq \|h\| < \delta$. We finish the estimate

$$\begin{aligned} \|f(x+h) - f(x) - Ah\| &\leq \|f(x+k+te_n) - f(x+k) - tv\| + \varepsilon\|k\| \\ &\leq \sqrt{\sum_{j=1}^m \left(t \frac{\partial f_j}{\partial x_n}(x+k+\theta_j e_n) - t \frac{\partial f_j}{\partial x_n}(x) \right)^2} + \varepsilon\|k\| \\ &\leq \sqrt{m} \varepsilon |t| + \varepsilon\|k\| \\ &\leq (\sqrt{m} + 1) \varepsilon \|h\|. \end{aligned} \quad \square$$

A common application is to prove that a certain function is differentiable. For example, let us show that all polynomials are differentiable, and in fact continuously differentiable by computing the partial derivatives.

Corollary 8.4.7. *A polynomial $p: \mathbb{R}^n \rightarrow \mathbb{R}$ in several variables*

$$p(x_1, x_2, \dots, x_n) = \sum_{0 \leq j_1 + j_2 + \dots + j_n \leq d} c_{j_1, j_2, \dots, j_n} x_1^{j_1} x_2^{j_2} \dots x_n^{j_n}$$

is continuously differentiable.

Proof. Consider the partial derivative of p in the x_n variable. Write p as

$$p(x) = \sum_{j=0}^d p_j(x_1, \dots, x_{n-1}) x_n^j,$$

where p_j are polynomials in one less variable. Then

$$\frac{\partial p}{\partial x_n}(x) = \sum_{j=1}^d p_j(x_1, \dots, x_{n-1}) j x_n^{j-1},$$

which is again a polynomial. So the partial derivatives of polynomials exist and are again polynomials. By the continuity of algebraic operations, polynomials are continuous functions. Therefore p is continuously differentiable. \square

8.4.3 Exercises

Exercise 8.4.1: Define $f: \mathbb{R}^2 \rightarrow \mathbb{R}$ as

$$f(x, y) := \begin{cases} (x^2 + y^2) \sin((x^2 + y^2)^{-1}) & \text{if } (x, y) \neq (0, 0), \\ 0 & \text{if } (x, y) = (0, 0). \end{cases}$$

Show that f is differentiable at the origin, but that it is not continuously differentiable.

Note: Feel free to use what you know about sine and cosine from calculus.

Exercise 8.4.2: Let $f: \mathbb{R}^2 \rightarrow \mathbb{R}$ be the function from [Exercise 8.3.5](#), that is,

$$f(x, y) := \begin{cases} \frac{xy}{x^2+y^2} & \text{if } (x, y) \neq (0, 0), \\ 0 & \text{if } (x, y) = (0, 0). \end{cases}$$

Compute the partial derivatives $\frac{\partial f}{\partial x}$ and $\frac{\partial f}{\partial y}$ at all points and show that these are not continuous functions.

Exercise 8.4.3: Let $B(0, 1) \subset \mathbb{R}^2$ be the unit ball (disc), that is, the set given by $x^2 + y^2 < 1$. Suppose $f: B(0, 1) \rightarrow \mathbb{R}$ is a differentiable function such that $|f(0, 0)| \leq 1$, and $|\frac{\partial f}{\partial x}| \leq 1$ and $|\frac{\partial f}{\partial y}| \leq 1$ for all points in $B(0, 1)$.

a) Find an $M \in \mathbb{R}$ such that $\|f'(x, y)\| \leq M$ for all $(x, y) \in B(0, 1)$.

b) Find a $B \in \mathbb{R}$ such that $|f(x, y)| \leq B$ for all $(x, y) \in B(0, 1)$.

Exercise 8.4.4: Define $\varphi: [0, 2\pi] \rightarrow \mathbb{R}^2$ by $\varphi(t) = (\sin(t), \cos(t))$. Compute $\varphi'(t)$ for all t . Compute $\|\varphi'(t)\|$ for all t . Notice that $\varphi'(t)$ is never zero, yet $\varphi(0) = \varphi(2\pi)$, therefore, Rolle's theorem is not true in more than one dimension.

Exercise 8.4.5: Let $f: \mathbb{R}^2 \rightarrow \mathbb{R}$ be a function such that $\frac{\partial f}{\partial x}$ and $\frac{\partial f}{\partial y}$ exist at all points and there exists an $M \in \mathbb{R}$ such that $|\frac{\partial f}{\partial x}| \leq M$ and $|\frac{\partial f}{\partial y}| \leq M$ at all points. Show that f is continuous.

Exercise 8.4.6: Let $f: \mathbb{R}^2 \rightarrow \mathbb{R}$ be a function and $M \in \mathbb{R}$, such that for every $(x, y) \in \mathbb{R}^2$, the function $g(t) := f(xt, yt)$ is differentiable and $|g'(t)| \leq M$.

a) Show that f is continuous at $(0, 0)$.

b) Find an example of such an f that is discontinuous at every other point of \mathbb{R}^2 .

Hint: Think back to how we constructed a nowhere continuous function on $[0, 1]$.

Exercise 8.4.7: Suppose $r: \mathbb{R}^n \setminus X \rightarrow \mathbb{R}$ is a rational function, that is, let $p: \mathbb{R}^n \rightarrow \mathbb{R}$ and $q: \mathbb{R}^n \rightarrow \mathbb{R}$ be polynomials, q not identically zero, where $X = q^{-1}(0)$, and $r = \frac{p}{q}$. Show that r is continuously differentiable.

Exercise 8.4.8: Suppose $f: \mathbb{R}^n \rightarrow \mathbb{R}$ and $h: \mathbb{R}^n \rightarrow \mathbb{R}$ are two differentiable functions such that $f'(x) = h'(x)$ for all $x \in \mathbb{R}^n$. Prove that if $f(0) = h(0)$, then $f(x) = h(x)$ for all $x \in \mathbb{R}^n$.

Exercise 8.4.9: Prove the base case in [Proposition 8.4.6](#). That is, prove that if $n = 1$ and “the partials exist and are continuous,” then the function is continuously differentiable. Note that f is vector-valued.

Exercise 8.4.10: Suppose $g: \mathbb{R} \rightarrow \mathbb{R}$ is continuously differentiable and $h: \mathbb{R}^2 \rightarrow \mathbb{R}$ is continuous. Show that

$$F(x, y) := g(x) + \int_0^y h(x, s) ds$$

is continuously differentiable, and that it is the solution of the partial differential equation $\frac{\partial F}{\partial y} = h$, with the initial condition $F(x, 0) = g(x)$ for all $x \in \mathbb{R}$.

8.5 Inverse and implicit function theorems

Note: 2–3 lectures

To prove the inverse function theorem we use the contraction mapping principle from chapter 7, where we used it to prove Picard’s theorem. Recall that a mapping $f: X \rightarrow Y$ between two metric spaces (X, d_X) and (Y, d_Y) is called a contraction if there exists a $k < 1$ such that

$$d_Y(f(p), f(q)) \leq k d_X(p, q) \quad \text{for all } p, q \in X.$$

The contraction mapping principle says that if $f: X \rightarrow X$ is a contraction and X is a complete metric space, then there exists a unique fixed point, that is, there exists a unique $x \in X$ such that $f(x) = x$.

Intuitively, if a function is continuously differentiable, then it locally “behaves like” the derivative (which is a linear function). The idea of the inverse function theorem is that if a function is continuously differentiable and the derivative is invertible, the function is (locally) invertible.

Theorem 8.5.1 (Inverse function theorem). *Let $U \subset \mathbb{R}^n$ be an open set and let $f: U \rightarrow \mathbb{R}^n$ be a continuously differentiable function. Suppose $p \in U$ and $f'(p)$ is invertible (that is, $J_f(p) \neq 0$). Then there exist open sets $V, W \subset \mathbb{R}^n$ such that $p \in V \subset U$, $f(V) = W$ and $f|_V$ is one-to-one. Hence a function $g: W \rightarrow V$ exists such that $g(y) := (f|_V)^{-1}(y)$. See Figure 8.10. Furthermore, g is continuously differentiable and*

$$g'(y) = (f'(x))^{-1}, \quad \text{for all } x \in V, y = f(x).$$

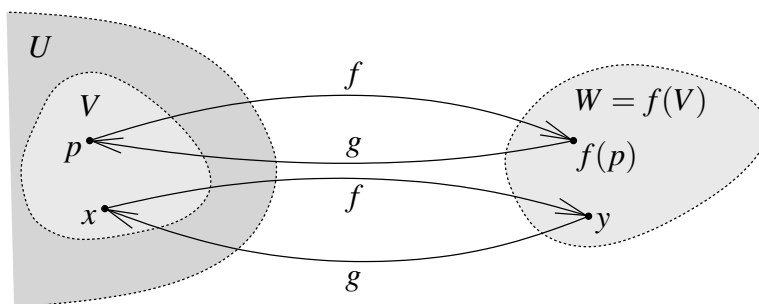

Figure 8.10: Setup of the inverse function theorem in \mathbb{R}^n .

Proof. Write $A = f'(p)$. As f' is continuous, there exists an open ball V around p such that

$$\|A - f'(x)\| < \frac{1}{2\|A^{-1}\|} \quad \text{for all } x \in V.$$

Consequently, the derivative $f'(x)$ is invertible for all $x \in V$ by Proposition 8.2.6.

Given $y \in \mathbb{R}^n$, we define $\varphi_y: V \rightarrow \mathbb{R}^n$ by

$$\varphi_y(x) := x + A^{-1}(y - f(x)).$$

As A^{-1} is one-to-one, $\varphi_y(x) = x$ (x is a fixed point) if and only if $y - f(x) = 0$, or in other words $f(x) = y$. Using the chain rule we obtain

$$\varphi_y'(x) = I - A^{-1}f'(x) = A^{-1}(A - f'(x)).$$

So for $x \in V$, we have

$$\|\varphi_y'(x)\| \leq \|A^{-1}\| \|A - f'(x)\| < 1/2.$$

As V is a ball, it is convex. Hence

$$\|\varphi_y(x_1) - \varphi_y(x_2)\| \leq \frac{1}{2} \|x_1 - x_2\| \quad \text{for all } x_1, x_2 \in V.$$

In other words, φ_y is a contraction defined on V , though we so far do not know what is the range of φ_y . We cannot yet apply the fixed point theorem, but we can say that φ_y has at most one fixed point in V : If $\varphi_y(x_1) = x_1$ and $\varphi_y(x_2) = x_2$, then $\|x_1 - x_2\| = \|\varphi_y(x_1) - \varphi_y(x_2)\| \leq \frac{1}{2} \|x_1 - x_2\|$, so $x_1 = x_2$. That is, there exists at most one $x \in V$ such that $f(x) = y$, and so $f|_V$ is one-to-one.

Let $W := f(V)$. We need to show that W is open. Take a $y_0 \in W$. There is a unique $x_0 \in V$ such that $f(x_0) = y_0$. Let $r > 0$ be small enough such that the closed ball $C(x_0, r) \subset V$ (such $r > 0$ exists as V is open).

Suppose y is such that

$$\|y - y_0\| < \frac{r}{2\|A^{-1}\|}.$$

If we show that $y \in W$, then we have shown that W is open. If $x \in C(x_0, r)$, then

$$\begin{aligned} \|\varphi_y(x) - x_0\| &\leq \|\varphi_y(x) - \varphi_y(x_0)\| + \|\varphi_y(x_0) - x_0\| \\ &\leq \frac{1}{2} \|x - x_0\| + \|A^{-1}(y - y_0)\| \\ &\leq \frac{1}{2} r + \|A^{-1}\| \|y - y_0\| \\ &< \frac{1}{2} r + \|A^{-1}\| \frac{r}{2\|A^{-1}\|} = r. \end{aligned}$$

So φ_y takes $C(x_0, r)$ into $B(x_0, r) \subset C(x_0, r)$. It is a contraction on $C(x_0, r)$ and $C(x_0, r)$ is complete (closed subset of \mathbb{R}^n is complete). Apply the contraction mapping principle to obtain a fixed point x , i.e. $\varphi_y(x) = x$. That is, $f(x) = y$, and $y \in f(C(x_0, r)) \subset f(V) = W$. Therefore W is open.

Next we need to show that g is continuously differentiable and compute its derivative. First let us show that it is differentiable. Let $y \in W$ and $k \in \mathbb{R}^n$, $k \neq 0$, such that $y + k \in W$. Because $f|_V$ is a one-to-one and onto mapping of V onto W , there are unique $x \in V$ and $h \in \mathbb{R}^n$, $h \neq 0$ and $x + h \in V$, such that $f(x) = y$ and $f(x + h) = y + k$. In other words, $g(y) = x$ and $g(y + k) = x + h$. See [Figure 8.11](#).

We can still squeeze some information from the fact that φ_y is a contraction.

$$\varphi_y(x + h) - \varphi_y(x) = h + A^{-1}(f(x) - f(x + h)) = h - A^{-1}k.$$

So

$$\|h - A^{-1}k\| = \|\varphi_y(x + h) - \varphi_y(x)\| \leq \frac{1}{2} \|x + h - x\| = \frac{\|h\|}{2}.$$

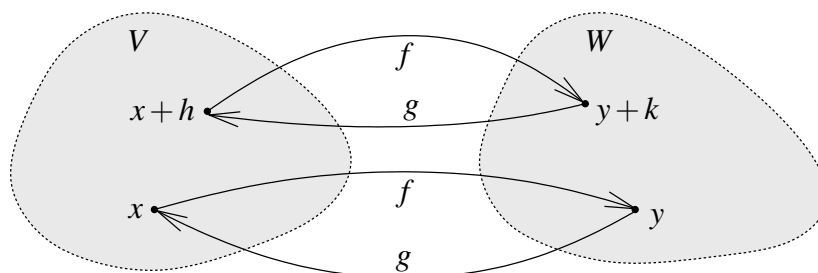

Figure 8.11: Proving that g is differentiable.

By the inverse triangle inequality, $\|h\| - \|A^{-1}k\| \leq \frac{1}{2}\|h\|$. So

$$\|h\| \leq 2\|A^{-1}k\| \leq 2\|A^{-1}\| \|k\|.$$

In particular, as k goes to 0, so does h .

As $x \in V$, then $f'(x)$ is invertible. Let $B := (f'(x))^{-1}$, which is what we think the derivative of g at y is. Then

$$\begin{aligned} \frac{\|g(y+k) - g(y) - Bk\|}{\|k\|} &= \frac{\|h - Bk\|}{\|k\|} \\ &= \frac{\|h - B(f(x+h) - f(x))\|}{\|k\|} \\ &= \frac{\|B(f(x+h) - f(x) - f'(x)h)\|}{\|k\|} \\ &\leq \|B\| \frac{\|h\|}{\|k\|} \frac{\|f(x+h) - f(x) - f'(x)h\|}{\|h\|} \\ &\leq 2\|B\| \|A^{-1}\| \frac{\|f(x+h) - f(x) - f'(x)h\|}{\|h\|}. \end{aligned}$$

As k goes to 0, so does h . So the right-hand side goes to 0 as f is differentiable, and hence the left-hand side also goes to 0. And B is precisely what we wanted $g'(y)$ to be.

We have g is differentiable, let us show it is $C^1(W)$. The function $g: W \rightarrow V$ is continuous (it is differentiable), f' is a continuous function from V to $L(\mathbb{R}^n)$, and $X \mapsto X^{-1}$ is a continuous function on the set of invertible operators. As $g'(y) = (f'(g(y)))^{-1}$ is the composition of these three continuous functions, it is continuous. \square

Corollary 8.5.2. *Suppose $U \subset \mathbb{R}^n$ is open and $f: U \rightarrow \mathbb{R}^n$ is a continuously differentiable mapping such that $f'(x)$ is invertible for all $x \in U$. Then for every open set $V \subset U$, the set $f(V)$ is open (f is said to be an open mapping).*

Proof. Without loss of generality, suppose $U = V$. For each point $y \in f(V)$, we pick $x \in f^{-1}(y)$ (there could be more than one such point), then by the inverse function theorem there is a neighborhood of x in V that maps onto a neighborhood of y . Hence $f(V)$ is open. \square

Example 8.5.3: The theorem, and the corollary, is not true if $f'(x)$ is not invertible for some x . For example, the map $f(x, y) := (x, xy)$, maps \mathbb{R}^2 onto the set $\mathbb{R}^2 \setminus \{(0, y) : y \neq 0\}$, which is neither open nor closed. In fact $f^{-1}(0, 0) = \{(0, y) : y \in \mathbb{R}\}$. This bad behavior only occurs on the y -axis, everywhere else the function is locally invertible. If we avoid the y -axis, f is even one-to-one.

Example 8.5.4: Also note that just because $f'(x)$ is invertible everywhere does not mean that f is one-to-one globally. It is “locally” one-to-one but perhaps not “globally.” For an example, take the map $f: \mathbb{R}^2 \setminus \{0\} \rightarrow \mathbb{R}^2$ defined by $f(x, y) := (x^2 - y^2, 2xy)$. It is left to student to show that f is differentiable and the derivative is invertible.

On the other hand, the mapping f is 2-to-1 globally. For every (a, b) that is not the origin, there are exactly two solutions to $x^2 - y^2 = a$ and $2xy = b$. We leave it to the student to show that there is at least one solution, and then notice that replacing x and y with $-x$ and $-y$ we obtain another solution.

The invertibility of the derivative is not a necessary condition, just sufficient, for having a continuous inverse and being an open mapping. For example, the function $f(x) := x^3$ is an open mapping from \mathbb{R} to \mathbb{R} and is globally one-to-one with a continuous inverse, although the inverse is not differentiable at $x = 0$.

As a side note, there is a related famous, and as yet unsolved problem, called the *Jacobian conjecture*. If $F: \mathbb{R}^n \rightarrow \mathbb{R}^n$ is polynomial (each component is a polynomial) and J_F is a nonzero constant, does F have a polynomial inverse? The inverse function theorem gives a local C^1 inverse, but can one always find a global polynomial inverse is the question.

8.5.1 Implicit function theorem

The inverse function theorem is really a special case of the implicit function theorem, which we prove next. Although somewhat ironically we prove the implicit function theorem using the inverse function theorem. In the inverse function theorem we showed that the equation $x - f(y) = 0$ is solvable for y in terms of x if the derivative in terms of y is invertible, that is if $f'(y)$ is invertible. Then there is (locally) a function g such that $x - f(g(x)) = 0$.

OK, so how about the equation $f(x, y) = 0$. This equation is not solvable for y in terms of x in every case. For example, there is no solution when $f(x, y)$ does not actually depend on y . For a slightly more complicated example, notice that $x^2 + y^2 - 1 = 0$ defines the unit circle, and we can locally solve for y in terms of x when 1) we are near a point that lies on the unit circle and 2) when we are not at a point where the circle has a vertical tangency, or in other words where $\frac{\partial f}{\partial y} = 0$.

To make things simple, we fix some notation. We let $(x, y) \in \mathbb{R}^{n+m}$ denote the coordinates $(x_1, \dots, x_n, y_1, \dots, y_m)$. A linear transformation $A \in L(\mathbb{R}^{n+m}, \mathbb{R}^m)$ can then be written as $A = [A_x \ A_y]$ so that $A(x, y) = A_x x + A_y y$, where $A_x \in L(\mathbb{R}^n, \mathbb{R}^m)$ and $A_y \in L(\mathbb{R}^m)$.

Proposition 8.5.5. *Let $A = [A_x \ A_y] \in L(\mathbb{R}^{n+m}, \mathbb{R}^m)$ and suppose A_y is invertible. If $B = -(A_y)^{-1}A_x$, then*

$$0 = A(x, Bx) = A_x x + A_y Bx.$$

Furthermore, $y = Bx$ is the unique $y \in \mathbb{R}^m$ such that $A(x, y) = 0$.

The proof is immediate: We solve and obtain $y = Bx$. Another way to solve is to “complete the basis,” that is, add rows to the matrix until we have an invertible matrix. In this case, we construct a mapping $(x, y) \mapsto (x, A_x x + A_y y)$, and find that this operator in $L(\mathbb{R}^{n+m})$ is invertible, and the map B can be read off from the inverse. Let us show that the same can be done for C^1 functions.

Theorem 8.5.6 (Implicit function theorem). *Let $U \subset \mathbb{R}^{n+m}$ be an open set and let $f: U \rightarrow \mathbb{R}^m$ be a $C^1(U)$ mapping. Let $(p, q) \in U$ be a point such that $f(p, q) = 0$ and such that*

$$\frac{\partial(f_1, \dots, f_m)}{\partial(y_1, \dots, y_m)}(p, q) \neq 0.$$

Then there exists an open set $W \subset \mathbb{R}^n$ with $p \in W$, an open set $W' \subset \mathbb{R}^m$ with $q \in W'$, with $W \times W' \subset U$, and a $C^1(W)$ mapping $g: W \rightarrow W'$, with $g(p) = q$, and for all $x \in W$, the point $g(x)$ is the unique point in W' such that

$$f(x, g(x)) = 0.$$

Furthermore, if $[A_x \ A_y] = f'(p, q)$, then

$$g'(p) = -(A_y)^{-1}A_x.$$

The condition $\frac{\partial(f_1, \dots, f_m)}{\partial(y_1, \dots, y_m)}(p, q) = \det(A_y) \neq 0$ simply means that A_y is invertible. If $n = m = 1$, the condition becomes $\frac{\partial f}{\partial y}(p, q) \neq 0$, W and W' are open intervals. See [Figure 8.12](#).

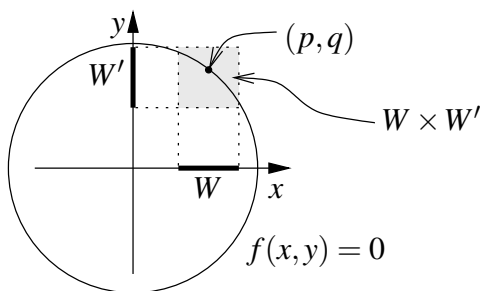

Figure 8.12: Implicit function theorem for $f(x, y) = x^2 + y^2 - 1$ in $U = \mathbb{R}^2$ and (p, q) in the first quadrant.

Proof. Define $F: U \rightarrow \mathbb{R}^{n+m}$ by $F(x, y) := (x, f(x, y))$. It is clear that F is C^1 , and we want to show that the derivative at (p, q) is invertible.

Let us compute the derivative. The quotient

$$\frac{\|f(p+h, q+k) - f(p, q) - A_x h - A_y k\|}{\|(h, k)\|}$$

goes to zero as $\|(h, k)\| = \sqrt{\|h\|^2 + \|k\|^2}$ goes to zero. But then so does

$$\begin{aligned} \frac{\|F(p+h, q+k) - F(p, q) - (h, A_x h + A_y k)\|}{\|(h, k)\|} &= \frac{\|(h, f(p+h, q+k) - f(p, q)) - (h, A_x h + A_y k)\|}{\|(h, k)\|} \\ &= \frac{\|f(p+h, q+k) - f(p, q) - A_x h - A_y k\|}{\|(h, k)\|}. \end{aligned}$$

So the derivative of F at (p, q) takes (h, k) to $(h, A_x h + A_y k)$. In block matrix form it is $\begin{bmatrix} I & 0 \\ A_x & A_y \end{bmatrix}$. If $(h, A_x h + A_y k) = (0, 0)$, then $h = 0$, and so $A_y k = 0$. As A_y is one-to-one, $k = 0$. Thus $F'(p, q)$ is one-to-one or in other words invertible, and we apply the inverse function theorem.

That is, there exists an open set $V \subset \mathbb{R}^{n+m}$ with $F(p, q) = (p, 0) \in V$, and a C^1 mapping $G: V \rightarrow \mathbb{R}^{n+m}$, such that $F(G(x, s)) = (x, s)$ for all $(x, s) \in V$, G is one-to-one, and $G(V)$ is open. Write $G = (G_1, G_2)$ (the first n and the second m components of G). Then

$$F(G_1(x, s), G_2(x, s)) = \left(G_1(x, s), f(G_1(x, s), G_2(x, s)) \right) = (x, s).$$

So $x = G_1(x, s)$ and $f(G_1(x, s), G_2(x, s)) = f(x, G_2(x, s)) = s$. Plugging in $s = 0$, we obtain

$$f(x, G_2(x, 0)) = 0.$$

As the set $G(V)$ is open and $(p, q) \in G(V)$, there exist some open sets \tilde{W} and W' such that $\tilde{W} \times W' \subset G(V)$ with $p \in \tilde{W}$ and $q \in W'$. Take $W := \{x \in \tilde{W} : G_2(x, 0) \in W'\}$. The function that takes x to $G_2(x, 0)$ is continuous and therefore W is open. Define $g: W \rightarrow \mathbb{R}^m$ by $g(x) := G_2(x, 0)$, which is the g in the theorem. The fact that $g(x)$ is the unique point in W' follows because $W \times W' \subset G(V)$ and G is one-to-one.

Next differentiate

$$x \mapsto f(x, g(x)),$$

at p , which is the zero map, so its derivative is zero. Using the chain rule,

$$0 = A(h, g'(p)h) = A_x h + A_y g'(p)h,$$

for all $h \in \mathbb{R}^n$, and we obtain the desired derivative for g . □

In other words, in the context of the theorem we have m equations in $n + m$ unknowns:

$$\begin{aligned} f_1(x_1, \dots, x_n, y_1, \dots, y_m) &= 0, \\ f_2(x_1, \dots, x_n, y_1, \dots, y_m) &= 0, \\ &\vdots \\ f_m(x_1, \dots, x_n, y_1, \dots, y_m) &= 0. \end{aligned}$$

And the condition guaranteeing a solution is that this is a C^1 mapping (that all the components are C^1 , or in other words all the partial derivatives exist and are continuous), and the matrix

$$\begin{bmatrix} \frac{\partial f_1}{\partial y_1} & \frac{\partial f_1}{\partial y_2} & \cdots & \frac{\partial f_1}{\partial y_m} \\ \frac{\partial f_2}{\partial y_1} & \frac{\partial f_2}{\partial y_2} & \cdots & \frac{\partial f_2}{\partial y_m} \\ \vdots & \vdots & \ddots & \vdots \\ \frac{\partial f_m}{\partial y_1} & \frac{\partial f_m}{\partial y_2} & \cdots & \frac{\partial f_m}{\partial y_m} \end{bmatrix}$$

is invertible at (p, q) .

Example 8.5.7: Consider the set given by $x^2 + y^2 - (z+1)^3 = -1$ and $e^x + e^y + e^z = 3$ near the point $(0,0,0)$. It is the zero set of the function

$$f(x,y,z) = (x^2 + y^2 - (z+1)^3 + 1, e^x + e^y + e^z - 3),$$

whose derivative is

$$f' = \begin{bmatrix} 2x & 2y & -3(z+1)^2 \\ e^x & e^y & e^z \end{bmatrix}.$$

The matrix

$$\begin{bmatrix} 2(0) & -3(0+1)^2 \\ e^0 & e^0 \end{bmatrix} = \begin{bmatrix} 0 & -3 \\ 1 & 1 \end{bmatrix}$$

is invertible. Hence near $(0,0,0)$ we can solve for y and z as C^1 functions of x such that for x near 0, we have

$$x^2 + y(x)^2 - (z(x) + 1)^3 = -1, \quad e^x + e^{y(x)} + e^{z(x)} = 3.$$

The theorem does not tell us how to find $y(x)$ and $z(x)$ explicitly, it just tells us they exist. In other words, near the origin the set of solutions is a smooth curve in \mathbb{R}^3 that goes through the origin.

An interesting observation from the proof is that we solved the equation $f(x, g(x)) = s$ for all s in some neighborhood of 0, not just $s = 0$.

Remark 8.5.8. There are versions of the theorem for arbitrarily many derivatives. If f has k continuous derivatives, then the solution also has k continuous derivatives. See also the next section.

8.5.2 Exercises

Exercise 8.5.1: Let $C := \{(x,y) \in \mathbb{R}^2 : x^2 + y^2 = 1\}$.

- Solve for y in terms of x near $(0,1)$ (that is, find the function g from the implicit function theorem for a neighborhood of the point $(p,q) = (0,1)$).
- Solve for y in terms of x near $(0,-1)$.
- Solve for x in terms of y near $(-1,0)$.

Exercise 8.5.2: Define $f: \mathbb{R}^2 \rightarrow \mathbb{R}^2$ by $f(x,y) := (x, y + h(x))$ for some continuously differentiable function h of one variable.

- Show that f is one-to-one and onto.
- Compute f' .
- Show that f' is invertible at all points, and compute its inverse.

Exercise 8.5.3: Define $f: \mathbb{R}^2 \rightarrow \mathbb{R}^2 \setminus \{(0,0)\}$ by $f(x,y) := (e^x \cos(y), e^x \sin(y))$.

- Show that f is onto.
- Show that f' is invertible at all points.
- Show that f is not one-to-one, in fact for every $(a,b) \in \mathbb{R}^2 \setminus \{(0,0)\}$, there exist infinitely many different points $(x,y) \in \mathbb{R}^2$ such that $f(x,y) = (a,b)$.

Therefore, invertible derivative at every point does not mean that f is invertible globally.

Note: Feel free to use what you know about sine and cosine from calculus.

Exercise 8.5.4: Find a map $f: \mathbb{R}^n \rightarrow \mathbb{R}^n$ that is one-to-one, onto, continuously differentiable, but $f'(0) = 0$. Hint: Generalize $f(x) = x^3$ from one to n dimensions.

Exercise 8.5.5: Consider $z^2 + xz + y = 0$ in \mathbb{R}^3 . Find an equation $D(x, y) = 0$, such that if $D(x_0, y_0) \neq 0$ and $z^2 + x_0z + y_0 = 0$ for some $z \in \mathbb{R}$, then for points near (x_0, y_0) there exist exactly two distinct continuously differentiable functions $r_1(x, y)$ and $r_2(x, y)$ such that $z = r_1(x, y)$ and $z = r_2(x, y)$ solve $z^2 + xz + y = 0$. Do you recognize the expression D from algebra?

Exercise 8.5.6: Suppose $f: (a, b) \rightarrow \mathbb{R}^2$ is continuously differentiable and the first component (the x component) of $\nabla f(t)$ is not equal to 0 for all $t \in (a, b)$. Prove that there exists an interval (c, d) and a continuously differentiable function $g: (c, d) \rightarrow \mathbb{R}$ such that $(x, y) \in f((a, b))$ if and only if $x \in (c, d)$ and $y = g(x)$. In other words, the set $f((a, b))$ is a graph of g .

Exercise 8.5.7: Define $f: \mathbb{R}^2 \rightarrow \mathbb{R}^2$

$$f(x, y) := \begin{cases} (x^2 \sin(1/x) + x/2, y) & \text{if } x \neq 0, \\ (0, y) & \text{if } x = 0. \end{cases}$$

- Show that f is differentiable everywhere.
- Show that $f'(0, 0)$ is invertible.
- Show that f is not one-to-one in every neighborhood of the origin (it is not locally invertible, that is, the inverse function theorem does not work).
- Show that f is not continuously differentiable.

Note: Feel free to use what you know about sine and cosine from calculus.

Exercise 8.5.8 (Polar coordinates): Define a mapping $F(r, \theta) := (r \cos(\theta), r \sin(\theta))$.

- Show that F is continuously differentiable (for all $(r, \theta) \in \mathbb{R}^2$).
- Compute $F'(0, \theta)$ for all θ .
- Show that if $r \neq 0$, then $F'(r, \theta)$ is invertible, therefore an inverse of F exists locally as long as $r \neq 0$.
- Show that $F: \mathbb{R}^2 \rightarrow \mathbb{R}^2$ is onto, and for each point $(x, y) \in \mathbb{R}^2$, the set $F^{-1}(x, y)$ is infinite.
- Show that $F: \mathbb{R}^2 \rightarrow \mathbb{R}^2$ is an open map, despite not satisfying the condition of the inverse function theorem.
- Show that $F|_{(0, \infty) \times [0, 2\pi)}$ is one-to-one and onto $\mathbb{R}^2 \setminus \{(0, 0)\}$.

Note: Feel free to use what you know about sine and cosine from calculus.

Exercise 8.5.9: Let $H := \{(x, y) \in \mathbb{R}^2 : y > 0\}$, and for $(x, y) \in H$ define

$$F(x, y) := \left(\frac{x^2 + y^2 - 1}{x^2 + 2y + y^2 + 1}, \frac{-2x}{x^2 + 2y + y^2 + 1} \right).$$

Prove that F is a bijective mapping from H to $B(0, 1)$, it is continuously differentiable on H , and its inverse is also continuously differentiable.

Exercise 8.5.10: Suppose $U \subset \mathbb{R}^2$ is open and $f: U \rightarrow \mathbb{R}$ is a C^1 function such that $\nabla f(x, y) \neq 0$ for all $(x, y) \in U$. Show that every level set is a C^1 smooth curve. That is, for every $(x, y) \in U$, there exists a C^1 function $\gamma: (-\delta, \delta) \rightarrow \mathbb{R}^2$ with $\gamma'(0) \neq 0$ such that $f(\gamma(t))$ is constant for all $t \in (-\delta, \delta)$.

Exercise 8.5.11: Suppose $U \subset \mathbb{R}^2$ is open and $f: U \rightarrow \mathbb{R}$ is a C^1 function such that $\nabla f(x,y) \neq 0$ for all $(x,y) \in U$. Show that for every (x,y) there exists a neighborhood V of (x,y) an open set $W \subset \mathbb{R}^2$, a bijective C^1 function with a C^1 inverse $g: W \rightarrow V$ such that the level sets of $f \circ g$ are horizontal lines in W , that is, the set given by $(f \circ g)(s,t) = c$ for a constant c is a set of the form $\{(s,t_0) \in \mathbb{R}^2 : s \in \mathbb{R}, (s,t_0) \in W\}$, where t_0 is fixed. That is, the level curves can be locally “straightened.”

8.6 Higher order derivatives

Note: less than 1 lecture, partly depends on the optional §4.3 of volume I

Let $U \subset \mathbb{R}^n$ be an open set and $f: U \rightarrow \mathbb{R}$ a function. Denote by $x = (x_1, x_2, \dots, x_n) \in \mathbb{R}^n$ our coordinates. Suppose $\frac{\partial f}{\partial x_j}$ exists everywhere in U , then it is also a function $\frac{\partial f}{\partial x_j}: U \rightarrow \mathbb{R}$. Therefore, it makes sense to talk about its partial derivatives. We denote the partial derivative of $\frac{\partial f}{\partial x_j}$ with respect to x_k by

$$\frac{\partial^2 f}{\partial x_k \partial x_j} := \frac{\partial \left(\frac{\partial f}{\partial x_j} \right)}{\partial x_k}.$$

If $k = j$, then we write $\frac{\partial^2 f}{\partial x_j^2}$ for simplicity.

We define higher order derivatives inductively. Suppose j_1, j_2, \dots, j_ℓ are integers between 1 and n , and suppose

$$\frac{\partial^{\ell-1} f}{\partial x_{j_{\ell-1}} \partial x_{j_{\ell-2}} \cdots \partial x_{j_1}}$$

exists and is differentiable in the variable x_{j_ℓ} , then the partial derivative with respect to that variable is denoted by

$$\frac{\partial^\ell f}{\partial x_{j_\ell} \partial x_{j_{\ell-1}} \cdots \partial x_{j_1}} := \frac{\partial \left(\frac{\partial^{\ell-1} f}{\partial x_{j_{\ell-1}} \partial x_{j_{\ell-2}} \cdots \partial x_{j_1}} \right)}{\partial x_{j_\ell}}.$$

Such a derivative is called a *partial derivative of order ℓ* .

Sometimes the notation $f_{x_j x_k}$ is used for $\frac{\partial^2 f}{\partial x_k \partial x_j}$. This notation swaps the order in which we write the derivatives, which may be important.

Definition 8.6.1. Suppose $U \subset \mathbb{R}^n$ is an open set and $f: U \rightarrow \mathbb{R}$ is a function. We say f is *k -times continuously differentiable function*, or a C^k function, if all partial derivatives of all orders up to and including order k exist and are continuous.

So a continuously differentiable, or C^1 , function is one where all partial derivatives exist and are continuous, which agrees with our previous definition due to [Proposition 8.4.6](#). We could have required only that the k th order partial derivatives exist and are continuous, as the existence of lower order derivatives is clearly necessary to even define k th order partial derivatives, and these lower order derivatives are continuous as they are differentiable functions.

When the partial derivatives are continuous, we can swap their order.

Proposition 8.6.2. Suppose $U \subset \mathbb{R}^n$ is open and $f: U \rightarrow \mathbb{R}$ is a C^2 function, and j and k are two integers from 1 to n . Then

$$\frac{\partial^2 f}{\partial x_k \partial x_j} = \frac{\partial^2 f}{\partial x_j \partial x_k}.$$

Proof. Fix a $p \in U$, and let e_j and e_k be the standard basis vectors. Pick two positive numbers s and t small enough so that $p + s_0 e_j + t_0 e_k \in U$ whenever $0 < s_0 \leq s$ and $0 < t_0 \leq t$. This can be done as U is open and so contains a small open ball (or a box if you wish) around p .

Use the mean value theorem on the function

$$\tau \mapsto f(p + se_j + \tau e_k) - f(p + \tau e_k),$$

on the interval $[0, t]$ to find a $t_0 \in (0, t)$ such that

$$\frac{f(p + se_j + te_k) - f(p + te_k) - f(p + se_j) + f(p)}{t} = \frac{\partial f}{\partial x_k}(p + se_j + t_0 e_k) - \frac{\partial f}{\partial x_k}(p + t_0 e_k).$$

Next there exists a number $s_0 \in (0, s)$

$$\frac{\frac{\partial f}{\partial x_k}(p + se_j + t_0 e_k) - \frac{\partial f}{\partial x_k}(p + t_0 e_k)}{s} = \frac{\partial^2 f}{\partial x_j \partial x_k}(p + s_0 e_j + t_0 e_k).$$

In other words,

$$g(s, t) := \frac{f(p + se_j + te_k) - f(p + te_k) - f(p + se_j) + f(p)}{st} = \frac{\partial^2 f}{\partial x_j \partial x_k}(p + s_0 e_j + t_0 e_k).$$

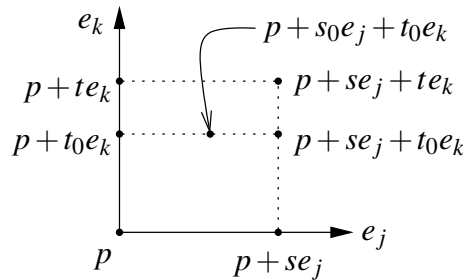

Figure 8.13: Using the mean value theorem to estimate a second order partial derivative by a certain difference quotient.

See Figure 8.13. The s_0 and t_0 depend on s and t , but $0 < s_0 < s$ and $0 < t_0 < t$. Denote by \mathbb{R}_+^2 the set of (s, t) where $s > 0$ and $t > 0$. The set \mathbb{R}_+^2 is the domain of g , and $(0, 0)$ is a cluster point of \mathbb{R}_+^2 . As $(s, t) \in \mathbb{R}_+^2$ goes to $(0, 0)$, $(s_0, t_0) \in \mathbb{R}_+^2$ also goes to $(0, 0)$. By continuity of the second partial derivatives,

$$\lim_{(s,t) \rightarrow (0,0)} g(s, t) = \frac{\partial^2 f}{\partial x_j \partial x_k}(p).$$

Now reverse the ordering. Start with the function $\sigma \mapsto f(p + \sigma e_j + te_k) - f(p + \sigma e_j)$ find an $s_1 \in (0, s)$ such that

$$\frac{f(p + te_k + se_j) - f(p + se_j) - f(p + te_k) + f(p)}{s} = \frac{\partial f}{\partial x_j}(p + te_k + s_1 e_j) - \frac{\partial f}{\partial x_j}(p + s_1 e_j).$$

Find a $t_1 \in (0, t)$ such that

$$\frac{\frac{\partial f}{\partial x_j}(p + te_k + s_1 e_j) - \frac{\partial f}{\partial x_j}(p + s_1 e_j)}{t} = \frac{\partial^2 f}{\partial x_k \partial x_j}(p + t_1 e_k + s_1 e_j).$$

So $g(s, t) = \frac{\partial^2 f}{\partial x_k \partial x_j}(p + t_1 e_k + s_1 e_j)$ for the same g as above. And as before

$$\lim_{(s,t) \rightarrow (0,0)} g(s, t) = \frac{\partial^2 f}{\partial x_k \partial x_j}(p).$$

Therefore the two partial derivatives are equal. \square

The proposition does not hold if the derivatives are not continuous. See the [Exercise 8.6.2](#). Notice also that we did not really need a C^2 function, we only needed the two second order partial derivatives involved to be continuous functions.

8.6.1 Exercises

Exercise 8.6.1: Suppose $f: U \rightarrow \mathbb{R}$ is a C^2 function for some open $U \subset \mathbb{R}^n$ and $p \in U$. Use the proof of [Proposition 8.6.2](#) to find an expression in terms of just the values of f (analogue of the difference quotient for the first derivative), whose limit is $\frac{\partial^2 f}{\partial x_j \partial x_k}(p)$.

Exercise 8.6.2: Define

$$f(x, y) := \begin{cases} \frac{xy(x^2 - y^2)}{x^2 + y^2} & \text{if } (x, y) \neq (0, 0), \\ 0 & \text{if } (x, y) = (0, 0). \end{cases}$$

Show that

- a) The first order partial derivatives exist and are continuous.
 b) The partial derivatives $\frac{\partial^2 f}{\partial x \partial y}$ and $\frac{\partial^2 f}{\partial y \partial x}$ exist, but are not continuous at the origin, and $\frac{\partial^2 f}{\partial x \partial y}(0, 0) \neq \frac{\partial^2 f}{\partial y \partial x}(0, 0)$.

Exercise 8.6.3: Suppose $f: U \rightarrow \mathbb{R}$ is a C^k function for some open $U \subset \mathbb{R}^n$ and $p \in U$. Suppose j_1, j_2, \dots, j_k are integers between 1 and n , and suppose $\sigma = (\sigma_1, \sigma_2, \dots, \sigma_k)$ is a permutation of $(1, 2, \dots, k)$. Prove

$$\frac{\partial^k f}{\partial x_{j_k} \partial x_{j_{k-1}} \cdots \partial x_{j_1}}(p) = \frac{\partial^k f}{\partial x_{j_{\sigma_k}} \partial x_{j_{\sigma_{k-1}}} \cdots \partial x_{j_{\sigma_1}}}(p).$$

Exercise 8.6.4: Suppose $\varphi: \mathbb{R}^2 \rightarrow \mathbb{R}$ is a C^k function such that $\varphi(0, \theta) = \varphi(0, \psi)$ for all $\theta, \psi \in \mathbb{R}$ and $\varphi(r, \theta) = \varphi(r, \theta + 2\pi)$ for all $r, \theta \in \mathbb{R}$. Let $F(r, \theta) := (r \cos(\theta), r \sin(\theta))$ from [Exercise 8.5.8](#). Show that a function $g: \mathbb{R}^2 \rightarrow \mathbb{R}$, given $g(x, y) := \varphi(F^{-1}(x, y))$ is well-defined (notice that $F^{-1}(x, y)$ can only be defined locally), and when restricted to $\mathbb{R}^2 \setminus \{0\}$ it is a C^k function.

Note: Feel free to use what you know about sine and cosine from calculus.

Exercise 8.6.5: Suppose $f: \mathbb{R}^2 \rightarrow \mathbb{R}$ is a C^2 function. For all $(x, y) \in \mathbb{R}^2$, compute

$$\lim_{t \rightarrow 0} \frac{f(x+t, y) + f(x-t, y) + f(x, y+t) + f(x, y-t) - 4f(x, y)}{t^2}$$

in terms of the partial derivatives of f .

Exercise 8.6.6: Suppose $f: \mathbb{R}^2 \rightarrow \mathbb{R}$ is a function such that all first and second order partial derivatives exist. Furthermore, suppose that all second order partial derivatives are bounded functions. Prove that f is continuously differentiable.

Exercise 8.6.7: Follow the strategy below to prove the following simple version of the second derivative test for functions defined on \mathbb{R}^2 (using (x, y) as coordinates): Suppose $f: \mathbb{R}^2 \rightarrow \mathbb{R}$ is a twice continuously differentiable function with a critical point at the origin, $f'(0, 0) = 0$. If

$$\frac{\partial^2 f}{\partial x^2}(0, 0) > 0 \quad \text{and} \quad \frac{\partial^2 f}{\partial x^2}(0, 0) \frac{\partial^2 f}{\partial y^2}(0, 0) - \left(\frac{\partial^2 f}{\partial x \partial y}(0, 0) \right)^2 > 0,$$

then f has a (strict) local minimum at $(0, 0)$. Use the following technique: First suppose without loss of generality that $f(0, 0) = 0$. Then prove:

- a) There exists an $A \in L(\mathbb{R}^2)$ such that $g = f \circ A$ is such that $\frac{\partial^2 g}{\partial x \partial y}(0, 0) = 0$, and $\frac{\partial^2 g}{\partial x^2}(0, 0) = \frac{\partial^2 g}{\partial y^2}(0, 0) = 1$.
- b) For every $\varepsilon > 0$, there exists a $\delta > 0$ such that $|g(x, y) - x^2 - y^2| < \varepsilon(x^2 + y^2)$ for all $(x, y) \in B((0, 0), \delta)$.
Hint: You can use Taylor's theorem in one variable.
- c) This means that g , and therefore f , has a strict local minimum at $(0, 0)$.

Note: You must avoid the temptation to just apply the one variable second derivative test along lines through the origin, see [Exercise 8.3.11](#).

Chapter 9

One-dimensional Integrals in Several Variables

9.1 Differentiation under the integral

Note: less than 1 lecture

Let $f(x, y)$ be a function of two variables and define

$$g(y) := \int_a^b f(x, y) dx.$$

If f is continuous on the compact rectangle $[a, b] \times [c, d]$, then Proposition 7.5.12 from volume I says that g is continuous on $[c, d]$.

Suppose f is differentiable in y . The main question we want to ask is when can we “differentiate under the integral,” that is, when is it true that g is differentiable and its derivative is

$$g'(y) \stackrel{?}{=} \int_a^b \frac{\partial f}{\partial y}(x, y) dx.$$

Differentiation is a limit and therefore we are really asking when do the two limiting operations of integration and differentiation commute. This is not always possible and some extra hypothesis is necessary. The first question we would face is the integrability of $\frac{\partial f}{\partial y}$, but the formula above can fail even if $\frac{\partial f}{\partial y}$ is integrable as a function of x for every fixed y .

We prove a simple, but perhaps the most useful version of this kind of result.

Theorem 9.1.1 (Leibniz integral rule). *Suppose $f : [a, b] \times [c, d] \rightarrow \mathbb{R}$ is a continuous function, such that $\frac{\partial f}{\partial y}$ exists for all $(x, y) \in [a, b] \times [c, d]$ and is continuous. Define*

$$g(y) := \int_a^b f(x, y) dx.$$

Then $g : [c, d] \rightarrow \mathbb{R}$ is continuously differentiable and

$$g'(y) = \int_a^b \frac{\partial f}{\partial y}(x, y) dx.$$

The hypotheses on f and $\frac{\partial f}{\partial y}$ can be weakened, see e.g. [Exercise 9.1.8](#), but not dropped outright. The main point in the proof requires that $\frac{\partial f}{\partial y}$ exists and is continuous for all x up to the endpoints, but we only need a small interval in the y direction. In applications, we often make $[c, d]$ a small interval around the point where we need to differentiate.

Proof. Fix $y \in [c, d]$ and let $\varepsilon > 0$ be given. As $\frac{\partial f}{\partial y}$ is continuous on $[a, b] \times [c, d]$ it is uniformly continuous. In particular, there exists $\delta > 0$ such that whenever $y_1 \in [c, d]$ with $|y_1 - y| < \delta$ and all $x \in [a, b]$, we have

$$\left| \frac{\partial f}{\partial y}(x, y_1) - \frac{\partial f}{\partial y}(x, y) \right| < \varepsilon.$$

Suppose h is such that $y + h \in [c, d]$ and $|h| < \delta$. Fix x for a moment and apply the mean value theorem to find a y_1 between y and $y + h$ such that

$$\frac{f(x, y + h) - f(x, y)}{h} = \frac{\partial f}{\partial y}(x, y_1).$$

As $|y_1 - y| \leq |h| < \delta$,

$$\left| \frac{f(x, y + h) - f(x, y)}{h} - \frac{\partial f}{\partial y}(x, y) \right| = \left| \frac{\partial f}{\partial y}(x, y_1) - \frac{\partial f}{\partial y}(x, y) \right| < \varepsilon.$$

This argument worked for every $x \in [a, b]$. Therefore, as a function of x

$$x \mapsto \frac{f(x, y + h) - f(x, y)}{h} \quad \text{converges uniformly to} \quad x \mapsto \frac{\partial f}{\partial y}(x, y) \quad \text{as } h \rightarrow 0.$$

We defined uniform convergence for sequences although the idea is the same. You may replace h with a sequence of nonzero numbers $\{h_n\}$ converging to 0 such that $y + h_n \in [c, d]$ and let $n \rightarrow \infty$.

Consider the difference quotient of g ,

$$\frac{g(y + h) - g(y)}{h} = \frac{\int_a^b f(x, y + h) dx - \int_a^b f(x, y) dx}{h} = \int_a^b \frac{f(x, y + h) - f(x, y)}{h} dx.$$

Uniform convergence implies the limit can be taken underneath the integral. So

$$\lim_{h \rightarrow 0} \frac{g(y + h) - g(y)}{h} = \int_a^b \lim_{h \rightarrow 0} \frac{f(x, y + h) - f(x, y)}{h} dx = \int_a^b \frac{\partial f}{\partial y}(x, y) dx.$$

Then g' is continuous on $[c, d]$ by Proposition 7.5.12 from volume I mentioned above. \square

Example 9.1.2: Let

$$f(y) = \int_0^1 \sin(x^2 - y^2) dx.$$

Then

$$f'(y) = \int_0^1 -2y \cos(x^2 - y^2) dx.$$

Example 9.1.3: Consider

$$\int_0^1 \frac{x-1}{\ln(x)} dx.$$

The function under the integral extends to be continuous on $[0, 1]$, and hence the integral exists, see [Exercise 9.1.1](#). Trouble is finding it. We introduce a parameter y and define a function:

$$g(y) := \int_0^1 \frac{x^y - 1}{\ln(x)} dx.$$

The function $\frac{x^y - 1}{\ln(x)}$ also extends to a continuous function of x and y for $(x, y) \in [0, 1] \times [0, 1]$ (also part of the exercise). See [Figure 9.1](#).

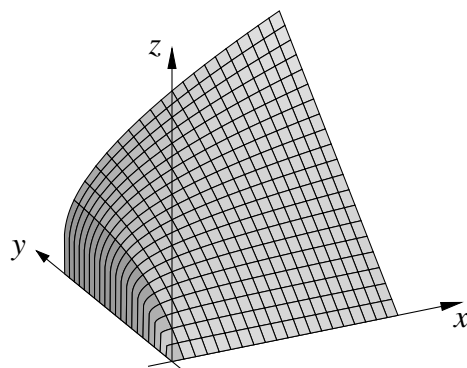

Figure 9.1: The graph $z = \frac{x^y - 1}{\ln(x)}$ on $[0, 1] \times [0, 1]$.

Hence, g is a continuous function on $[0, 1]$ and $g(0) = 0$. For every $\varepsilon > 0$, the y derivative of the integrand, x^y , is continuous on $[0, 1] \times [\varepsilon, 1]$. Therefore, for $y > 0$, we may differentiate under the integral sign,

$$g'(y) = \int_0^1 \frac{\ln(x)x^y}{\ln(x)} dx = \int_0^1 x^y dx = \frac{1}{y+1}.$$

We need to figure out $g(1)$ given that $g'(y) = \frac{1}{y+1}$ and $g(0) = 0$. Elementary calculus says that $g(1) = \int_0^1 g'(y) dy = \ln(2)$. Thus,

$$\int_0^1 \frac{x-1}{\ln(x)} dx = \ln(2).$$

9.1.1 Exercises

Exercise 9.1.1: Prove the two statements that were asserted in [Example 9.1.3](#):

- Prove $\frac{x-1}{\ln(x)}$ extends to a continuous function of $[0, 1]$. That is, there exists a continuous function on $[0, 1]$ that equals $\frac{x-1}{\ln(x)}$ on $(0, 1)$.
- Prove $\frac{x^y - 1}{\ln(x)}$ extends to a continuous function on $[0, 1] \times [0, 1]$.

Exercise 9.1.2: Suppose $h: \mathbb{R} \rightarrow \mathbb{R}$ is continuous and $g: \mathbb{R} \rightarrow \mathbb{R}$ is continuously differentiable and compactly supported. That is, there exists some $M > 0$, such that $g(x) = 0$ whenever $|x| \geq M$. Define

$$f(x) := \int_{-\infty}^{\infty} h(y)g(x-y) dy.$$

Show that f is differentiable.

Exercise 9.1.3: Suppose $f: \mathbb{R} \rightarrow \mathbb{R}$ is infinitely differentiable (all derivatives exist) such that $f(0) = 0$. Then show that there exists an infinitely differentiable function $g: \mathbb{R} \rightarrow \mathbb{R}$ such that $f(x) = xg(x)$. Show also that if $f'(0) \neq 0$, then $g(0) \neq 0$.

Hint: First write $f(x) = \int_0^x f'(s) ds$ and then rewrite the integral to go from 0 to 1.

Exercise 9.1.4: Compute $\int_0^1 e^{tx} dx$. Derive the formula for $\int_0^1 x^n e^x dx$ not using integration by parts, but by differentiation underneath the integral.

Exercise 9.1.5: Let $U \subset \mathbb{R}^n$ be an open set and suppose $f(x, y_1, y_2, \dots, y_n)$ is a continuous function defined on $[0, 1] \times U \subset \mathbb{R}^{n+1}$. Suppose $\frac{\partial f}{\partial y_1}, \frac{\partial f}{\partial y_2}, \dots, \frac{\partial f}{\partial y_n}$ exist and are continuous on $[0, 1] \times U$. Then prove that $F: U \rightarrow \mathbb{R}$ defined by

$$F(y_1, y_2, \dots, y_n) := \int_0^1 f(x, y_1, y_2, \dots, y_n) dx$$

is continuously differentiable.

Exercise 9.1.6: Work out the following counterexample: Let

$$f(x, y) := \begin{cases} \frac{xy^3}{(x^2+y^2)^2} & \text{if } x \neq 0 \text{ or } y \neq 0, \\ 0 & \text{if } x = 0 \text{ and } y = 0. \end{cases}$$

a) Prove that for every fixed y , the function $x \mapsto f(x, y)$ is Riemann integrable on $[0, 1]$, and

$$g(y) := \int_0^1 f(x, y) dx = \frac{y}{2y^2 + 2}.$$

Therefore, $g'(y)$ exists and its derivative is the continuous function

$$g'(y) = \frac{d}{dy} \int_0^1 f(x, y) dx = \frac{1-y^2}{2(y^2+1)^2}.$$

b) Prove $\frac{\partial f}{\partial y}$ exists at all x and y and compute it.

c) Show that for all y

$$\int_0^1 \frac{\partial f}{\partial y}(x, y) dx$$

exists, but

$$g'(0) \neq \int_0^1 \frac{\partial f}{\partial y}(x, 0) dx.$$

Exercise 9.1.7: Work out the following counterexample: Let

$$f(x,y) := \begin{cases} x \sin\left(\frac{y}{x^2+y^2}\right) & \text{if } (x,y) \neq (0,0), \\ 0 & \text{if } (x,y) = (0,0). \end{cases}$$

a) Prove f is continuous on all of \mathbb{R}^2 . Therefore the following function is well-defined for every $y \in \mathbb{R}$:

$$g(y) := \int_0^1 f(x,y) dx.$$

b) Prove $\frac{\partial f}{\partial y}$ exists for all (x,y) , but is not continuous at $(0,0)$.

c) Show that $\int_0^1 \frac{\partial f}{\partial y}(x,0) dx$ does not exist even if we take improper integrals, that is, that the limit

$$\lim_{h \rightarrow 0^+} \int_h^1 \frac{\partial f}{\partial y}(x,0) dx$$

does not exist.

Note: Feel free to use what you know about sine and cosine from calculus.

Exercise 9.1.8: Strengthen the Leibniz integral rule in the following way. Suppose $f: (a,b) \times (c,d) \rightarrow \mathbb{R}$ is a bounded continuous function, such that $\frac{\partial f}{\partial y}$ exists for all $(x,y) \in (a,b) \times (c,d)$ and is continuous and bounded. Define

$$g(y) := \int_a^b f(x,y) dx.$$

Then $g: (c,d) \rightarrow \mathbb{R}$ is continuously differentiable and

$$g'(y) = \int_a^b \frac{\partial f}{\partial y}(x,y) dx.$$

Hint: See also Exercise 7.5.18 and Theorem 6.2.10 from volume I.

9.2 Path integrals

Note: 2–3 lectures

9.2.1 Piecewise smooth paths

Let $\gamma: [a, b] \rightarrow \mathbb{R}^n$ be a function and write $\gamma = (\gamma_1, \gamma_2, \dots, \gamma_n)$. Suppose γ is *continuously differentiable*, that is, it is differentiable and the derivative is continuous. In other words, there exists a continuous function $\gamma': [a, b] \rightarrow \mathbb{R}^n$ such that for every $t \in [a, b]$, we have $\lim_{h \rightarrow 0} \frac{\|\gamma(t+h) - \gamma(t) - \gamma'(t)h\|}{|h|} = 0$. We treat $\gamma'(t)$ either as a linear operator (an $n \times 1$ matrix) or a vector, $\gamma'(t) = (\gamma'_1(t), \gamma'_2(t), \dots, \gamma'_n(t))$. Equivalently, γ_j is a continuously differentiable function on $[a, b]$ for every $j = 1, 2, \dots, n$. By [Exercise 8.2.6](#), the operator norm of the operator $\gamma'(t)$ is equal to the euclidean norm of the corresponding vector, so there is no confusion when writing $\|\gamma'(t)\|$.

Definition 9.2.1. A continuously differentiable function $\gamma: [a, b] \rightarrow \mathbb{R}^n$ is called a *smooth path* or a *continuously differentiable path** if γ is continuously differentiable and $\gamma'(t) \neq 0$ for all $t \in [a, b]$.

The function $\gamma: [a, b] \rightarrow \mathbb{R}^n$ is called a *piecewise smooth path* or a *piecewise continuously differentiable path* if there exist finitely many points $t_0 = a < t_1 < t_2 < \dots < t_k = b$ such that the restriction $\gamma|_{[t_{j-1}, t_j]}$ is smooth path for every $j = 1, 2, \dots, k$.

A path γ is a *closed path* if $\gamma(a) = \gamma(b)$, that is if the path starts and ends in the same point. A path γ is a *simple path* if either 1) γ is a one-to-one function, or 2) $\gamma|_{[a, b]}$ is one-to-one and $\gamma(a) = \gamma(b)$ (γ is a simple closed path).

Example 9.2.2: Let $\gamma: [0, 4] \rightarrow \mathbb{R}^2$ be defined by

$$\gamma(t) := \begin{cases} (t, 0) & \text{if } t \in [0, 1], \\ (1, t-1) & \text{if } t \in (1, 2], \\ (3-t, 1) & \text{if } t \in (2, 3], \\ (0, 4-t) & \text{if } t \in (3, 4]. \end{cases}$$

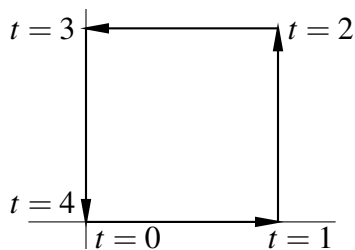

Figure 9.2: The path γ traversing the unit square.

The path γ is the unit square traversed counterclockwise. See [Figure 9.2](#). It is a piecewise smooth path. For example, $\gamma|_{[1,2]}(t) = (1, t-1)$ and so $(\gamma|_{[1,2]})'(t) = (0, 1) \neq 0$. Similarly for the

*The word “smooth” can sometimes mean “infinitely differentiable” in the literature.

other 3 sides. Notice that $(\gamma|_{[1,2]})'(1) = (0, 1)$, $(\gamma|_{[0,1]})'(1) = (1, 0)$, but $\gamma'(1)$ does not exist. At the corners γ is not differentiable. The path γ is a simple closed path, as $\gamma|_{[0,4]}$ is one-to-one and $\gamma(0) = \gamma(4)$.

The definition of a piecewise smooth path as we have given it implies continuity (exercise). For general functions, many authors also allow finitely many discontinuities, when they use the term *piecewise smooth*, and so one may say that we defined a piecewise smooth path to be a *continuous piecewise smooth* function. While one may get by with smooth paths, for computations, the simplest paths to write down are often piecewise smooth.

Generally, we are interested in the direct image $\gamma([a, b])$, rather than the specific parametrization, although that is also important to some degree. When we informally talk about a path or a curve, we often mean the set $\gamma([a, b])$, depending on context.

Example 9.2.3: The condition $\gamma'(t) \neq 0$ means that the image $\gamma([a, b])$ has no “corners” where γ is smooth. Consider

$$\gamma(t) := \begin{cases} (t^2, 0) & \text{if } t < 0, \\ (0, t^2) & \text{if } t \geq 0. \end{cases}$$

See [Figure 9.3](#). It is left for the reader to check that γ is continuously differentiable, yet the image $\gamma(\mathbb{R}) = \{(x, y) \in \mathbb{R}^2 : (x, y) = (s, 0) \text{ or } (x, y) = (0, s) \text{ for some } s \geq 0\}$ has a “corner” at the origin. And that is because $\gamma'(0) = (0, 0)$. More complicated examples with, say, infinitely many corners exist, see the exercises.

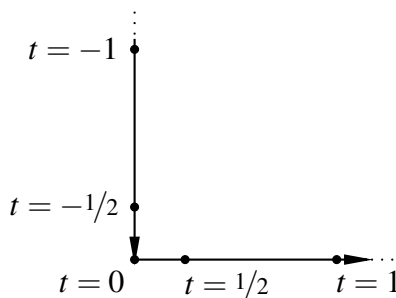

Figure 9.3: Smooth path with zero derivative with a corner. Several values of t are marked with dots.

The condition $\gamma'(t) \neq 0$ even at the endpoints guarantees not only no corners, but also that the path ends nicely, that is, it can extend a little bit past the endpoints. Again, see the exercises.

Example 9.2.4: A graph of a continuously differentiable function $f: [a, b] \rightarrow \mathbb{R}$ is a smooth path. Define $\gamma: [a, b] \rightarrow \mathbb{R}^2$ by

$$\gamma(t) := (t, f(t)).$$

Then $\gamma'(t) = (1, f'(t))$, which is never zero, and $\gamma([a, b])$ is the graph of f .

There are other ways of parametrizing the path. That is, there are different paths with the same image. The function $t \mapsto (1-t)a + tb$, takes the interval $[0, 1]$ to $[a, b]$. Define $\alpha: [0, 1] \rightarrow \mathbb{R}^2$ by

$$\alpha(t) := ((1-t)a + tb, f((1-t)a + tb)).$$

Then $\alpha'(t) = (b-a, (b-a)f'((1-t)a+tb))$, which is never zero. As sets, $\alpha([0, 1]) = \gamma([a, b]) = \{(x, y) \in \mathbb{R}^2 : x \in [a, b] \text{ and } f(x) = y\}$, which is just the graph of f .

The last example leads us to a definition.

Definition 9.2.5. Let $\gamma: [a, b] \rightarrow \mathbb{R}^n$ be a smooth path and $h: [c, d] \rightarrow [a, b]$ a continuously differentiable bijective function such that $h'(t) \neq 0$ for all $t \in [c, d]$. Then the composition $\gamma \circ h$ is called a *smooth reparametrization* of γ .

Let γ be a piecewise smooth path, and h a piecewise smooth bijective function with nonzero one-sided limits of h' . The composition $\gamma \circ h$ is called a *piecewise smooth reparametrization* of γ .

If h is strictly increasing, then h is said to *preserve orientation*. If h does not preserve orientation, then h is said to *reverse orientation*.

A reparametrization is another path for the same set. That is, $(\gamma \circ h)([c, d]) = \gamma([a, b])$.

The conditions on the piecewise smooth h mean that there is some partition $t_0 = c < t_1 < t_2 < \dots < t_k = d$, such that $h|_{[t_{j-1}, t_j]}$ is continuously differentiable and $(h|_{[t_{j-1}, t_j]})'(t) \neq 0$ for all $t \in [t_{j-1}, t_j]$. Since h is bijective, it is either strictly increasing or strictly decreasing. So either $(h|_{[t_{j-1}, t_j]})'(t) > 0$ for all t or $(h|_{[t_{j-1}, t_j]})'(t) < 0$ for all t .

Proposition 9.2.6. If $\gamma: [a, b] \rightarrow \mathbb{R}^n$ is a piecewise smooth path, and $\gamma \circ h: [c, d] \rightarrow \mathbb{R}^n$ is a piecewise smooth reparametrization, then $\gamma \circ h$ is a piecewise smooth path.

Proof. Assume that h preserves orientation, that is, h is strictly increasing. If $h: [c, d] \rightarrow [a, b]$ gives a piecewise smooth reparametrization, then for some partition $r_0 = c < r_1 < r_2 < \dots < r_\ell = d$, the restriction $h|_{[r_{j-1}, r_j]}$ is continuously differentiable with a positive derivative.

Let $t_0 = a < t_1 < t_2 < \dots < t_k = b$ be the partition from the definition of piecewise smooth for γ together with the points $\{h(r_0), h(r_1), h(r_2), \dots, h(r_\ell)\}$. Let $s_j := h^{-1}(t_j)$. Then $s_0 = c < s_1 < s_2 < \dots < s_k = d$ is a partition that includes (is a refinement of) the $\{r_0, r_1, \dots, r_\ell\}$. If $\tau \in [s_{j-1}, s_j]$, then $h(\tau) \in [t_{j-1}, t_j]$ since $h(s_{j-1}) = t_{j-1}$, $h(s_j) = t_j$, and h is strictly increasing. Also $h|_{[s_{j-1}, s_j]}$ is continuously differentiable, and $\gamma|_{[t_{j-1}, t_j]}$ is also continuously differentiable. Then

$$(\gamma \circ h)|_{[s_{j-1}, s_j]}(\tau) = \gamma|_{[t_{j-1}, t_j]}(h|_{[s_{j-1}, s_j]}(\tau)).$$

The function $(\gamma \circ h)|_{[s_{j-1}, s_j]}$ is therefore continuously differentiable and by the chain rule

$$((\gamma \circ h)|_{[s_{j-1}, s_j]})'(\tau) = (\gamma|_{[t_{j-1}, t_j]})'(h(\tau))(h|_{[s_{j-1}, s_j]})'(\tau) \neq 0.$$

Consequently, $\gamma \circ h$ is a piecewise smooth path. Orientation reversing h is left as an exercise. \square

If two paths are simple and their images are the same, it is left as an exercise that there exists a reparametrization. Here is where our assumption that γ' is never zero is important.

9.2.2 Path integral of a one-form

Definition 9.2.7. Let $(x_1, x_2, \dots, x_n) \in \mathbb{R}^n$ be our coordinates. Given n real-valued continuous functions $\omega_1, \omega_2, \dots, \omega_n$ defined on a set $S \subset \mathbb{R}^n$, we define a *one-form* to be an object of the form

$$\omega = \omega_1 dx_1 + \omega_2 dx_2 + \dots + \omega_n dx_n.$$

We could represent ω as a continuous function from S to \mathbb{R}^n , although it is better to think of it as a different object.

Example 9.2.8:

$$\omega(x, y) := \frac{-y}{x^2 + y^2} dx + \frac{x}{x^2 + y^2} dy$$

is a one-form defined on $\mathbb{R}^2 \setminus \{(0, 0)\}$.

Definition 9.2.9. Let $\gamma: [a, b] \rightarrow \mathbb{R}^n$ be a smooth path and let

$$\omega = \omega_1 dx_1 + \omega_2 dx_2 + \cdots + \omega_n dx_n,$$

be a one-form defined on the direct image $\gamma([a, b])$. Write $\gamma = (\gamma_1, \gamma_2, \dots, \gamma_n)$. Define:

$$\begin{aligned} \int_{\gamma} \omega &:= \int_a^b \left(\omega_1(\gamma(t)) \gamma_1'(t) + \omega_2(\gamma(t)) \gamma_2'(t) + \cdots + \omega_n(\gamma(t)) \gamma_n'(t) \right) dt \\ &= \int_a^b \left(\sum_{j=1}^n \omega_j(\gamma(t)) \gamma_j'(t) \right) dt. \end{aligned}$$

To remember the definition note that x_j is $\gamma_j(t)$, so dx_j becomes $\gamma_j'(t) dt$.

If γ is piecewise smooth, take the corresponding partition $t_0 = a < t_1 < t_2 < \cdots < t_k = b$, and assume the partition is minimal in the sense that γ is not differentiable at t_1, t_2, \dots, t_{k-1} . As each $\gamma|_{[t_{j-1}, t_j]}$ is a smooth path, define

$$\int_{\gamma} \omega := \int_{\gamma|_{[t_0, t_1]}} \omega + \int_{\gamma|_{[t_1, t_2]}} \omega + \cdots + \int_{\gamma|_{[t_{k-1}, t_k]}} \omega.$$

The notation makes sense from the formula you remember from calculus, let us state it somewhat informally: If $x_j(t) = \gamma_j(t)$, then $dx_j = \gamma_j'(t) dt$.

Paths can be cut up or concatenated. The proof is a direct application of the additivity of the Riemann integral, and is left as an exercise. The proposition justifies why we defined the integral over a piecewise smooth path in the way we did, and it justifies that we may as well have taken any partition not just the minimal one in the definition.

Proposition 9.2.10. Let $\gamma: [a, c] \rightarrow \mathbb{R}^n$ be a piecewise smooth path, and $b \in (a, c)$. Define the piecewise smooth paths $\alpha := \gamma|_{[a, b]}$ and $\beta := \gamma|_{[b, c]}$. Let ω be a one-form defined on $\gamma([a, c])$. Then

$$\int_{\gamma} \omega = \int_{\alpha} \omega + \int_{\beta} \omega.$$

Example 9.2.11: Let the one-form ω and the path $\gamma: [0, 2\pi] \rightarrow \mathbb{R}^2$ be defined by

$$\omega(x, y) := \frac{-y}{x^2 + y^2} dx + \frac{x}{x^2 + y^2} dy, \quad \gamma(t) := (\cos(t), \sin(t)).$$

Then

$$\begin{aligned} \int_{\gamma} \omega &= \int_0^{2\pi} \left(\frac{-\sin(t)}{(\cos(t))^2 + (\sin(t))^2} (-\sin(t)) + \frac{\cos(t)}{(\cos(t))^2 + (\sin(t))^2} (\cos(t)) \right) dt \\ &= \int_0^{2\pi} 1 dt = 2\pi. \end{aligned}$$

Next, let us parametrize the same curve as $\alpha: [0, 1] \rightarrow \mathbb{R}^2$ defined by $\alpha(t) := (\cos(2\pi t), \sin(2\pi t))$, that is α is a smooth reparametrization of γ . Then

$$\begin{aligned} \int_{\alpha} \omega &= \int_0^1 \left(\frac{-\sin(2\pi t)}{(\cos(2\pi t))^2 + (\sin(2\pi t))^2} (-2\pi \sin(2\pi t)) \right. \\ &\quad \left. + \frac{\cos(2\pi t)}{(\cos(2\pi t))^2 + (\sin(2\pi t))^2} (2\pi \cos(2\pi t)) \right) dt \\ &= \int_0^1 2\pi dt = 2\pi. \end{aligned}$$

Now let us reparametrize with $\beta: [0, 2\pi] \rightarrow \mathbb{R}^2$ as $\beta(t) := (\cos(-t), \sin(-t))$. Then

$$\begin{aligned} \int_{\beta} \omega &= \int_0^{2\pi} \left(\frac{-\sin(-t)}{(\cos(-t))^2 + (\sin(-t))^2} (\sin(-t)) + \frac{\cos(-t)}{(\cos(-t))^2 + (\sin(-t))^2} (-\cos(-t)) \right) dt \\ &= \int_0^{2\pi} (-1) dt = -2\pi. \end{aligned}$$

The path α is an orientation preserving reparametrization of γ , and the integrals are the same. The path β is an orientation reversing reparametrization of γ and the integral is minus the original. See Figure 9.4.

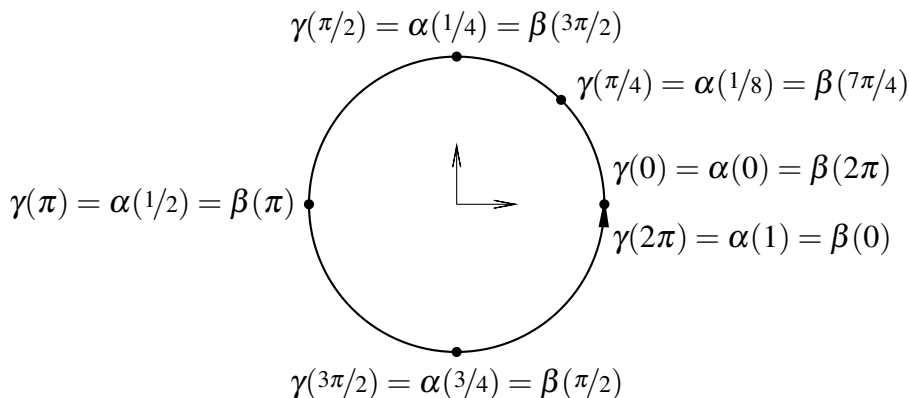

Figure 9.4: A circular path reparametrized in two different ways. The arrow indicates the orientation of γ and α . The path β traverses the circle in the opposite direction.

The previous example is not a fluke. The path integral does not depend on the parametrization of the curve, the only thing that matters is the direction in which the curve is traversed.

Proposition 9.2.12. *Let $\gamma: [a, b] \rightarrow \mathbb{R}^n$ be a piecewise smooth path and $\gamma \circ h: [c, d] \rightarrow \mathbb{R}^n$ a piecewise smooth reparametrization. Suppose ω is a one-form defined on the set $\gamma([a, b])$. Then*

$$\int_{\gamma \circ h} \omega = \begin{cases} \int_{\gamma} \omega & \text{if } h \text{ preserves orientation,} \\ -\int_{\gamma} \omega & \text{if } h \text{ reverses orientation.} \end{cases}$$

Proof. Assume first that γ and h are both smooth. Write $\omega = \omega_1 dx_1 + \omega_2 dx_2 + \cdots + \omega_n dx_n$. Suppose that h is orientation preserving. Use the change of variables formula for the Riemann integral:

$$\begin{aligned} \int_{\gamma} \omega &= \int_a^b \left(\sum_{j=1}^n \omega_j(\gamma(t)) \gamma_j'(t) \right) dt \\ &= \int_c^d \left(\sum_{j=1}^n \omega_j(\gamma(h(\tau))) \gamma_j'(h(\tau)) \right) h'(\tau) d\tau \\ &= \int_c^d \left(\sum_{j=1}^n \omega_j(\gamma(h(\tau))) (\gamma_j \circ h)'(\tau) \right) d\tau = \int_{\gamma \circ h} \omega. \end{aligned}$$

If h is orientation reversing, it swaps the order of the limits on the integral and introduces a minus sign. The details, along with finishing the proof for piecewise smooth paths, is left as [Exercise 9.2.4](#). \square

Due to this proposition (and the exercises), if $\Gamma \subset \mathbb{R}^n$ is the image of a simple piecewise smooth path $\gamma([a, b])$, then as long as we somehow indicate the orientation, that is, the direction in which we traverse the curve, we can write

$$\int_{\Gamma} \omega,$$

without mentioning the specific γ . Furthermore, for a simple closed path, it does not even matter where we start the parametrization. See the exercises.

Recall that *simple* means that γ is one-to-one except perhaps at the endpoints, in particular it is one-to-one when restricted to $[a, b)$. We may relax the condition that the path is simple a little bit. For example, it is enough to suppose that $\gamma: [a, b] \rightarrow \mathbb{R}^n$ is one-to-one except at finitely many points. See [Exercise 9.2.14](#). But we cannot remove the condition completely as is illustrated by the following example.

Example 9.2.13: Suppose $\gamma: [0, 2\pi] \rightarrow \mathbb{R}^2$ is given by $\gamma(t) := (\cos(t), \sin(t))$, and $\beta: [0, 2\pi] \rightarrow \mathbb{R}^2$ is given by $\beta(t) := (\cos(2t), \sin(2t))$. Notice that $\gamma([0, 2\pi]) = \beta([0, 2\pi])$, and we travel around the same curve, the unit circle. But γ goes around the unit circle once in the counter clockwise direction, and β goes around the unit circle twice (in the same direction). See [Figure 9.5](#).

Compute

$$\begin{aligned} \int_{\gamma} -y dx + x dy &= \int_0^{2\pi} \left((-\sin(t))(-\sin(t)) + \cos(t)\cos(t) \right) dt = 2\pi, \\ \int_{\beta} -y dx + x dy &= \int_0^{2\pi} \left((-\sin(2t))(-2\sin(2t)) + \cos(t)(2\cos(t)) \right) dt = 4\pi. \end{aligned}$$

It is sometimes convenient to define a path integral over $\gamma: [a, b] \rightarrow \mathbb{R}^n$ that is not a path. Define

$$\int_{\gamma} \omega := \int_a^b \left(\sum_{j=1}^n \omega_j(\gamma(t)) \gamma_j'(t) \right) dt$$

for every continuously differentiable γ . A case that comes up naturally is when γ is constant. Then $\gamma'(t) = 0$ for all t , and $\gamma([a, b])$ is a single point, which we regard as a “curve” of length zero. Then, $\int_{\gamma} \omega = 0$ for every ω .

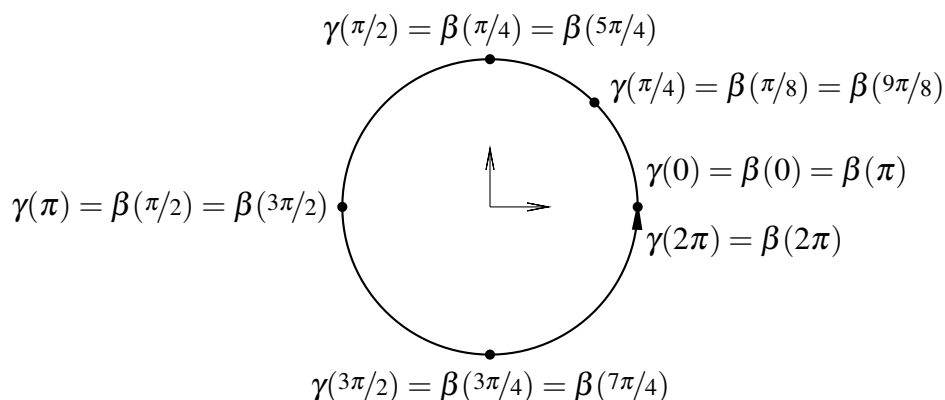

Figure 9.5: Circular path traversed once by $\gamma: [0, 2\pi] \rightarrow \mathbb{R}^2$ and twice by $\beta: [0, 2\pi] \rightarrow \mathbb{R}^2$.

9.2.3 Path integral of a function

Next we integrate a function against the so-called *arc-length measure* ds . The geometric picture we have in mind is the area under the graph of the function over a path. Imagine a fence erected over γ with height given by the function and the integral is the area of the fence. See [Figure 9.6](#).

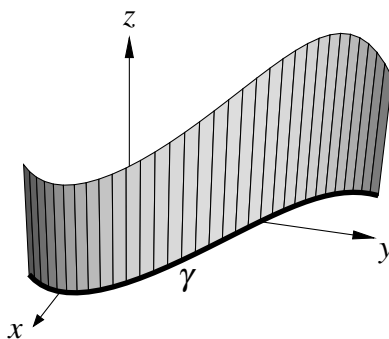

Figure 9.6: A path $\gamma: [a, b] \rightarrow \mathbb{R}^2$ in the xy -plane (bold curve), and a function $z = f(x, y)$ graphed above it in the z direction. The integral is the shaded area depicted.

Definition 9.2.14. Suppose $\gamma: [a, b] \rightarrow \mathbb{R}^n$ is a smooth path, and f is a continuous function defined on the image $\gamma([a, b])$. Then define

$$\int_{\gamma} f \, ds := \int_a^b f(\gamma(t)) \|\gamma'(t)\| \, dt.$$

To emphasize the variables we may use

$$\int_{\gamma} f(x) \, ds(x) := \int_{\gamma} f \, ds.$$

The definition for a piecewise smooth path is similar as before and is left to the reader.

The path integral of a function is also independent of the parametrization, and in this case, the orientation does not matter.

Proposition 9.2.15. *Let $\gamma: [a, b] \rightarrow \mathbb{R}^n$ be a piecewise smooth path and $\gamma \circ h: [c, d] \rightarrow \mathbb{R}^n$ a piecewise smooth reparametrization. Suppose f is a continuous function defined on the set $\gamma([a, b])$. Then*

$$\int_{\gamma \circ h} f \, ds = \int_{\gamma} f \, ds.$$

Proof. Suppose first that h is orientation preserving and that γ and h are both smooth. Then

$$\begin{aligned} \int_{\gamma} f \, ds &= \int_a^b f(\gamma(t)) \|\gamma'(t)\| \, dt \\ &= \int_c^d f(\gamma(h(\tau))) \|\gamma'(h(\tau))\| h'(\tau) \, d\tau \\ &= \int_c^d f(\gamma(h(\tau))) \|\gamma'(h(\tau)) h'(\tau)\| \, d\tau \\ &= \int_c^d f((\gamma \circ h)(\tau)) \|(\gamma \circ h)'(\tau)\| \, d\tau \\ &= \int_{\gamma \circ h} f \, ds. \end{aligned}$$

If h is orientation reversing it swaps the order of the limits on the integral, but you also have to introduce a minus sign in order to take h' inside the norm. The details, along with finishing the proof for piecewise smooth paths is left to the reader as [Exercise 9.2.5](#). \square

As before, due to this proposition (and the exercises), if γ is simple, it does not matter which parametrization we use. Therefore, if $\Gamma = \gamma([a, b])$, we can simply write

$$\int_{\Gamma} f \, ds.$$

In this case we also do not need to worry about orientation, either way we get the same integral.

Example 9.2.16: Let $f(x, y) := x$. Let $C \subset \mathbb{R}^2$ be half of the unit circle for $x \geq 0$. We wish to compute

$$\int_C f \, ds.$$

Parametrize the curve C via $\gamma: [-\pi/2, \pi/2] \rightarrow \mathbb{R}^2$ defined as $\gamma(t) := (\cos(t), \sin(t))$. Then $\gamma'(t) = (-\sin(t), \cos(t))$, and

$$\int_C f \, ds = \int_{\gamma} f \, ds = \int_{-\pi/2}^{\pi/2} \cos(t) \sqrt{(-\sin(t))^2 + (\cos(t))^2} \, dt = \int_{-\pi/2}^{\pi/2} \cos(t) \, dt = 2.$$

Definition 9.2.17. Suppose $\Gamma \subset \mathbb{R}^n$ is parametrized by a simple piecewise smooth path $\gamma: [a, b] \rightarrow \mathbb{R}^n$, that is $\gamma([a, b]) = \Gamma$. We define the *length* by

$$\ell(\Gamma) := \int_{\Gamma} ds = \int_{\gamma} ds.$$

If γ is smooth,

$$\ell(\Gamma) = \int_a^b \|\gamma'(t)\| dt.$$

This may be a good time to mention that it is common to write $\int_a^b \|\gamma'(t)\| dt$ even if the path is only piecewise smooth. That is because $\|\gamma'(t)\|$ is defined and continuous at all but finitely many points and is bounded, and so the integral exists.

Example 9.2.18: Let $x, y \in \mathbb{R}^n$ be two points and write $[x, y]$ as the straight line segment between the two points x and y . Parametrize $[x, y]$ by $\gamma(t) := (1-t)x + ty$ for t running between 0 and 1. See Figure 9.7. Then $\gamma'(t) = y - x$, and therefore

$$\ell([x, y]) = \int_{[x, y]} ds = \int_0^1 \|y - x\| dt = \|y - x\|.$$

So the length of $[x, y]$ is the standard euclidean distance between x and y , justifying the name.

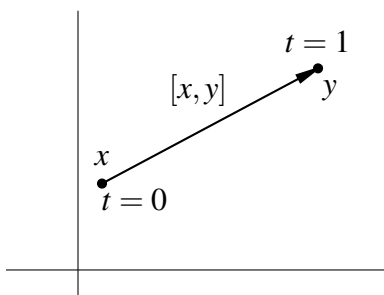

Figure 9.7: Straight path between x and y parametrized by $(1-t)x + ty$.

A simple piecewise smooth path $\gamma: [0, r] \rightarrow \mathbb{R}^n$ is said to be an *arc-length parametrization* if for all $t \in [0, r]$, we have

$$\ell(\gamma([0, t])) = t.$$

If γ is smooth, then

$$\int_0^t d\tau = t = \ell(\gamma([0, t])) = \int_0^t \|\gamma'(\tau)\| d\tau$$

for all t , which means that $\|\gamma'(t)\| = 1$ for all t . Similarly for piecewise smooth γ , we get $\|\gamma'(t)\| = 1$ for all t where the derivative exists. So you can think of such a parametrization as moving around your curve at speed 1. If $\gamma: [0, r] \rightarrow \mathbb{R}^n$ is an arclength parametrization, it is common to use s as the variable as $\int_\gamma f ds = \int_0^r f(\gamma(s)) ds$.

9.2.4 Exercises

Exercise 9.2.1: Show that if $\varphi: [a, b] \rightarrow \mathbb{R}^n$ is a piecewise smooth path as we defined it, then φ is a continuous function.

Exercise 9.2.2: Finish the proof of Proposition 9.2.6 for orientation reversing reparametrizations.

Exercise 9.2.3: Prove [Proposition 9.2.10](#).

Exercise 9.2.4: Finish the proof of [Proposition 9.2.12](#) for

- a) orientation reversing reparametrizations, and
- b) piecewise smooth paths and reparametrizations.

Exercise 9.2.5: Finish the proof of [Proposition 9.2.15](#) for

- a) orientation reversing reparametrizations, and
- b) piecewise smooth paths and reparametrizations.

Exercise 9.2.6: Suppose $\gamma: [a, b] \rightarrow \mathbb{R}^n$ is a piecewise smooth path, and f is a continuous function defined on the image $\gamma([a, b])$. Provide a definition of $\int_{\gamma} f \, ds$.

Exercise 9.2.7: Directly using the definitions compute:

- a) The arc-length of the unit square from [Example 9.2.2](#) using the given parametrization.
- b) The arc-length of the unit circle using the parametrization $\gamma: [0, 1] \rightarrow \mathbb{R}^2$, $\gamma(t) := (\cos(2\pi t), \sin(2\pi t))$.
- c) The arc-length of the unit circle using the parametrization $\beta: [0, 2\pi] \rightarrow \mathbb{R}^2$, $\beta(t) := (\cos(t), \sin(t))$.

Note: Feel free to use what you know about sine and cosine from calculus.

Exercise 9.2.8: Suppose $\gamma: [0, 1] \rightarrow \mathbb{R}^n$ is a smooth path, and ω is a one-form defined on the image $\gamma([a, b])$. For $r \in [0, 1]$, let $\gamma_r: [0, r] \rightarrow \mathbb{R}^n$ be defined as simply the restriction of γ to $[0, r]$. Show that the function $h(r) := \int_{\gamma_r} \omega$ is a continuously differentiable function on $[0, 1]$.

Exercise 9.2.9: Suppose $\gamma: [a, b] \rightarrow \mathbb{R}^n$ is a smooth path. Show that there exists an $\varepsilon > 0$ and a smooth function $\tilde{\gamma}: (a - \varepsilon, b + \varepsilon) \rightarrow \mathbb{R}^n$ with $\tilde{\gamma}(t) = \gamma(t)$ for all $t \in [a, b]$ and $\tilde{\gamma}'(t) \neq 0$ for all $t \in (a - \varepsilon, b + \varepsilon)$. That is, prove that a smooth path extends some small distance past the end points.

Exercise 9.2.10: Suppose $\alpha: [a, b] \rightarrow \mathbb{R}^n$ and $\beta: [c, d] \rightarrow \mathbb{R}^n$ are piecewise smooth paths such that $\Gamma := \alpha([a, b]) = \beta([c, d])$. Show that there exist finitely many points $\{p_1, p_2, \dots, p_k\} \in \Gamma$, such that the sets $\alpha^{-1}(\{p_1, p_2, \dots, p_k\})$ and $\beta^{-1}(\{p_1, p_2, \dots, p_k\})$ are partitions of $[a, b]$ and $[c, d]$ such that on every subinterval the paths are smooth (that is, they are partitions as in the definition of piecewise smooth path).

Exercise 9.2.11:

- a) Suppose $\gamma: [a, b] \rightarrow \mathbb{R}^n$ and $\alpha: [c, d] \rightarrow \mathbb{R}^n$ are two smooth paths that are one-to-one and $\gamma([a, b]) = \alpha([c, d])$. Then there exists a smooth reparametrization $h: [a, b] \rightarrow [c, d]$ such that $\gamma = \alpha \circ h$.

Hint 1: It is not hard to show h exists. The trick is to prove it is continuously differentiable with a nonzero derivative. Apply the implicit function theorem though it may at first seem the dimensions are wrong.

Hint 2: Worry about derivative of h in (a, b) first.

- b) Prove the same thing as part a, but now for simple closed paths with the further assumption that $\gamma(a) = \gamma(b) = \alpha(c) = \alpha(d)$.

- c) Prove parts a) and b) but for piecewise smooth paths, obtaining piecewise smooth reparametrizations.

Hint: The trick is to find two partitions such that when restricted to a subinterval of the partition both paths have the same image and are smooth, see the exercise above.

Exercise 9.2.12: Suppose $\alpha: [a, b] \rightarrow \mathbb{R}^n$ and $\beta: [b, c] \rightarrow \mathbb{R}^n$ are piecewise smooth paths with $\alpha(b) = \beta(b)$. Let $\gamma: [a, c] \rightarrow \mathbb{R}^n$ be defined by

$$\gamma(t) := \begin{cases} \alpha(t) & \text{if } t \in [a, b], \\ \beta(t) & \text{if } t \in (b, c]. \end{cases}$$

Show that γ is a piecewise smooth path, and that if ω is a one-form defined on the curve given by γ , then

$$\int_{\gamma} \omega = \int_{\alpha} \omega + \int_{\beta} \omega.$$

Exercise 9.2.13: Suppose $\gamma: [a, b] \rightarrow \mathbb{R}^n$ and $\beta: [c, d] \rightarrow \mathbb{R}^n$ are two simple closed piecewise smooth paths. That is, $\gamma(a) = \gamma(b)$ and $\beta(c) = \beta(d)$ and the restrictions $\gamma|_{[a, b]}$ and $\beta|_{[c, d]}$ are one-to-one. Suppose $\Gamma = \gamma([a, b]) = \beta([c, d])$ and ω is a one-form defined on $\Gamma \subset \mathbb{R}^n$. Show that either

$$\int_{\gamma} \omega = \int_{\beta} \omega, \quad \text{or} \quad \int_{\gamma} \omega = - \int_{\beta} \omega.$$

In particular, the notation $\int_{\Gamma} \omega$ makes sense if we indicate the direction in which the integral is evaluated. Hint: See previous three exercises.

Exercise 9.2.14: Suppose $\gamma: [a, b] \rightarrow \mathbb{R}^n$ and $\beta: [c, d] \rightarrow \mathbb{R}^n$ are two piecewise smooth paths which are one-to-one except at finitely many points. That is, there exist finite sets $S \subset [a, b]$ and $T \subset [c, d]$ such that $\gamma|_{[a, b] \setminus S}$ and $\beta|_{[c, d] \setminus T}$ are one-to-one. Suppose $\Gamma = \gamma([a, b]) = \beta([c, d])$ and ω is a one-form defined on $\Gamma \subset \mathbb{R}^n$. Show that either

$$\int_{\gamma} \omega = \int_{\beta} \omega, \quad \text{or} \quad \int_{\gamma} \omega = - \int_{\beta} \omega.$$

In particular, the notation $\int_{\Gamma} \omega$ makes sense if we indicate the direction in which the integral is evaluated. Hint: Same hint as the last exercise.

Exercise 9.2.15: Define $\gamma: [0, 1] \rightarrow \mathbb{R}^2$ by $\gamma(t) := \left(t^3 \sin(1/t), t(3t^2 \sin(1/t) - t \cos(1/t))^2 \right)$ for $t \neq 0$ and $\gamma(0) = (0, 0)$. Show that

- γ is continuously differentiable on $[0, 1]$.
- Show that there exists an infinite sequence $\{t_n\}$ in $[0, 1]$ converging to 0, such that $\gamma'(t_n) = (0, 0)$.
- Show that the points $\gamma(t_n)$ lie on the line $y = 0$ and such that the x -coordinate of $\gamma(t_n)$ alternates between positive and negative (if they do not alternate you only found a subsequence, you need to find them all).
- Show that there is no piecewise smooth α whose image equals $\gamma([0, 1])$. Hint: Look at part c) and show that α' must be zero where it reaches the origin.
- (Computer) If you know a plotting software that allows you to plot parametric curves, make a plot of the curve, but only for t in the range $[0, 0.1]$ otherwise you will not see the behavior. In particular, you should notice that $\gamma([0, 1])$ has infinitely many “corners” near the origin.

Note: Feel free to use what you know about sine and cosine from calculus.

9.3 Path independence

Note: 2 lectures

9.3.1 Path independent integrals

Let $U \subset \mathbb{R}^n$ be a set and ω a one-form defined on U . The integral of ω is said to be *path independent* if for every pair of points $x, y \in U$ and every pair of piecewise smooth paths $\gamma: [a, b] \rightarrow U$ and $\beta: [c, d] \rightarrow U$ such that $\gamma(a) = \beta(c) = x$ and $\gamma(b) = \beta(d) = y$, we have

$$\int_{\gamma} \omega = \int_{\beta} \omega.$$

In this case, we simply write

$$\int_x^y \omega := \int_{\gamma} \omega = \int_{\beta} \omega.$$

Not every one-form gives a path independent integral. Most do not.

Example 9.3.1: Let $\gamma: [0, 1] \rightarrow \mathbb{R}^2$ be the path $\gamma(t) := (t, 0)$ going from $(0, 0)$ to $(1, 0)$. Let $\beta: [0, 1] \rightarrow \mathbb{R}^2$ be the path $\beta(t) := (t, (1-t)t)$ also going between the same points. Then

$$\begin{aligned} \int_{\gamma} y \, dx &= \int_0^1 \gamma_2(t) \gamma_1'(t) \, dt = \int_0^1 0(1) \, dt = 0, \\ \int_{\beta} y \, dx &= \int_0^1 \beta_2(t) \beta_1'(t) \, dt = \int_0^1 (1-t)t(1) \, dt = \frac{1}{6}. \end{aligned}$$

The integral of $y \, dx$ is not path independent. In particular, $\int_{(0,0)}^{(1,0)} y \, dx$ does not make sense.

Definition 9.3.2. Let $U \subset \mathbb{R}^n$ be an open set and $f: U \rightarrow \mathbb{R}$ a continuously differentiable function. The one-form

$$df := \frac{\partial f}{\partial x_1} dx_1 + \frac{\partial f}{\partial x_2} dx_2 + \cdots + \frac{\partial f}{\partial x_n} dx_n$$

is called the *total derivative* of f .

An open set $U \subset \mathbb{R}^n$ is said to be *path connected*^{*} if for every two points x and y in U , there exists a piecewise smooth path starting at x and ending at y .

We leave as an exercise that every connected open set is path connected.

Proposition 9.3.3. Let $U \subset \mathbb{R}^n$ be a path connected open set and ω a one-form defined on U . Then $\int_x^y \omega$ is path independent (for all $x, y \in U$) if and only if there exists a continuously differentiable $f: U \rightarrow \mathbb{R}$ such that $\omega = df$.

In fact, if such an f exists, then for every pair of points $x, y \in U$

$$\int_x^y \omega = f(y) - f(x).$$

^{*}Normally only a continuous path is used in this definition, but for open sets the two definitions are equivalent. See the exercises.

In other words, if we fix $p \in U$, then $f(x) = C + \int_p^x \omega$ for some constant C .

Proof. First suppose that the integral is path independent. Pick $p \in U$. Since U is path connected, there exists a path from p to every $x \in U$. Define

$$f(x) := \int_p^x \omega.$$

Write $\omega = \omega_1 dx_1 + \omega_2 dx_2 + \cdots + \omega_n dx_n$. We wish to show that for every $j = 1, 2, \dots, n$, the partial derivative $\frac{\partial f}{\partial x_j}$ exists and is equal to ω_j .

Let e_j be an arbitrary standard basis vector, and h a nonzero real number. Compute

$$\frac{f(x + he_j) - f(x)}{h} = \frac{1}{h} \left(\int_p^{x+he_j} \omega - \int_p^x \omega \right) = \frac{1}{h} \int_x^{x+he_j} \omega,$$

which follows by [Proposition 9.2.10](#) and path independence as $\int_p^{x+he_j} \omega = \int_p^x \omega + \int_x^{x+he_j} \omega$, because we pick a path from p to $x + he_j$ that also happens to pass through x , and then we cut this path in two, see [Figure 9.8](#).

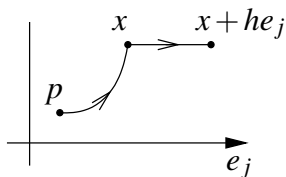

Figure 9.8: Using path independence in computing the partial derivative.

Since U is open, suppose h is so small so that all points of distance $|h|$ or less from x are in U . As the integral is path independent, pick the simplest path possible from x to $x + he_j$, that is $\gamma(t) := x + the_j$ for $t \in [0, 1]$. The path is in U . Notice $\gamma'(t) = he_j$ has only one nonzero component and that is the j th component, which is h . Therefore,

$$\frac{1}{h} \int_x^{x+he_j} \omega = \frac{1}{h} \int_\gamma \omega = \frac{1}{h} \int_0^1 \omega_j(x + the_j) h dt = \int_0^1 \omega_j(x + the_j) dt.$$

We wish to take the limit as $h \rightarrow 0$. The function ω_j is continuous at x . Given $\varepsilon > 0$, suppose h is small enough so that $|\omega_j(x) - \omega_j(y)| < \varepsilon$ whenever $\|x - y\| \leq |h|$. Thus, $|\omega_j(x + the_j) - \omega_j(x)| < \varepsilon$ for all $t \in [0, 1]$, and we estimate

$$\left| \int_0^1 \omega_j(x + the_j) dt - \omega_j(x) \right| = \left| \int_0^1 (\omega_j(x + the_j) - \omega_j(x)) dt \right| \leq \varepsilon.$$

That is,

$$\lim_{h \rightarrow 0} \frac{f(x + he_j) - f(x)}{h} = \omega_j(x).$$

All partials of f exist and are equal to ω_j , which are continuous functions. Thus, f is continuously differentiable, and furthermore $df = \omega$.

For the other direction, suppose a continuously differentiable f exists such that $df = \omega$. Take a smooth path $\gamma: [a, b] \rightarrow U$ such that $\gamma(a) = x$ and $\gamma(b) = y$. Then

$$\begin{aligned} \int_{\gamma} df &= \int_a^b \left(\frac{\partial f}{\partial x_1}(\gamma(t)) \gamma_1'(t) + \frac{\partial f}{\partial x_2}(\gamma(t)) \gamma_2'(t) + \cdots + \frac{\partial f}{\partial x_n}(\gamma(t)) \gamma_n'(t) \right) dt \\ &= \int_a^b \frac{d}{dt} [f(\gamma(t))] dt \\ &= f(y) - f(x). \end{aligned}$$

The value of the integral only depends on x and y , not the path taken. Therefore the integral is path independent. We leave checking this fact for a piecewise smooth path as an exercise. \square

Path independence can be stated more neatly in terms of integrals over closed paths.

Proposition 9.3.4. *Let $U \subset \mathbb{R}^n$ be a path connected open set and ω a one-form defined on U . Then $\omega = df$ for some continuously differentiable $f: U \rightarrow \mathbb{R}$ if and only if*

$$\int_{\gamma} \omega = 0 \quad \text{for every piecewise smooth closed path } \gamma: [a, b] \rightarrow U.$$

Proof. Suppose $\omega = df$ and let γ be a piecewise smooth closed path. Since $\gamma(a) = \gamma(b)$ for a closed path, the previous proposition says

$$\int_{\gamma} \omega = f(\gamma(b)) - f(\gamma(a)) = 0.$$

Now suppose that for every piecewise smooth closed path γ , $\int_{\gamma} \omega = 0$. Let x, y be two points in U and let $\alpha: [0, 1] \rightarrow U$ and $\beta: [0, 1] \rightarrow U$ be two piecewise smooth paths with $\alpha(0) = \beta(0) = x$ and $\alpha(1) = \beta(1) = y$. See [Figure 9.9](#).



Figure 9.9: Two paths from x to y .

Define $\gamma: [0, 2] \rightarrow U$ by

$$\gamma(t) := \begin{cases} \alpha(t) & \text{if } t \in [0, 1], \\ \beta(2-t) & \text{if } t \in (1, 2]. \end{cases}$$

This path is piecewise smooth. This is due to the fact that $\gamma|_{[0,1]}(t) = \alpha(t)$ and $\gamma|_{[1,2]}(t) = \beta(2-t)$ (note especially $\gamma(1) = \alpha(1) = \beta(2-1)$). It is also closed as $\gamma(0) = \alpha(0) = \beta(0) = \gamma(2)$. So

$$0 = \int_{\gamma} \omega = \int_{\alpha} \omega - \int_{\beta} \omega.$$

This follows first by [Proposition 9.2.10](#), and then noticing that the second part is β traveled backwards so that we get minus the β integral. Thus the integral of ω on U is path independent. \square

However one states path independence, it is often a difficult criterion to check, you have to check something “for all paths.” There is a local criterion, a differential equation, that guarantees path independence, or in other words it guarantees an *antiderivative* f whose total derivative is the given one-form ω . Since the criterion is local, we generally only find the function f locally. We can find the antiderivative in every so-called *simply connected* domain, which informally is a domain where every path between two points can be “continuously deformed” into any other path between those two points. But to make matters simple, we prove the result for so-called star-shaped domains, which is often good enough. As a bonus the proof in the star-shaped case constructs the antiderivative explicitly. As balls are star-shaped we then have the result locally.

Definition 9.3.5. Let $U \subset \mathbb{R}^n$ be an open set and $p \in U$. We say U is a *star-shaped domain* with respect to p if for every other point $x \in U$, the line segment $[p, x]$ is in U , that is, if $(1-t)p + tx \in U$ for all $t \in [0, 1]$. If we say simply *star-shaped*, then U is star-shaped with respect to some $p \in U$. See Figure 9.10.

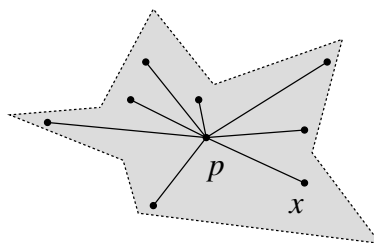

Figure 9.10: A star-shaped domain with respect to p .

Notice the difference between star-shaped and convex. A convex domain is star-shaped, but a star-shaped domain need not be convex.

Theorem 9.3.6 (Poincaré lemma). Let $U \subset \mathbb{R}^n$ be a star-shaped domain and ω a continuously differentiable one-form defined on U . That is, if

$$\omega = \omega_1 dx_1 + \omega_2 dx_2 + \cdots + \omega_n dx_n,$$

then $\omega_1, \omega_2, \dots, \omega_n$ are continuously differentiable functions. Suppose that for every j and k

$$\frac{\partial \omega_j}{\partial x_k} = \frac{\partial \omega_k}{\partial x_j},$$

then there exists a twice continuously differentiable function $f: U \rightarrow \mathbb{R}$ such that $df = \omega$.

The condition on the derivatives of ω is precisely the condition that the second partial derivatives commute. That is, if $df = \omega$, and f is twice continuously differentiable, then

$$\frac{\partial \omega_j}{\partial x_k} = \frac{\partial^2 f}{\partial x_k \partial x_j} = \frac{\partial^2 f}{\partial x_j \partial x_k} = \frac{\partial \omega_k}{\partial x_j}.$$

The condition is clearly necessary. The Poincaré lemma says that it is sufficient for a star-shaped U .

Proof. Suppose U is a star-shaped domain with respect to $p = (p_1, p_2, \dots, p_n) \in U$. Given $x = (x_1, x_2, \dots, x_n) \in U$, define the path $\gamma: [0, 1] \rightarrow U$ as $\gamma(t) := (1-t)p + tx$, so $\gamma'(t) = x - p$. Let

$$f(x) := \int_{\gamma} \omega = \int_0^1 \left(\sum_{k=1}^n \omega_k((1-t)p + tx) (x_k - p_k) \right) dt.$$

We differentiate in x_j under the integral, which is allowed as everything, including the partials, is continuous:

$$\begin{aligned} \frac{\partial f}{\partial x_j}(x) &= \int_0^1 \left(\left(\sum_{k=1}^n \frac{\partial \omega_k}{\partial x_j}((1-t)p + tx) t(x_k - p_k) \right) + \omega_j((1-t)p + tx) \right) dt \\ &= \int_0^1 \left(\left(\sum_{k=1}^n \frac{\partial \omega_j}{\partial x_k}((1-t)p + tx) t(x_k - p_k) \right) + \omega_j((1-t)p + tx) \right) dt \\ &= \int_0^1 \frac{d}{dt} [t\omega_j((1-t)p + tx)] dt \\ &= \omega_j(x). \end{aligned}$$

And this is precisely what we wanted. □

Example 9.3.7: Without some hypothesis on U the theorem is not true. Let

$$\omega(x, y) := \frac{-y}{x^2 + y^2} dx + \frac{x}{x^2 + y^2} dy$$

be defined on $\mathbb{R}^2 \setminus \{0\}$. Then

$$\frac{\partial}{\partial y} \left[\frac{-y}{x^2 + y^2} \right] = \frac{y^2 - x^2}{(x^2 + y^2)^2} = \frac{\partial}{\partial x} \left[\frac{x}{x^2 + y^2} \right].$$

However, there is no $f: \mathbb{R}^2 \setminus \{0\} \rightarrow \mathbb{R}$ such that $df = \omega$. In [Example 9.2.11](#) we integrated from $(1, 0)$ to $(1, 0)$ along the unit circle counterclockwise, that is $\gamma(t) = (\cos(t), \sin(t))$ for $t \in [0, 2\pi]$, and we found the integral to be 2π . We would have gotten 0 if the integral was path independent, or in other words if there would exist an f such that $df = \omega$.

9.3.2 Vector fields

A common object to integrate is a so-called vector field.

Definition 9.3.8. Let $U \subset \mathbb{R}^n$ be a set. A continuous function $v: U \rightarrow \mathbb{R}^n$ is called a *vector field*. Write $v = (v_1, v_2, \dots, v_n)$.

Given a smooth path $\gamma: [a, b] \rightarrow \mathbb{R}^n$ with $\gamma([a, b]) \subset U$ we define the path integral of the vectorfield v as

$$\int_{\gamma} v \cdot d\gamma := \int_a^b v(\gamma(t)) \cdot \gamma'(t) dt,$$

where the dot in the definition is the standard dot product. The definition for a piecewise smooth path is, again, done by integrating over each smooth interval and adding the results.

Unraveling the definition, we find that

$$\int_{\gamma} v \cdot d\gamma = \int_{\gamma} v_1 dx_1 + v_2 dx_2 + \cdots + v_n dx_n.$$

What we know about integration of one-forms carries over to the integration of vector fields. For example, path independence for integration of vector fields is simply that

$$\int_x^y v \cdot d\gamma$$

is path independent if and only if $v = \nabla f$, that is, v is the gradient of a function. The function f is then called a *potential* for v .

A vector field v whose path integrals are path independent is called a *conservative vector field*. The rationale for the naming is that such vector fields arise in physical systems where a certain quantity, the energy, is conserved.

9.3.3 Exercises

Exercise 9.3.1: Find an $f: \mathbb{R}^2 \rightarrow \mathbb{R}$ such that $df = xe^{x^2+y^2} dx + ye^{x^2+y^2} dy$.

Exercise 9.3.2: Find an $\omega_2: \mathbb{R}^2 \rightarrow \mathbb{R}$ such that there exists a continuously differentiable $f: \mathbb{R}^2 \rightarrow \mathbb{R}$ for which $df = e^{xy} dx + \omega_2 dy$.

Exercise 9.3.3: Finish the proof of [Proposition 9.3.3](#), that is, we only proved the second direction for a smooth path, not a piecewise smooth path.

Exercise 9.3.4: Show that a star-shaped domain $U \subset \mathbb{R}^n$ is path connected.

Exercise 9.3.5: Show that $U := \mathbb{R}^2 \setminus \{(x, y) \in \mathbb{R}^2 : x \leq 0, y = 0\}$ is star-shaped and find all points $(x_0, y_0) \in U$ such that U is star-shaped with respect to (x_0, y_0) .

Exercise 9.3.6: Suppose U_1 and U_2 are two open sets in \mathbb{R}^n with $U_1 \cap U_2$ nonempty and path connected. Suppose there exists an $f_1: U_1 \rightarrow \mathbb{R}$ and $f_2: U_2 \rightarrow \mathbb{R}$, both twice continuously differentiable such that $df_1 = df_2$ on $U_1 \cap U_2$. Then there exists a twice differentiable function $F: U_1 \cup U_2 \rightarrow \mathbb{R}$ such that $dF = df_1$ on U_1 and $dF = df_2$ on U_2 .

Exercise 9.3.7 (Hard): Let $\gamma: [a, b] \rightarrow \mathbb{R}^n$ be a simple nonclosed piecewise smooth path (so γ is one-to-one). Suppose ω is a continuously differentiable one-form defined on some open set V with $\gamma([a, b]) \subset V$ and $\frac{\partial \omega_j}{\partial x_k} = \frac{\partial \omega_k}{\partial x_j}$ for all j and k . Prove that there exists an open set U with $\gamma([a, b]) \subset U \subset V$ and a twice continuously differentiable function $f: U \rightarrow \mathbb{R}$ such that $df = \omega$.

Hint 1: $\gamma([a, b])$ is compact.

Hint 2: Show that you can cover the curve by finitely many balls in sequence so that the k th ball only intersects the $(k-1)$ th ball.

Hint 3: See previous exercise.

Exercise 9.3.8:

- a) Show that a connected open set $U \subset \mathbb{R}^n$ is path connected. Hint: Start with a point $x \in U$, and let $U_x \subset U$ is the set of points that are reachable by a path from x . Show that U_x and $U \setminus U_x$ are both open, and since U_x is nonempty ($x \in U_x$) it must be that $U_x = U$.
- b) Prove the converse, that is, an open* path connected set $U \subset \mathbb{R}^n$ is connected. Hint: For contradiction assume there exist two open and disjoint nonempty open sets and then assume there is a piecewise smooth (and therefore continuous) path between a point in one to a point in the other.

Exercise 9.3.9: Usually path connectedness is defined using continuous paths rather than piecewise smooth paths. Prove that for open subsets of \mathbb{R}^n the definitions are equivalent, in other words prove:

Suppose $U \subset \mathbb{R}^n$ is open and for every $x, y \in U$, there exists a continuous function $\gamma: [a, b] \rightarrow U$ such that $\gamma(a) = x$ and $\gamma(b) = y$. Then U is path connected, that is, there is a piecewise smooth path in U from x to y .

Exercise 9.3.10 (Hard): Take

$$\omega(x, y) = \frac{-y}{x^2 + y^2} dx + \frac{x}{x^2 + y^2} dy$$

defined on $\mathbb{R}^2 \setminus \{(0, 0)\}$. Let $\gamma: [a, b] \rightarrow \mathbb{R}^2 \setminus \{(0, 0)\}$ be a closed piecewise smooth path. Let $R := \{(x, y) \in \mathbb{R}^2 : x \leq 0 \text{ and } y = 0\}$. Suppose $R \cap \gamma([a, b])$ is a finite set of k points. Prove that

$$\int_{\gamma} \omega = 2\pi\ell$$

for some integer ℓ with $|\ell| \leq k$.

Hint 1: First prove that for a path β that starts and end on R but does not intersect it otherwise, you find that $\int_{\beta} \omega$ is -2π , 0 , or 2π .

Hint 2: You proved above that $\mathbb{R}^2 \setminus R$ is star-shaped.

Note: The number ℓ is called the winding number it measures how many times does γ wind around the origin in the clockwise direction.

*If the definition of “path connected” is as in the next exercise, “open” would not be needed for this part.

Chapter 10

Multivariable Integral

10.1 Riemann integral over rectangles

Note: 2–3 lectures

As in [chapter 5](#), we define the Riemann integral using the Darboux upper and lower integrals. The ideas in this section are very similar to integration in one dimension. The complication is mostly notational. The differences between one and several dimensions will grow more pronounced in the sections following.

10.1.1 Rectangles and partitions

Definition 10.1.1. Let (a_1, a_2, \dots, a_n) and (b_1, b_2, \dots, b_n) be such that $a_k \leq b_k$ for all k . A set of the form $[a_1, b_1] \times [a_2, b_2] \times \dots \times [a_n, b_n]$ is called a *closed rectangle*. In this setting it is sometimes useful to allow $a_k = b_k$, in which case we think of $[a_k, b_k] = \{a_k\}$ as usual. If $a_k < b_k$ for all k , then a set of the form $(a_1, b_1) \times (a_2, b_2) \times \dots \times (a_n, b_n)$ is called an *open rectangle*.

For an open or closed rectangle $R := [a_1, b_1] \times [a_2, b_2] \times \dots \times [a_n, b_n] \subset \mathbb{R}^n$ or $R := (a_1, b_1) \times (a_2, b_2) \times \dots \times (a_n, b_n) \subset \mathbb{R}^n$, we define the *n-dimensional volume* by

$$V(R) := (b_1 - a_1)(b_2 - a_2) \cdots (b_n - a_n).$$

A *partition* P of the closed rectangle $R = [a_1, b_1] \times [a_2, b_2] \times \dots \times [a_n, b_n]$ is a finite set of partitions P_1, P_2, \dots, P_n of the intervals $[a_1, b_1], [a_2, b_2], \dots, [a_n, b_n]$. We write $P = (P_1, P_2, \dots, P_n)$. That is, for every $k = 1, 2, \dots, n$ there is an integer ℓ_k and a finite set of numbers $P_k = \{x_{k,0}, x_{k,1}, x_{k,2}, \dots, x_{k,\ell_k}\}$ such that

$$a_k = x_{k,0} < x_{k,1} < x_{k,2} < \dots < x_{k,\ell_k-1} < x_{k,\ell_k} = b_k.$$

Picking a set of n integers j_1, j_2, \dots, j_n where $j_k \in \{1, 2, \dots, \ell_k\}$ we get the *subrectangle*

$$[x_{1,j_1-1}, x_{1,j_1}] \times [x_{2,j_2-1}, x_{2,j_2}] \times \dots \times [x_{n,j_n-1}, x_{n,j_n}].$$

We order the subrectangles somehow and we say $\{R_1, R_2, \dots, R_N\}$ are the subrectangles corresponding to the partition P of R , or more simply, subrectangles of P . In other words, we subdivided the

original rectangle into many smaller subrectangles. See Figure 10.1. It is not difficult to see that these subrectangles cover our original R , and their volumes sum to that of R . That is,

$$R = \bigcup_{k=1}^N R_k, \quad \text{and} \quad V(R) = \sum_{k=1}^N V(R_k).$$

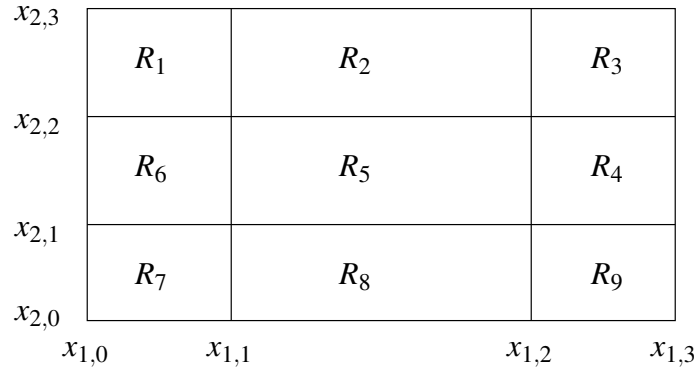

Figure 10.1: Example partition of a rectangle in \mathbb{R}^2 . The order of the subrectangles is not important.

When

$$R_i = [x_{1,j_1-1}, x_{1,j_1}] \times [x_{2,j_2-1}, x_{2,j_2}] \times \cdots \times [x_{n,j_n-1}, x_{n,j_n}],$$

then

$$V(R_i) = \Delta x_{1,j_1} \Delta x_{2,j_2} \cdots \Delta x_{n,j_n} = (x_{1,j_1} - x_{1,j_1-1})(x_{2,j_2} - x_{2,j_2-1}) \cdots (x_{n,j_n} - x_{n,j_n-1}).$$

Let $R \subset \mathbb{R}^n$ be a closed rectangle and let $f: R \rightarrow \mathbb{R}$ be a bounded function. Let P be a partition of R with N subrectangles R_1, R_2, \dots, R_N . Define

$$m_i := \inf\{f(x) : x \in R_i\},$$

$$M_i := \sup\{f(x) : x \in R_i\},$$

$$L(P, f) := \sum_{i=1}^N m_i V(R_i),$$

$$U(P, f) := \sum_{i=1}^N M_i V(R_i).$$

We call $L(P, f)$ the *lower Darboux sum* and $U(P, f)$ the *upper Darboux sum*.

The indexing in the definition may be complicated, but fortunately we do not need to go back directly to the definition often. We start by proving facts about the Darboux sums analogous to the one-variable results.

Proposition 10.1.2. *Suppose $R \subset \mathbb{R}^n$ is a closed rectangle and $f: R \rightarrow \mathbb{R}$ is a bounded function. Let $m, M \in \mathbb{R}$ be such that for all $x \in R$, we have $m \leq f(x) \leq M$. Then for every partition P of R ,*

$$mV(R) \leq L(P, f) \leq U(P, f) \leq MV(R).$$

Proof. Let P be a partition of R . For all i , we have $m \leq m_i \leq M_i \leq M$. Also $\sum_{i=1}^N V(R_i) = V(R)$. Therefore,

$$\begin{aligned}
 mV(R) &= m \left(\sum_{i=1}^N V(R_i) \right) = \sum_{i=1}^N mV(R_i) \leq \sum_{i=1}^N m_i V(R_i) \leq \\
 &\leq \sum_{i=1}^N M_i V(R_i) \leq \sum_{i=1}^N M V(R_i) = M \left(\sum_{i=1}^N V(R_i) \right) = MV(R). \quad \square
 \end{aligned}$$

10.1.2 Upper and lower integrals

By [Proposition 10.1.2](#), the set of upper and lower Darboux sums are bounded sets and we can take their infima and suprema. As in one variable, we make the following definition.

Definition 10.1.3. Let $f: R \rightarrow \mathbb{R}$ be a bounded function on a closed rectangle $R \subset \mathbb{R}^n$. Define

$$\int_R f := \sup \{ L(P, f) : P \text{ a partition of } R \}, \quad \overline{\int}_R f := \inf \{ U(P, f) : P \text{ a partition of } R \}.$$

We call \int the *lower Darboux integral* and $\overline{\int}$ the *upper Darboux integral*.

And as in one dimension, we define refinements of partitions.

Definition 10.1.4. Let $R \subset \mathbb{R}^n$ be a closed rectangle. Let $P = (P_1, P_2, \dots, P_n)$ and $\tilde{P} = (\tilde{P}_1, \tilde{P}_2, \dots, \tilde{P}_n)$ be partitions of R . We say \tilde{P} a *refinement* of P if, as sets, $P_k \subset P_k$ for all $k = 1, 2, \dots, n$.

If \tilde{P} is a refinement of P , then subrectangles of P are unions of subrectangles of \tilde{P} . Simply put, in a refinement, we take the subrectangles of P , and we cut them into smaller subrectangles and call that \tilde{P} . See [Figure 10.2](#).

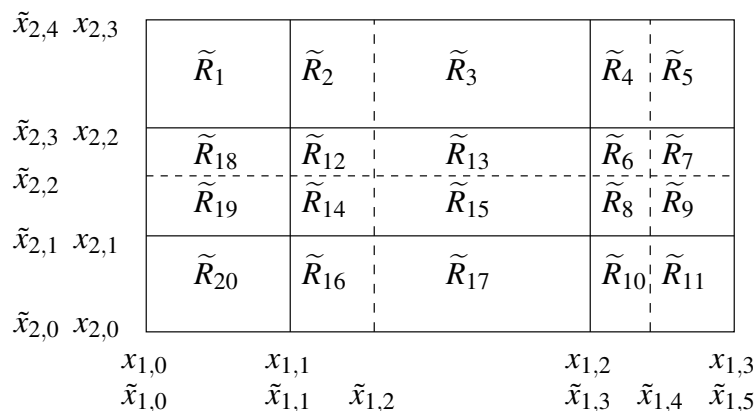

Figure 10.2: Example refinement of the partition from [Figure 10.1](#). New “cuts” are marked in dashed lines. The exact order of the new subrectangles does not matter.

Proposition 10.1.5. *Suppose $R \subset \mathbb{R}^n$ is a closed rectangle, P is a partition of R , and \tilde{P} is a refinement of P . If $f: R \rightarrow \mathbb{R}$ is bounded, then*

$$L(P, f) \leq L(\tilde{P}, f) \quad \text{and} \quad U(\tilde{P}, f) \leq U(P, f).$$

Proof. We prove the first inequality, and the second follows similarly. Let R_1, R_2, \dots, R_N be the subrectangles of P and $\tilde{R}_1, \tilde{R}_2, \dots, \tilde{R}_{\tilde{N}}$ be the subrectangles of \tilde{P} . Let I_k be the set of all indices j such that $\tilde{R}_j \subset R_k$. For example, in figures 10.1 and 10.2, $I_4 = \{6, 7, 8, 9\}$ as $R_4 = \tilde{R}_6 \cup \tilde{R}_7 \cup \tilde{R}_8 \cup \tilde{R}_9$. Then,

$$R_k = \bigcup_{j \in I_k} \tilde{R}_j, \quad V(R_k) = \sum_{j \in I_k} V(\tilde{R}_j).$$

Let $m_j := \inf\{f(x) : x \in R_j\}$, and $\tilde{m}_j := \inf\{f(x) : x \in \tilde{R}_j\}$ as usual. If $j \in I_k$, then $m_k \leq \tilde{m}_j$. Then

$$L(P, f) = \sum_{k=1}^N m_k V(R_k) = \sum_{k=1}^N \sum_{j \in I_k} m_k V(\tilde{R}_j) \leq \sum_{k=1}^N \sum_{j \in I_k} \tilde{m}_j V(\tilde{R}_j) = \sum_{j=1}^{\tilde{N}} \tilde{m}_j V(\tilde{R}_j) = L(\tilde{P}, f). \quad \square$$

The key point of this next proposition is that the lower Darboux integral is less than or equal to the upper Darboux integral.

Proposition 10.1.6. *Let $R \subset \mathbb{R}^n$ be a closed rectangle and $f: R \rightarrow \mathbb{R}$ a bounded function. Let $m, M \in \mathbb{R}$ be such that for all $x \in R$, we have $m \leq f(x) \leq M$. Then*

$$mV(R) \leq \int_{\underline{R}} f \leq \int_{\overline{R}} f \leq MV(R). \quad (10.1)$$

Proof. For every partition P , via Proposition 10.1.2,

$$mV(R) \leq L(P, f) \leq U(P, f) \leq MV(R).$$

Taking supremum of $L(P, f)$ and infimum of $U(P, f)$ over all partitions P , we obtain the first and the last inequality in (10.1).

The key inequality in (10.1) is the middle one. Let $P = (P_1, P_2, \dots, P_n)$ and $Q = (Q_1, Q_2, \dots, Q_n)$ be partitions of R . Define $\tilde{P} = (\tilde{P}_1, \tilde{P}_2, \dots, \tilde{P}_n)$ by letting $\tilde{P}_k := P_k \cup Q_k$. Then \tilde{P} is a partition of R as can easily be checked, and \tilde{P} is a refinement of P and a refinement of Q . By Proposition 10.1.5, $L(P, f) \leq L(\tilde{P}, f)$ and $U(\tilde{P}, f) \leq U(Q, f)$. Therefore,

$$L(P, f) \leq L(\tilde{P}, f) \leq U(\tilde{P}, f) \leq U(Q, f).$$

In other words, for two arbitrary partitions P and Q , we have $L(P, f) \leq U(Q, f)$. Via Proposition 1.2.7 from volume I, we obtain

$$\sup \{L(P, f) : P \text{ a partition of } R\} \leq \inf \{U(Q, f) : Q \text{ a partition of } R\}.$$

In other words, $\int_{\underline{R}} f \leq \int_{\overline{R}} f$. □

10.1.3 The Riemann integral

We have all we need to define the Riemann integral in n -dimensions over rectangles. Again, the Riemann integral is only defined on a certain class of functions, called the Riemann integrable functions.

Definition 10.1.7. Let $R \subset \mathbb{R}^n$ be a closed rectangle and $f: R \rightarrow \mathbb{R}$ a bounded function such that

$$\int_R f(x) dx = \overline{\int_R f(x) dx}.$$

Then f is said to be *Riemann integrable*, and we sometimes say simply *integrable*. The set of Riemann integrable functions on R is denoted by $\mathcal{R}(R)$. For $f \in \mathcal{R}(R)$ define the *Riemann integral*

$$\int_R f := \int_R f = \overline{\int_R f}.$$

When the variable $x \in \mathbb{R}^n$ needs to be emphasized, we write

$$\int_R f(x) dx, \quad \int_R f(x_1, \dots, x_n) dx_1 \cdots dx_n, \quad \text{or} \quad \int_R f(x) dV.$$

If $R \subset \mathbb{R}^2$, then we often say area instead of volume, and we write

$$\int_R f(x) dA.$$

[Proposition 10.1.6](#) immediately implies the following proposition.

Proposition 10.1.8. Let $f: R \rightarrow \mathbb{R}$ be a Riemann integrable function on a closed rectangle $R \subset \mathbb{R}^n$. Let $m, M \in \mathbb{R}$ be such that $m \leq f(x) \leq M$ for all $x \in R$. Then

$$mV(R) \leq \int_R f \leq MV(R).$$

Example 10.1.9: A constant function is Riemann integrable. Suppose $f(x) = c$ for all x on R . Then

$$cV(R) \leq \int_R f \leq \overline{\int_R f} \leq cV(R).$$

So f is integrable, and furthermore $\int_R f = cV(R)$.

The proofs of linearity and monotonicity are almost completely identical as the proofs from one variable. We therefore leave it as an exercise to prove the next two propositions.

Proposition 10.1.10 (Linearity). Let $R \subset \mathbb{R}^n$ be a closed rectangle and let f and g be in $\mathcal{R}(R)$ and $\alpha \in \mathbb{R}$.

(i) αf is in $\mathcal{R}(R)$ and

$$\int_R \alpha f = \alpha \int_R f.$$

(ii) $f + g$ is in $\mathcal{R}(R)$ and

$$\int_R (f + g) = \int_R f + \int_R g.$$

Proposition 10.1.11 (Monotonicity). *Let $R \subset \mathbb{R}^n$ be a closed rectangle, let f and g be in $\mathcal{R}(R)$, and suppose $f(x) \leq g(x)$ for all $x \in R$. Then*

$$\int_R f \leq \int_R g.$$

Checking for integrability using the definition often involves the following technique, as in the single variable case.

Proposition 10.1.12. *Let $R \subset \mathbb{R}^n$ be a closed rectangle and $f: R \rightarrow \mathbb{R}$ a bounded function. Then $f \in \mathcal{R}(R)$ if and only if for every $\varepsilon > 0$, there exists a partition P of R such that*

$$U(P, f) - L(P, f) < \varepsilon.$$

Proof. First, if f is integrable, then the supremum of $L(P, f)$ and infimum of $U(P, f)$ are equal and hence the infimum of $U(P, f) - L(P, f)$ is zero. Therefore, for every $\varepsilon > 0$ there must be some partition P such that $U(P, f) - L(P, f) < \varepsilon$.

For the other direction, given an $\varepsilon > 0$ find P such that $U(P, f) - L(P, f) < \varepsilon$.

$$\overline{\int}_R f - \underline{\int}_R f \leq U(P, f) - L(P, f) < \varepsilon.$$

As $\overline{\int}_R f \geq \underline{\int}_R f$ and the above holds for every $\varepsilon > 0$, we conclude $\overline{\int}_R f = \underline{\int}_R f$ and $f \in \mathcal{R}(R)$. \square

Suppose $f: S \rightarrow \mathbb{R}$ is a function and $R \subset S$ is a closed rectangle. If the restriction $f|_R$ is integrable, then for simplicity we say f is *integrable on R* , or $f \in \mathcal{R}(R)$ and we write

$$\int_R f := \int_R f|_R.$$

Proposition 10.1.13. *Let $S \subset \mathbb{R}^n$ be a closed rectangle. If $f: S \rightarrow \mathbb{R}$ is integrable and $R \subset S$ is a closed rectangle, then f is integrable on R .*

Proof. Given $\varepsilon > 0$, we find a partition P of S such that $U(P, f) - L(P, f) < \varepsilon$. By making a refinement of P if necessary, we assume that the endpoints of R are in P . In other words, R is a union of subrectangles of P . The subrectangles of P divide into two collections, ones that are subsets of R and ones whose intersection with the interior of R is empty. Suppose R_1, R_2, \dots, R_K are the subrectangles that are subsets of R and let R_{K+1}, \dots, R_N be the rest. Let \tilde{P} be the partition of R composed of those subrectangles of P contained in R . Using the same notation as before,

$$\begin{aligned} \varepsilon > U(P, f) - L(P, f) &= \sum_{k=1}^K (M_k - m_k)V(R_k) + \sum_{k=K+1}^N (M_k - m_k)V(R_k) \\ &\geq \sum_{k=1}^K (M_k - m_k)V(R_k) = U(\tilde{P}, f|_R) - L(\tilde{P}, f|_R). \end{aligned}$$

Therefore, $f|_R$ is integrable. \square

10.1.4 Integrals of continuous functions

Although we will prove a more general result later, it is useful to start with integrability of continuous functions. First we wish to measure the fineness of partitions. In one variable, we measured the length of a subinterval, in several variables, we similarly measure the sides of a subrectangle. We say a rectangle $R = [a_1, b_1] \times [a_2, b_2] \times \cdots \times [a_n, b_n]$ has *longest side at most α* if $b_k - a_k \leq \alpha$ for all $k = 1, 2, \dots, n$.

Proposition 10.1.14. *If a rectangle $R \subset \mathbb{R}^n$ has longest side at most α , then for all $x, y \in R$,*

$$\|x - y\| \leq \sqrt{n} \alpha.$$

Proof.

$$\begin{aligned} \|x - y\| &= \sqrt{(x_1 - y_1)^2 + (x_2 - y_2)^2 + \cdots + (x_n - y_n)^2} \\ &\leq \sqrt{(b_1 - a_1)^2 + (b_2 - a_2)^2 + \cdots + (b_n - a_n)^2} \\ &\leq \sqrt{\alpha^2 + \alpha^2 + \cdots + \alpha^2} = \sqrt{n} \alpha. \end{aligned} \quad \square$$

Theorem 10.1.15. *Let $R \subset \mathbb{R}^n$ be a closed rectangle. If $f: R \rightarrow \mathbb{R}$ is continuous, then $f \in \mathcal{R}(R)$.*

Proof. The proof is analogous to the one-variable proof with some complications. The set R is a closed and bounded subset of \mathbb{R}^n , and hence compact. So f is not just continuous, but in fact uniformly continuous by Theorem 7.5.11 from volume I. Let $\varepsilon > 0$ be given. Find a $\delta > 0$ such that $\|x - y\| < \delta$ implies $|f(x) - f(y)| < \frac{\varepsilon}{V(R)}$.

Let P be a partition of R , such that longest side of every subrectangle is strictly less than $\frac{\delta}{\sqrt{n}}$. If $x, y \in R_k$ for some subrectangle R_k of P , then, by the proposition above, $\|x - y\| < \sqrt{n} \frac{\delta}{\sqrt{n}} = \delta$. Therefore,

$$f(x) - f(y) \leq |f(x) - f(y)| < \frac{\varepsilon}{V(R)}.$$

As f is continuous on R_k , it attains a maximum and a minimum on this subrectangle. Let x be a point where f attains the maximum and y be a point where f attains the minimum. Then $f(x) = M_k$ and $f(y) = m_k$ in the notation from the definition of the integral. Therefore,

$$M_k - m_k = f(x) - f(y) < \frac{\varepsilon}{V(R)}.$$

And so

$$\begin{aligned} U(P, f) - L(P, f) &= \left(\sum_{k=1}^N M_k V(R_k) \right) - \left(\sum_{k=1}^N m_k V(R_k) \right) \\ &= \sum_{k=1}^N (M_k - m_k) V(R_k) \\ &< \frac{\varepsilon}{V(R)} \sum_{k=1}^N V(R_k) = \varepsilon. \end{aligned}$$

Via application of [Proposition 10.1.12](#), we find that $f \in \mathcal{R}(R)$. □

10.1.5 Integration of functions with compact support

Let $U \subset \mathbb{R}^n$ be an open set and $f: U \rightarrow \mathbb{R}$ be a function. The *support* of f is the set

$$\text{supp}(f) := \overline{\{x \in U : f(x) \neq 0\}},$$

where the closure is with respect to the subspace topology on U . Taking the closure with respect to the subspace topology is the same as $\overline{\{x \in U : f(x) \neq 0\}} \cap U$, where the closure is with respect to the ambient euclidean space \mathbb{R}^n . In particular, $\text{supp}(f) \subset U$. The support is the closure (in U) of the set of points where the function is nonzero. Its complement in U is open. If $x \in U$ and x is not in the support of f , then f is constantly zero in a whole neighborhood of x .

A function f is said to have *compact support* if $\text{supp}(f)$ is a compact set.

Example 10.1.16: The function $f: \mathbb{R}^2 \rightarrow \mathbb{R}$ defined by

$$f(x, y) := \begin{cases} -x(x^2 + y^2 - 1)^2 & \text{if } \sqrt{x^2 + y^2} \leq 1, \\ 0 & \text{else,} \end{cases}$$

is continuous and its support is the closed unit disc $C(0, 1) = \{(x, y) : \sqrt{x^2 + y^2} \leq 1\}$, which is a compact set, so f has compact support. Do note that the function is zero on the entire y -axis and on the unit circle, but all points that lie in the closed unit disc are still within the support as they are in the closure of points where f is nonzero. See [Figure 10.3](#).

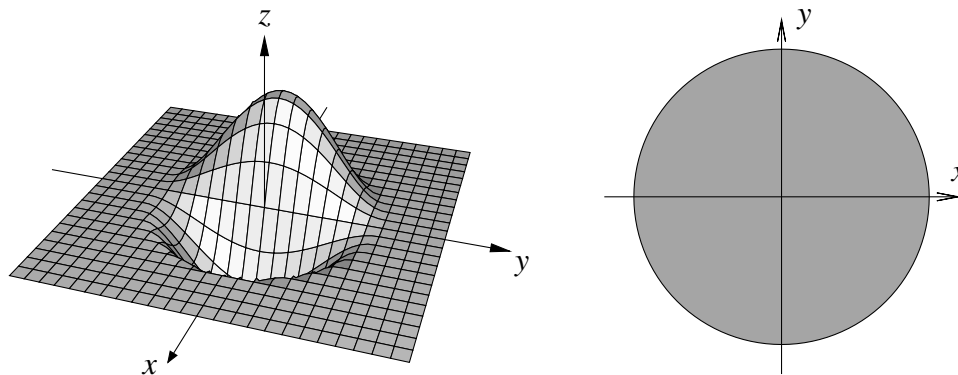

Figure 10.3: Function with compact support (left), the support is the closed unit disc (right).

If $U \neq \mathbb{R}^n$, then you must be careful to take the closure in U . Consider the following two examples.

Example 10.1.17: Let $B(0, 1) \subset \mathbb{R}^2$ be the unit disc. The function $f: B(0, 1) \rightarrow \mathbb{R}$ defined by

$$f(x, y) := \begin{cases} 0 & \text{if } \sqrt{x^2 + y^2} > 1/2, \\ 1/2 - \sqrt{x^2 + y^2} & \text{if } \sqrt{x^2 + y^2} \leq 1/2, \end{cases}$$

is continuous on $B(0, 1)$ and its support is the smaller closed ball $C(0, 1/2)$. As that is a compact set, f has compact support.

The function $g: B(0, 1) \rightarrow \mathbb{R}$ defined by

$$g(x, y) := \begin{cases} 0 & \text{if } x \leq 0, \\ x & \text{if } x > 0, \end{cases}$$

is continuous on $B(0, 1)$, but its support is the set $\{(x, y) \in B(0, 1) : x \geq 0\}$. In particular, g is not compactly supported.

We really only need to consider the case when $U = \mathbb{R}^n$. In light of [Exercise 10.1.1](#), which says every continuous function on an open $U \subset \mathbb{R}^n$ with compact support can be extended to a continuous function with compact support on \mathbb{R}^n , considering $U = \mathbb{R}^n$ is not an oversimplification.

Example 10.1.18: The continuous function $f: B(0, 1) \rightarrow \mathbb{R}$ defined by $f(x, y) := \sin\left(\frac{1}{1-x^2-y^2}\right)$, does not have compact support; as f is not constantly zero on neighborhood of every point in $B(0, 1)$, the support is the entire disc $B(0, 1)$. The function does not extend as above to a continuous function on \mathbb{R}^2 . In fact, it is not difficult to show that f cannot be extended in any way whatsoever to be continuous on all of \mathbb{R}^2 (the boundary of the disc is the problem).

Proposition 10.1.19. *Suppose $f: \mathbb{R}^n \rightarrow \mathbb{R}$ is a continuous function with compact support. If R and S are closed rectangles such that $\text{supp}(f) \subset R$ and $\text{supp}(f) \subset S$, then*

$$\int_S f = \int_R f.$$

Proof. As f is continuous, it is automatically integrable on the rectangles R , S , and $R \cap S$. Then [Exercise 10.1.7](#) says $\int_S f = \int_{S \cap R} f = \int_R f$. \square

Because of this proposition, when $f: \mathbb{R}^n \rightarrow \mathbb{R}$ has compact support and is integrable on a rectangle R containing the support we write

$$\int f := \int_R f \quad \text{or} \quad \int_{\mathbb{R}^n} f := \int_R f.$$

For example, if f is continuous and of compact support, then $\int_{\mathbb{R}^n} f$ exists.

10.1.6 Exercises

Exercise 10.1.1: *Suppose $U \subset \mathbb{R}^n$ is open and $f: U \rightarrow \mathbb{R}$ is continuous and of compact support. Show that the function $\tilde{f}: \mathbb{R}^n \rightarrow \mathbb{R}$*

$$\tilde{f}(x) := \begin{cases} f(x) & \text{if } x \in U, \\ 0 & \text{otherwise,} \end{cases}$$

is continuous.

Exercise 10.1.2: *Prove [Proposition 10.1.10](#).*

Exercise 10.1.3: *Suppose R is a rectangle with the length of one of the sides equal to 0. For every bounded function f , show that $f \in \mathcal{R}(R)$ and $\int_R f = 0$.*

Exercise 10.1.4: Suppose R is a rectangle with the length of one of the sides equal to 0, and suppose S is a rectangle with $R \subset S$. If f is a bounded function such that $f(x) = 0$ for $x \in R \setminus S$, show that $f \in \mathcal{R}(R)$ and $\int_R f = 0$.

Exercise 10.1.5: Suppose $f: \mathbb{R}^n \rightarrow \mathbb{R}$ is such that $f(x) := 0$ if $x \neq 0$ and $f(0) := 1$. Show that f is integrable on $R := [-1, 1] \times [-1, 1] \times \cdots \times [-1, 1]$ directly using the definition, and find $\int_R f$.

Exercise 10.1.6: Suppose R is a closed rectangle and $h: R \rightarrow \mathbb{R}$ is a bounded function such that $h(x) = 0$ if $x \notin \partial R$ (the boundary of R). Let S be a closed rectangle. Show that $h \in \mathcal{R}(S)$ and

$$\int_S h = 0.$$

Hint: Write h as a sum of functions as in [Exercise 10.1.4](#).

Exercise 10.1.7: Suppose R and R' are two closed rectangles with $R' \subset R$. Suppose $f: R \rightarrow \mathbb{R}$ is in $\mathcal{R}(R')$ and $f(x) = 0$ for $x \in R \setminus R'$. Show that $f \in \mathcal{R}(R)$ and

$$\int_{R'} f = \int_R f.$$

Do this in the following steps.

- First do the proof assuming that furthermore $f(x) = 0$ whenever $x \in \overline{R \setminus R'}$.
- Write $f(x) = g(x) + h(x)$ where $g(x) = 0$ whenever $x \in \overline{R \setminus R'}$, and $h(x)$ is zero except perhaps on $\partial R'$. Then show $\int_R h = \int_{R'} h = 0$ (see [Exercise 10.1.6](#)).
- Show $\int_{R'} f = \int_R f$.

Exercise 10.1.8: Suppose $R' \subset \mathbb{R}^n$ and $R'' \subset \mathbb{R}^n$ are two rectangles such that $R = R' \cup R''$ is a rectangle, and $R' \cap R''$ is rectangle with one of the sides having length 0 (that is $V(R' \cap R'') = 0$). Let $f: R \rightarrow \mathbb{R}$ be a function such that $f \in \mathcal{R}(R')$ and $f \in \mathcal{R}(R'')$. Show that $f \in \mathcal{R}(R)$ and

$$\int_R f = \int_{R'} f + \int_{R''} f.$$

Hint: See previous exercise.

Exercise 10.1.9: Prove a stronger version of [Proposition 10.1.19](#). Suppose $f: \mathbb{R}^n \rightarrow \mathbb{R}$ is a function with compact support but not necessarily continuous. Prove that if R is a closed rectangle such that $\text{supp}(f) \subset R$ and f is integrable on R , then for every other closed rectangle S with $\text{supp}(f) \subset S$, the function f is integrable on S and $\int_S f = \int_R f$. Hint: See [Exercise 10.1.7](#).

Exercise 10.1.10: Suppose R and S are closed rectangles of \mathbb{R}^n . Define $f: \mathbb{R}^n \rightarrow \mathbb{R}$ as $f(x) := 1$ if $x \in R$, and $f(x) := 0$ otherwise. Prove f is integrable on S and compute $\int_S f$. Hint: Consider $S \cap R$.

Exercise 10.1.11: Let $R := [0, 1] \times [0, 1] \subset \mathbb{R}^2$.

- Suppose $f: R \rightarrow \mathbb{R}$ is defined by

$$f(x, y) := \begin{cases} 1 & \text{if } x = y, \\ 0 & \text{else.} \end{cases}$$

Show that $f \in \mathcal{R}(R)$ and compute $\int_R f$.

- Suppose $f: R \rightarrow \mathbb{R}$ is defined by

$$f(x, y) := \begin{cases} 1 & \text{if } x \in \mathbb{Q} \text{ or } y \in \mathbb{Q}, \\ 0 & \text{else.} \end{cases}$$

Show that $f \notin \mathcal{R}(R)$.

Exercise 10.1.12: Suppose R is a closed rectangle, and suppose S_j are closed rectangles such that $S_j \subset R$ and $S_j \subset S_{j+1}$ for all j . Suppose $f: R \rightarrow \mathbb{R}$ is bounded and $f \in \mathcal{R}(S_j)$ for all j . Show that $f \in \mathcal{R}(R)$ and

$$\lim_{j \rightarrow \infty} \int_{S_j} f = \int_R f.$$

Exercise 10.1.13: Suppose $f: [-1, 1] \times [-1, 1] \rightarrow \mathbb{R}$ is a Riemann integrable function such $f(x) = -f(-x)$. Using the definition prove

$$\int_{[-1,1] \times [-1,1]} f = 0.$$

10.2 Iterated integrals and Fubini theorem

Note: 1–2 lectures

The Riemann integral in several variables is hard to compute by the definition. For one-dimensional Riemann integral, we have the fundamental theorem of calculus, and we can compute many integrals without having to appeal to the definition of the integral. We will rewrite a Riemann integral in several variables into several one-dimensional Riemann integrals by iterating. However, if $f: [0, 1]^2 \rightarrow \mathbb{R}$ is a Riemann integrable function, it is not immediately clear if the three expressions

$$\int_{[0,1]^2} f, \quad \int_0^1 \int_0^1 f(x,y) dx dy, \quad \text{and} \quad \int_0^1 \int_0^1 f(x,y) dy dx$$

are equal, or if the last two are even well-defined.

Example 10.2.1: Define

$$f(x,y) := \begin{cases} 1 & \text{if } x = 1/2 \text{ and } y \in \mathbb{Q}, \\ 0 & \text{otherwise.} \end{cases}$$

Then f is Riemann integrable on $R := [0, 1]^2$ and $\int_R f = 0$. Furthermore, $\int_0^1 \int_0^1 f(x,y) dx dy = 0$. However,

$$\int_0^1 f(1/2,y) dy$$

does not exist, so we cannot even write $\int_0^1 \int_0^1 f(x,y) dy dx$.

Proof: Let us start with integrability of f . Consider the partition of $[0, 1]^2$ where the partition in the x direction is $\{0, 1/2 - \varepsilon, 1/2 + \varepsilon, 1\}$ and in the y direction $\{0, 1\}$. The subrectangles of the partition are

$$R_1 := [0, 1/2 - \varepsilon] \times [0, 1], \quad R_2 := [1/2 - \varepsilon, 1/2 + \varepsilon] \times [0, 1], \quad R_3 := [1/2 + \varepsilon, 1] \times [0, 1].$$

We have $m_1 = M_1 = 0$, $m_2 = 0$, $M_2 = 1$, and $m_3 = M_3 = 0$. Therefore,

$$L(P, f) = m_1 V(R_1) + m_2 V(R_2) + m_3 V(R_3) = 0(1/2 - \varepsilon) + 0(2\varepsilon) + 0(1/2 - \varepsilon) = 0,$$

and

$$U(P, f) = M_1 V(R_1) + M_2 V(R_2) + M_3 V(R_3) = 0(1/2 - \varepsilon) + 1(2\varepsilon) + 0(1/2 - \varepsilon) = 2\varepsilon.$$

The upper and lower sums are arbitrarily close and the lower sum is always zero, so the function is integrable and $\int_R f = 0$.

For every fixed y , the function that takes x to $f(x,y)$ is zero except perhaps at a single point $x = 1/2$. Such a function is integrable and $\int_0^1 f(x,y) dx = 0$. Therefore, $\int_0^1 \int_0^1 f(x,y) dx dy = 0$.

However, if $x = 1/2$, the function that takes y to $f(1/2,y)$ is the nonintegrable function that is 1 on the rationals and 0 on the irrationals. See Example 5.1.4 from volume I.

We solve this problem of undefined inside integrals by using the upper and lower integrals, which are always defined.

Split the coordinates of \mathbb{R}^{n+m} into two parts: write the coordinates on $\mathbb{R}^{n+m} = \mathbb{R}^n \times \mathbb{R}^m$ as (x, y) where $x \in \mathbb{R}^n$ and $y \in \mathbb{R}^m$. For a function $f(x, y)$, write

$$f_x(y) := f(x, y)$$

when x is fixed and we wish to speak of the function in terms of y . Write

$$f^y(x) := f(x, y)$$

when y is fixed and we wish to speak of the function in terms of x .

Theorem 10.2.2 (Fubini version A*). *Let $R \times S \subset \mathbb{R}^n \times \mathbb{R}^m$ be a closed rectangle and $f: R \times S \rightarrow \mathbb{R}$ be integrable. The functions $g: R \rightarrow \mathbb{R}$ and $h: R \rightarrow \mathbb{R}$ defined by*

$$g(x) := \int_S f_x \quad \text{and} \quad h(x) := \int_S f_x$$

are integrable on R and

$$\int_R g = \int_R h = \int_{R \times S} f.$$

In other words,

$$\int_{R \times S} f = \int_R \left(\int_S f(x, y) dy \right) dx = \int_R \left(\int_S f(x, y) dy \right) dx.$$

If it turns out that f_x is integrable for all x , for example when f is continuous, then we obtain the more familiar

$$\int_{R \times S} f = \int_R \int_S f(x, y) dy dx.$$

Proof. Any partition of $R \times S$ is a concatenation of a partition of R and a partition of S . That is, write a partition of $R \times S$ as $(P, P') = (P_1, P_2, \dots, P_n, P'_1, P'_2, \dots, P'_m)$, where $P = (P_1, P_2, \dots, P_n)$ and $P' = (P'_1, P'_2, \dots, P'_m)$ are partitions of R and S respectively. Let R_1, R_2, \dots, R_N be the subrectangles of P and R'_1, R'_2, \dots, R'_K be the subrectangles of P' . Then the subrectangles of (P, P') are $R_j \times R'_k$ where $1 \leq j \leq N$ and $1 \leq k \leq K$.

Let

$$m_{j,k} := \inf_{(x,y) \in R_j \times R'_k} f(x, y).$$

We notice that $V(R_j \times R'_k) = V(R_j)V(R'_k)$ and hence

$$L((P, P'), f) = \sum_{j=1}^N \sum_{k=1}^K m_{j,k} V(R_j \times R'_k) = \sum_{j=1}^N \left(\sum_{k=1}^K m_{j,k} V(R'_k) \right) V(R_j).$$

If we let

$$m_k(x) := \inf_{y \in R'_k} f(x, y) = \inf_{y \in R'_k} f_x(y),$$

*Named after the Italian mathematician [Guido Fubini](#) (1879–1943).

then of course if $x \in R_j$, then $m_{j,k} \leq m_k(x)$. Therefore,

$$\sum_{k=1}^K m_{j,k} V(R'_k) \leq \sum_{k=1}^K m_k(x) V(R'_k) = L(P', f_x) \leq \int_S f_x = g(x).$$

As we have the inequality for all $x \in R_j$, we have

$$\sum_{k=1}^K m_{j,k} V(R'_k) \leq \inf_{x \in R_j} g(x).$$

We thus obtain

$$L((P, P'), f) \leq \sum_{j=1}^N \left(\inf_{x \in R_j} g(x) \right) V(R_j) = L(P, g).$$

Similarly $U((P, P'), f) \geq U(P, h)$, and the proof of this inequality is left as an exercise.

Putting this together, we have

$$L((P, P'), f) \leq L(P, g) \leq U(P, g) \leq U(P, h) \leq U((P, P'), f).$$

And since f is integrable, it must be that g is integrable as

$$U(P, g) - L(P, g) \leq U((P, P'), f) - L((P, P'), f),$$

and we can make the right-hand side arbitrarily small. As for any partition we have $L((P, P'), f) \leq L(P, g) \leq U((P, P'), f)$, we must have $\int_R g = \int_{R \times S} f$.

Similarly,

$$L((P, P'), f) \leq L(P, g) \leq L(P, h) \leq U(P, h) \leq U((P, P'), f),$$

and hence

$$U(P, h) - L(P, h) \leq U((P, P'), f) - L((P, P'), f).$$

If f is integrable, so is h . As $L((P, P'), f) \leq L(P, h) \leq U((P, P'), f)$ we must have that $\int_R h = \int_{R \times S} f$. \square

We can also do the iterated integration in the opposite order. The proof of this version is almost identical to version A (or follows quickly from version A), and we leave it as an exercise to the reader.

Theorem 10.2.3 (Fubini version B). *Let $R \times S \subset \mathbb{R}^n \times \mathbb{R}^m$ be a closed rectangle and $f: R \times S \rightarrow \mathbb{R}$ be integrable. The functions $g: S \rightarrow \mathbb{R}$ and $h: S \rightarrow \mathbb{R}$ defined by*

$$g(y) := \int_R f^y \quad \text{and} \quad h(y) := \overline{\int_R f^y}$$

are integrable on S and

$$\int_S g = \int_S h = \int_{R \times S} f.$$

That is,

$$\int_{R \times S} f = \int_S \left(\int_R f(x, y) dx \right) dy = \int_S \left(\int_R f(x, y) dx \right) dy.$$

Next suppose f_x and f_y are integrable. For example, suppose f is continuous. By putting the two versions together we obtain the familiar

$$\int_{R \times S} f = \int_R \int_S f(x, y) dy dx = \int_S \int_R f(x, y) dx dy.$$

Often the Fubini theorem is stated in two dimensions for a continuous function $f: R \rightarrow \mathbb{R}$ on a rectangle $R = [a, b] \times [c, d]$. Then the Fubini theorem states that

$$\int_R f = \int_a^b \int_c^d f(x, y) dy dx = \int_c^d \int_a^b f(x, y) dx dy.$$

The Fubini theorem is commonly thought of as *the* theorem that allows us to swap the order of iterated integrals, although there are many variations on Fubini, and we have seen but two of them.

Repeatedly applying Fubini theorem gets us the following corollary: Let $R := [a_1, b_1] \times [a_2, b_2] \times \cdots \times [a_n, b_n] \subset \mathbb{R}^n$ be a closed rectangle and let $f: R \rightarrow \mathbb{R}$ be continuous. Then

$$\int_R f = \int_{a_1}^{b_1} \int_{a_2}^{b_2} \cdots \int_{a_n}^{b_n} f(x_1, x_2, \dots, x_n) dx_n dx_{n-1} \cdots dx_1.$$

Clearly we may switch the order of integration to any order we please. We may also relax the continuity requirement by making sure that all the intermediate functions are integrable, or by using upper or lower integrals appropriately.

10.2.1 Exercises

Exercise 10.2.1: Compute $\int_0^1 \int_{-1}^1 x e^{xy} dx dy$ in a simple way.

Exercise 10.2.2: Prove the assertion $U((P, P'), f) \geq U(P, h)$ from the proof of [Theorem 10.2.2](#).

Exercise 10.2.3 (Easy): Prove [Theorem 10.2.3](#).

Exercise 10.2.4: Let $R := [a, b] \times [c, d]$ and $f(x, y)$ is an integrable function on R such that for every fixed y , the function that takes x to $f(x, y)$ is zero except at finitely many points. Show

$$\int_R f = 0.$$

Exercise 10.2.5: Let $R := [a, b] \times [c, d]$ and $f(x, y) := g(x)h(y)$ for two continuous functions $g: [a, b] \rightarrow \mathbb{R}$ and $h: [c, d] \rightarrow \mathbb{R}$. Prove

$$\int_R f = \left(\int_a^b g \right) \left(\int_c^d h \right).$$

Exercise 10.2.6: Compute

$$\int_0^1 \int_0^1 \frac{x^2 - y^2}{(x^2 + y^2)^2} dx dy \quad \text{and} \quad \int_0^1 \int_0^1 \frac{x^2 - y^2}{(x^2 + y^2)^2} dy dx.$$

You will need to interpret the integrals as improper, that is, the limit of \int_ε^1 as $\varepsilon \rightarrow 0^+$.

Exercise 10.2.7: Suppose $f(x, y) := g(x)$ where $g: [a, b] \rightarrow \mathbb{R}$ is Riemann integrable. Show that f is Riemann integrable for every $R = [a, b] \times [c, d]$ and

$$\int_R f = (d - c) \int_a^b g.$$

Exercise 10.2.8: Define $f: [-1, 1] \times [0, 1] \rightarrow \mathbb{R}$ by

$$f(x, y) := \begin{cases} x & \text{if } y \in \mathbb{Q}, \\ 0 & \text{else.} \end{cases}$$

- Show $\int_0^1 \int_{-1}^1 f(x, y) dx dy$ exists, but $\int_{-1}^1 \int_0^1 f(x, y) dy dx$ does not.
- Compute $\int_{-1}^1 \overline{\int_0^1} f(x, y) dy dx$ and $\int_{-1}^1 \underline{\int_0^1} f(x, y) dy dx$.
- Show f is not Riemann integrable on $[-1, 1] \times [0, 1]$ (use Fubini).

Exercise 10.2.9: Define $f: [0, 1] \times [0, 1] \rightarrow \mathbb{R}$ by

$$f(x, y) := \begin{cases} 1/q & \text{if } x \in \mathbb{Q}, y \in \mathbb{Q}, \text{ and } y = p/q \text{ in lowest terms,} \\ 0 & \text{else.} \end{cases}$$

- Show f is Riemann integrable on $[0, 1] \times [0, 1]$.
- Find $\overline{\int_0^1} f(x, y) dx$ and $\underline{\int_0^1} f(x, y) dx$ for all $y \in [0, 1]$, and show they are unequal for all $y \in \mathbb{Q}$.
- Show $\int_0^1 \int_0^1 f(x, y) dy dx$ exists, but $\int_0^1 \int_0^1 f(x, y) dx dy$ does not.

Note: By Fubini, $\int_0^1 \overline{\int_0^1} f(x, y) dy dx$ and $\int_0^1 \underline{\int_0^1} f(x, y) dy dx$ do exist and equal the integral of f on R .

10.3 Outer measure and null sets

Note: 2 lectures

10.3.1 Outer measure and null sets

Before we characterize all Riemann integrable functions, we need to make a slight detour. We introduce a way of measuring the size of sets in \mathbb{R}^n .

Definition 10.3.1. Let $S \subset \mathbb{R}^n$ be a subset. Define the *outer measure* of S as

$$m^*(S) := \inf \sum_{j=1}^{\infty} V(R_j),$$

where the infimum is taken over all sequences $\{R_j\}$ of open rectangles such that $S \subset \bigcup_{j=1}^{\infty} R_j$. See [Figure 10.4](#). In particular, S is of *measure zero* or a *null set* if $m^*(S) = 0$.

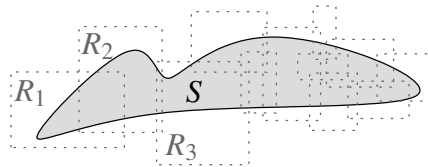

Figure 10.4: Outer measure construction, in this case $S \subset R_1 \cup R_2 \cup R_3 \cup \dots$, so $m^*(S) \leq V(R_1) + V(R_2) + V(R_3) + \dots$.

An immediate consequence ([Exercise 10.3.2](#)) of the definition is that if $A \subset B$, then $m^*(A) \leq m^*(B)$. It is also not difficult to show ([Exercise 10.3.13](#)) that we obtain the same number $m^*(S)$ if we also allow both finite and infinite sequences of rectangles in the definition. It is not enough, however, to allow only finite sequences.

The theory of measures on \mathbb{R}^n is a very complicated subject. We will only require measure-zero sets and so we focus on these. A set S is of measure zero if for every $\varepsilon > 0$ there exists a sequence of open rectangles $\{R_j\}$ such that

$$S \subset \bigcup_{j=1}^{\infty} R_j \quad \text{and} \quad \sum_{j=1}^{\infty} V(R_j) < \varepsilon. \quad (10.2)$$

If S is of measure zero and $S' \subset S$, then S' is of measure zero. We can use the same exact rectangles.

It is sometimes more convenient to use balls instead of rectangles. Furthermore, we can choose balls no bigger than a fixed radius.

Proposition 10.3.2. Let $\delta > 0$ be given. A set $S \subset \mathbb{R}^n$ is of measure zero if and only if for every $\varepsilon > 0$, there exists a sequence of open balls $\{B_j\}$, where the radius of B_j is $r_j < \delta$, and such that

$$S \subset \bigcup_{j=1}^{\infty} B_j \quad \text{and} \quad \sum_{j=1}^{\infty} r_j^n < \varepsilon.$$

Note that the “volume” of B_j is proportional to r_j^n .

Proof. If C is a (closed or open) cube (rectangle with all sides equal) of side s , then C is contained in a closed ball of radius $\sqrt{n}s$ by Proposition 10.1.14, and therefore in an open ball of size $2\sqrt{n}s$.

Suppose R is a (closed or open) rectangle. Let s be a number that is less than the smallest side of R and also so that $2\sqrt{n}s < \delta$. We claim R is contained in a union of closed cubes C_1, C_2, \dots, C_k of sides s such that

$$\sum_{j=1}^k V(C_j) \leq 2^n V(R).$$

It is clearly true (without the 2^n) if R has sides that are integer multiples of s . So if a side is of length $(\ell + \alpha)s$, for $\ell \in \mathbb{N}$ and $0 \leq \alpha < 1$, then $(\ell + \alpha)s \leq 2\ell s$. Increasing the side to $2\ell s$, and then doing the same for every side, we obtain a new larger rectangle of volume at most 2^n times larger, but whose sides are multiples of s .

So suppose that S is a null set and there exist $\{R_j\}$ whose union contains S and such that (10.2) is true. As we have seen above, we can choose closed cubes $\{C_k\}$ with C_k of side s_k as above that cover all the rectangles $\{R_j\}$ and so that

$$\sum_{k=1}^{\infty} s_k^n = \sum_{k=1}^{\infty} V(C_k) \leq 2^n \sum_{j=1}^{\infty} V(R_j) < 2^n \varepsilon.$$

Covering C_k with balls B_k of radius $r_k = 2\sqrt{n}s_k < \delta$ we obtain

$$\sum_{k=1}^{\infty} r_k^n = \sum_{k=1}^{\infty} (2\sqrt{n})^n s_k^n < (4\sqrt{n})^n \varepsilon.$$

And as $S \subset \bigcup_j R_j \subset \bigcup_k C_k \subset \bigcup_k B_k$, we are finished.

For the other direction, suppose S is covered by balls B_j of radii r_j , such that $\sum r_j^n < \varepsilon$, as in the statement of the proposition. Each B_j is contained in a cube R_j of side $2r_j$. So $V(R_j) = (2r_j)^n = 2^n r_j^n$. Therefore,

$$S \subset \bigcup_{j=1}^{\infty} R_j \quad \text{and} \quad \sum_{j=1}^{\infty} V(R_j) \leq \sum_{j=1}^{\infty} 2^n r_j^n < 2^n \varepsilon. \quad \square$$

The definition of outer measure (not just null sets) could have been done with open balls as well. We leave this generalization to the reader.

10.3.2 Examples and basic properties

Example 10.3.3: The set $\mathbb{Q}^n \subset \mathbb{R}^n$ of points with rational coordinates is a set of measure zero.

Proof: The set \mathbb{Q}^n is countable and therefore let us write it as a sequence q_1, q_2, \dots . For each q_j find an open rectangle R_j with $q_j \in R_j$ and $V(R_j) < \varepsilon 2^{-j}$. Then

$$\mathbb{Q}^n \subset \bigcup_{j=1}^{\infty} R_j \quad \text{and} \quad \sum_{j=1}^{\infty} V(R_j) < \sum_{j=1}^{\infty} \varepsilon 2^{-j} = \varepsilon.$$

The example points to a more general result.

Proposition 10.3.4. *A countable union of measure zero sets is of measure zero.*

Proof. Suppose

$$S = \bigcup_{j=1}^{\infty} S_j,$$

where S_j are all measure zero sets. Let $\varepsilon > 0$ be given. For each j there exists a sequence of open rectangles $\{R_{j,k}\}_{k=1}^{\infty}$ such that

$$S_j \subset \bigcup_{k=1}^{\infty} R_{j,k}$$

and

$$\sum_{k=1}^{\infty} V(R_{j,k}) < 2^{-j} \varepsilon.$$

Then

$$S \subset \bigcup_{j=1}^{\infty} \bigcup_{k=1}^{\infty} R_{j,k}.$$

As $V(R_{j,k})$ is always positive, the sum over all j and k can be done in any order. In particular, it can be done as

$$\sum_{j=1}^{\infty} \sum_{k=1}^{\infty} V(R_{j,k}) < \sum_{j=1}^{\infty} 2^{-j} \varepsilon = \varepsilon. \quad \square$$

The next example is not just interesting, it will be useful later.

Example 10.3.5: Let $P := \{x \in \mathbb{R}^n : x_k = c\}$ for a fixed $k = 1, 2, \dots, n$ and a fixed constant $c \in \mathbb{R}$. Then P is of measure zero.

Proof: First fix s and let us prove that

$$P_s := \{x \in \mathbb{R}^n : x_k = c, |x_j| \leq s \text{ for all } j \neq k\}$$

is of measure zero. Given any $\varepsilon > 0$ define the open rectangle

$$R := \{x \in \mathbb{R}^n : c - \varepsilon < x_k < c + \varepsilon, |x_j| < s + 1 \text{ for all } j \neq k\}.$$

It is clear that $P_s \subset R$. Furthermore

$$V(R) = 2\varepsilon(2(s+1))^{n-1}.$$

As s is fixed, we make $V(R)$ arbitrarily small by picking ε small enough. So P_s is measure zero.

Next

$$P = \bigcup_{j=1}^{\infty} P_j$$

and a countable union of measure zero sets is measure zero.

Example 10.3.6: If $a < b$, then $m^*([a, b]) = b - a$.

Proof: In \mathbb{R} , open rectangles are open intervals. Since $[a, b] \subset (a - \varepsilon, b + \varepsilon)$ for all $\varepsilon > 0$. Hence, $m^*([a, b]) \leq b - a$.

Let us prove the other inequality. Suppose $\{(a_j, b_j)\}$ are open intervals such that

$$[a, b] \subset \bigcup_{j=1}^{\infty} (a_j, b_j).$$

We wish to bound $\sum(b_j - a_j)$ from below. Since $[a, b]$ is compact, then finitely many of the open intervals still cover $[a, b]$. As throwing out some of the intervals only makes the sum smaller, we only need to consider the finite number of intervals still covering $[a, b]$. If $(a_i, b_i) \subset (a_j, b_j)$, then we can throw out (a_i, b_i) as well, in other words the intervals that are left have distinct left endpoints, and whenever $a_j < a_i < b_j$, then $b_j < b_i$. Therefore $[a, b] \subset \bigcup_{j=1}^k (a_j, b_j)$ for some k , and we assume that the intervals are sorted such that $a_1 < a_2 < \dots < a_k$. Since (a_2, b_2) is not contained in (a_1, b_1) , since $a_j > a_2$ for all $j > 2$, and since the intervals must contain every point in $[a, b]$, we find that $a_2 < b_1$, or in other words $a_1 < a_2 < b_1 < b_2$. Similarly $a_j < a_{j+1} < b_j < b_{j+1}$. Furthermore, $a_1 < a$ and $b_k > b$. Thus,

$$m^*([a, b]) \geq \sum_{j=1}^k (b_j - a_j) \geq \sum_{j=1}^{k-1} (a_{j+1} - a_j) + (b_k - a_k) = b_k - a_1 > b - a.$$

Proposition 10.3.7. Suppose $E \subset \mathbb{R}^n$ is a compact set of measure zero. Then for every $\varepsilon > 0$, there exist finitely many open rectangles R_1, R_2, \dots, R_k such that

$$E \subset R_1 \cup R_2 \cup \dots \cup R_k \quad \text{and} \quad \sum_{j=1}^k V(R_j) < \varepsilon.$$

Moreover, for every $\varepsilon > 0$ and every $\delta > 0$, there exist finitely many open balls B_1, B_2, \dots, B_ℓ of radii $r_1, r_2, \dots, r_\ell < \delta$ such that

$$E \subset B_1 \cup B_2 \cup \dots \cup B_\ell \quad \text{and} \quad \sum_{j=1}^{\ell} r_j^n < \varepsilon.$$

Proof. As E is of measure zero, there exists a sequence of open rectangles $\{R_j\}$ such that

$$E \subset \bigcup_{j=1}^{\infty} R_j \quad \text{and} \quad \sum_{j=1}^{\infty} V(R_j) < \varepsilon.$$

By compactness, there are finitely many of these rectangles that still contain E . That is, there is some k such that $E \subset R_1 \cup R_2 \cup \dots \cup R_k$. Hence

$$\sum_{j=1}^k V(R_j) \leq \sum_{j=1}^{\infty} V(R_j) < \varepsilon.$$

The proof that we can choose balls instead of rectangles is left as an exercise. □

Example 10.3.8: So that the reader is not under the impression that there are only few measure zero sets and that these sets are uncomplicated, let us give an uncountable, compact, measure zero subset of $[0, 1]$. For every $x \in [0, 1]$, write its representation in ternary notation

$$x = \sum_{n=1}^{\infty} d_n 3^{-n}, \quad \text{where } d_n = 0, 1, \text{ or } 2.$$

See §1.5 in volume I, in particular Exercise 1.5.4. Define the *Cantor set* C as

$$C := \left\{ x \in [0, 1] : x = \sum_{n=1}^{\infty} d_n 3^{-n}, \text{ where } d_n = 0 \text{ or } d_n = 2 \text{ for all } n \right\}.$$

That is, x is in C if it has a ternary expansion in only 0s and 2s. If x has two expansions, as long as one of them does not have any 1s, then x is in C . Define $C_0 := [0, 1]$ and

$$C_k := \left\{ x \in [0, 1] : x = \sum_{n=1}^{\infty} d_n 3^{-n}, \text{ where } d_n = 0 \text{ or } d_n = 2 \text{ for all } n = 1, 2, \dots, k \right\}.$$

Clearly,

$$C = \bigcap_{k=1}^{\infty} C_k.$$

See [Figure 10.5](#).

We leave as an exercise to prove that

- (i) Each C_k is a finite union of closed intervals. It is obtained by taking C_{k-1} , and from each closed interval removing the “middle third.”
- (ii) Each C_k is closed, and so C is closed.
- (iii) $m^*(C_k) = 1 - \sum_{n=1}^k \frac{2^n}{3^{n+1}}$.
- (iv) Hence, $m^*(C) = 0$.
- (v) The set C is in one-to-one correspondence with $[0, 1]$, in other words, C is uncountable.

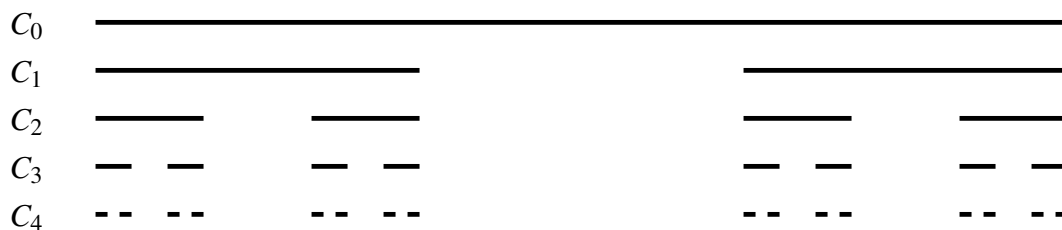

Figure 10.5: Cantor set construction.

10.3.3 Images of null sets under differentiable functions

Before we look at images of measure zero sets, let us see what a continuously differentiable function does to a ball.

Lemma 10.3.9. *Suppose $U \subset \mathbb{R}^n$ is an open set, $B \subset U$ is an open (resp. closed) ball of radius at most r , $f: B \rightarrow \mathbb{R}^n$ is continuously differentiable and suppose $\|f'(x)\| \leq M$ for all $x \in B$. Then $f(B) \subset B'$, where B' is an open (resp. closed) ball of radius at most Mr .*

Proof. First suppose B is closed. The ball B is convex, and so via [Proposition 8.4.2](#), $\|f(x) - f(y)\| \leq M\|x - y\|$ for all x, y in B . In particular, suppose $B = C(y, r)$, then $f(B) \subset C(f(y), Mr)$. If B is open, let $C := C(y, r - \varepsilon)$ for $\varepsilon > 0$ be a closed ball. Then $f(C) \subset C(f(y), M(r - \varepsilon)) \subset B(f(y), Mr)$. As every $x \in B$ is in C for some $\varepsilon > 0$, $f(B) \subset B(f(y), Mr)$. \square

The image of a measure zero set using a continuous map is not necessarily a measure zero set, although this is not easy to show (see the exercises). However, if the mapping is continuously differentiable, then the mapping cannot “stretch” the set that much.

Proposition 10.3.10. *Suppose $U \subset \mathbb{R}^n$ is an open set and $f: U \rightarrow \mathbb{R}^n$ is a continuously differentiable mapping. If $E \subset U$ is a measure zero set, then $f(E)$ is measure zero.*

Proof. We prove the proposition for a compact E and leave the general case as an exercise.

Suppose E is compact and of measure zero. First, we replace U by a smaller open set to make $\|f'(x)\|$ bounded. At each point $x \in E$ pick an open ball $B(x, r_x)$ such that the closed ball $C(x, r_x) \subset U$. By compactness we only need to take finitely many points x_1, x_2, \dots, x_q to cover E with the balls $B(x_j, r_{x_j})$. Define

$$U' := \bigcup_{j=1}^q B(x_j, r_{x_j}), \quad K := \bigcup_{j=1}^q C(x_j, r_{x_j}).$$

We have $E \subset U' \subset K \subset U$. The set K is compact. The function that takes x to $\|f'(x)\|$ is continuous, and therefore there exists an $M > 0$ such that $\|f'(x)\| \leq M$ for all $x \in K$. So without loss of generality we may replace U by U' and from now on suppose that $\|f'(x)\| \leq M$ for all $x \in U$.

At each $x \in E$ take the maximum radius δ_x such that $B(x, \delta_x) \subset U$ (we may assume $U \neq \mathbb{R}^n$). Let $\delta := \inf_{x \in E} \delta_x$. Take a sequence $\{x_j\} \subset E$ so that $\delta_{x_j} \rightarrow \delta$. As E is compact, we can pick the sequence to be convergent to some $y \in E$. Once $\|x_j - y\| < \frac{\delta_y}{2}$, then $\delta_{x_j} > \frac{\delta_y}{2}$ by the triangle inequality. Thus, $\delta > 0$.

Given $\varepsilon > 0$, there exist balls B_1, B_2, \dots, B_k of radii $r_1, r_2, \dots, r_k < \delta$ such that

$$E \subset B_1 \cup B_2 \cup \dots \cup B_k \quad \text{and} \quad \sum_{j=1}^k r_j^n < \varepsilon.$$

The balls are contained in U . Suppose B'_1, B'_2, \dots, B'_k are the balls of radius Mr_1, Mr_2, \dots, Mr_k from [Lemma 10.3.9](#), such that $f(B_j) \subset B'_j$ for all j . Then,

$$f(E) \subset f(B_1) \cup f(B_2) \cup \dots \cup f(B_k) \subset B'_1 \cup B'_2 \cup \dots \cup B'_k \quad \text{and} \quad \sum_{j=1}^k Mr_j^n < M\varepsilon. \quad \square$$

10.3.4 Exercises

Exercise 10.3.1: Finish the proof of [Proposition 10.3.7](#), that is, show that you can use balls instead of rectangles.

Exercise 10.3.2: If $A \subset B$, then $m^*(A) \leq m^*(B)$.

Exercise 10.3.3: Suppose $X \subset \mathbb{R}^n$ is a set such that for every $\varepsilon > 0$ there exists a set Y such that $X \subset Y$ and $m^*(Y) \leq \varepsilon$. Prove that X is a measure zero set.

Exercise 10.3.4: Show that if $R \subset \mathbb{R}^n$ is a closed rectangle, then $m^*(R) = V(R)$.

Exercise 10.3.5: The closure of a measure zero set can be quite large. Find an example set $S \subset \mathbb{R}^n$ that is of measure zero, but whose closure $\bar{S} = \mathbb{R}^n$.

Exercise 10.3.6: Prove the general case of [Proposition 10.3.10](#) without using compactness:

a) Mimic the proof to first prove that the proposition holds if E is relatively compact; a set $E \subset U$ is relatively compact if the closure of E in the subspace topology on U is compact, or in other words if there exists a compact set K with $K \subset U$ and $E \subset K$.

Hint: The bound on the size of the derivative still holds, but you need to use countably many balls in the second part of the proof. Be careful as the closure of E need no longer be measure zero.

b) Now prove it for every null set E .

Hint: First show that $\{x \in U : d(x, y) \geq 1/m \text{ for all } y \notin U \text{ and } d(0, x) \leq m\}$ is a compact set for every $m > 0$.

Exercise 10.3.7: Let $U \subset \mathbb{R}^n$ be an open set and let $f: U \rightarrow \mathbb{R}$ be a continuously differentiable function. Let $G := \{(x, y) \in U \times \mathbb{R} : y = f(x)\}$ be the graph of f . Show that f is of measure zero.

Exercise 10.3.8: Given a closed rectangle $R \subset \mathbb{R}^n$, show that for every $\varepsilon > 0$, there exists a number $s > 0$ and finitely many open cubes C_1, C_2, \dots, C_k of side s such that $R \subset C_1 \cup C_2 \cup \dots \cup C_k$ and

$$\sum_{j=1}^k V(C_j) \leq V(R) + \varepsilon.$$

Exercise 10.3.9: Show that there exists a number $k = k(n, r, \delta)$ depending only on n , r and δ such the following holds. Given $B(x, r) \subset \mathbb{R}^n$ and $\delta > 0$, there exist k open balls B_1, B_2, \dots, B_k of radius at most δ such that $B(x, r) \subset B_1 \cup B_2 \cup \dots \cup B_k$. Note that you can find k that really only depends on n and the ratio δ/r .

Exercise 10.3.10 (Challenging): Prove the statements of [Example 10.3.8](#). That is, prove:

a) Each C_k is a finite union of closed intervals, and so C is closed.

b) $m^*(C_k) = 1 - \sum_{n=1}^k \frac{2^n}{3^{n+1}}$.

c) $m^*(C) = 0$.

d) The set C is in one-to-one correspondence with $[0, 1]$.

Exercise 10.3.11: Prove that the Cantor set of [Example 10.3.8](#) contains no interval. That is, whenever $a < b$, there exists a point $x \notin C$ such that $a < x < b$.

Note a consequence of this statement. While every open set in \mathbb{R} is a countable disjoint union of intervals, a closed set (even though it is just the complement of an open set) need not be a union of intervals.

Exercise 10.3.12 (Challenging): Let us construct the so-called Cantor function or the Devil's staircase. Let C be the Cantor set and let C_k be as in Example 10.3.8. Write $x \in [0, 1]$ in ternary representation $x = \sum_{n=1}^{\infty} d_n 3^{-n}$. If $d_n \neq 1$ for all n , then let $c_n := \frac{d_n}{2}$ for all n . Otherwise, let k be the smallest integer such that $d_k = 1$. Then let $c_n := \frac{d_n}{2}$ if $n < k$, $c_k := 1$, and $c_n := 0$ if $n > k$. Then define

$$\varphi(x) := \sum_{n=1}^{\infty} c_n 2^{-n}.$$

- Prove that φ is continuous and increasing (see Figure 10.5).
- Prove that for $x \notin C$, φ is differentiable at x and $\varphi'(x) = 0$. (Notice that φ' exists and is zero except for a set of measure zero, yet the function manages to climb from 0 to 1.)
- Define $\psi: [0, 1] \rightarrow [0, 2]$ by $\psi(x) := \varphi(x) + x$. Show that ψ is continuous, strictly increasing, and bijective.
- Prove that while $m^*(C) = 0$, $m^*(\psi(C)) \neq 0$. That is, continuous functions need take measure zero sets to measure zero sets. Hint: $m^*(\psi([0, 1] \setminus C)) = 1$, but $m^*([0, 2]) = 2$.

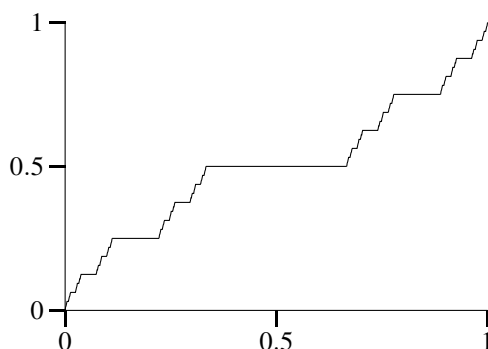

Figure 10.6: Cantor function or Devil's staircase (the function φ from the exercise).

Exercise 10.3.13: Prove that we obtain the same outer measure if we allow both finite and infinite sequences in the definition. That is, define $\mu^*(S) := \inf \sum_{j \in I} V(R_j)$ where the infimum is taken over all countable (finite or infinite) sets of open rectangles $\{R_j\}_{j \in I}$ such that $S \subset \bigcup_{j \in I} R_j$. Prove that for every $S \subset \mathbb{R}^n$, $\mu^*(S) = m^*(S)$.

10.4 The set of Riemann integrable functions

Note: 1 lecture

10.4.1 Oscillation and continuity

Consider $S \subset \mathbb{R}^n$ and $f: S \rightarrow \mathbb{R}$. Instead of just saying that f is or is not continuous at a point $x \in S$, we want to quantify how discontinuous f is at x . For every $\delta > 0$, define the *oscillation* of f on the δ -ball in subspace topology, $B_S(x, \delta) = B_{\mathbb{R}^n}(x, \delta) \cap S$, as

$$o(f, x, \delta) := \sup_{y \in B_S(x, \delta)} f(y) - \inf_{y \in B_S(x, \delta)} f(y) = \sup_{y_1, y_2 \in B_S(x, \delta)} (f(y_1) - f(y_2)).$$

That is, $o(f, x, \delta)$ is the length of the smallest interval that contains the image $f(B_S(x, \delta))$. Clearly $o(f, x, \delta) \geq 0$ and $o(f, x, \delta) \leq o(f, x, \delta')$ whenever $\delta < \delta'$. Therefore, the limit as $\delta \rightarrow 0$ from the right exists, and we define the *oscillation* of f at x as

$$o(f, x) := \lim_{\delta \rightarrow 0^+} o(f, x, \delta) = \inf_{\delta > 0} o(f, x, \delta).$$

Proposition 10.4.1. *A function $f: S \rightarrow \mathbb{R}$ is continuous at $x \in S$ if and only if $o(f, x) = 0$.*

Proof. First suppose that f is continuous at $x \in S$. Given any $\varepsilon > 0$, there exists a $\delta > 0$ such that for $y \in B_S(x, \delta)$, we have $|f(x) - f(y)| < \varepsilon$. Therefore, if $y_1, y_2 \in B_S(x, \delta)$, then

$$f(y_1) - f(y_2) = (f(y_1) - f(x)) - (f(y_2) - f(x)) < \varepsilon + \varepsilon = 2\varepsilon.$$

We take the supremum over y_1 and y_2

$$o(f, x, \delta) = \sup_{y_1, y_2 \in B_S(x, \delta)} (f(y_1) - f(y_2)) \leq 2\varepsilon.$$

As $o(x, f) \leq o(f, x, \delta) \leq 2\varepsilon$, and $\varepsilon > 0$ was arbitrary, $o(x, f) = 0$.

On the other hand suppose $o(x, f) = 0$. Given any $\varepsilon > 0$, find a $\delta > 0$ such that $o(f, x, \delta) < \varepsilon$. If $y \in B_S(x, \delta)$, then

$$|f(x) - f(y)| \leq \sup_{y_1, y_2 \in B_S(x, \delta)} (f(y_1) - f(y_2)) = o(f, x, \delta) < \varepsilon. \quad \square$$

Proposition 10.4.2. *Let $S \subset \mathbb{R}^n$ be closed, $f: S \rightarrow \mathbb{R}$, and $\varepsilon > 0$. The set $\{x \in S : o(f, x) \geq \varepsilon\}$ is closed.*

Proof. Equivalently, we want to show that $G = \{x \in S : o(f, x) < \varepsilon\}$ is open in the subspace topology. As $\inf_{\delta > 0} o(f, x, \delta) < \varepsilon$, find a $\delta > 0$ such that

$$o(f, x, \delta) < \varepsilon$$

Take any $\xi \in B_S(x, \delta/2)$. Notice that $B_S(\xi, \delta/2) \subset B_S(x, \delta)$. Therefore,

$$o(f, \xi, \delta/2) = \sup_{y_1, y_2 \in B_S(\xi, \delta/2)} (f(y_1) - f(y_2)) \leq \sup_{y_1, y_2 \in B_S(x, \delta)} (f(y_1) - f(y_2)) = o(f, x, \delta) < \varepsilon.$$

So $o(f, \xi) < \varepsilon$ as well. As this is true for all $\xi \in B_S(x, \delta/2)$, we get that G is open in the subspace topology and $S \setminus G$ is closed as claimed. \square

10.4.2 The set of Riemann integrable functions

We have seen that continuous functions are Riemann integrable, but we also know that certain kinds of discontinuities are allowed. It turns out that as long as the discontinuities happen on a set of measure zero, the function is integrable, and vice versa.

Theorem 10.4.3 (Riemann–Lebesgue). *Let $R \subset \mathbb{R}^n$ be a closed rectangle and $f: R \rightarrow \mathbb{R}$ a bounded function. Then f is Riemann integrable if and only if the set of discontinuities of f is of measure zero (a null set).*

Proof. Let $S \subset R$ be the set of discontinuities of f , that is, $S = \{x \in R : o(f, x) > 0\}$. Suppose S is a measure zero set: $m^*(S) = 0$. The trick to this proof is to isolate the bad set into a small set of subrectangles of a partition. There are only finitely many subrectangles of a partition, so we will wish to use compactness. If S were closed, then it would be compact and we could cover it by finitely many small rectangles as it is of measure zero. Unfortunately, S is not closed in general, so we need to work a little harder.

For every $\varepsilon > 0$, define

$$S_\varepsilon := \{x \in R : o(f, x) \geq \varepsilon\}.$$

By [Proposition 10.4.2](#), S_ε is closed and as it is a subset of R , which is bounded, S_ε is compact. Furthermore, $S_\varepsilon \subset S$ and S is of measure zero, so S_ε is measure zero. Via [Proposition 10.3.7](#) finitely many open rectangles O_1, O_2, \dots, O_k cover S_ε and $\sum V(O_j) < \varepsilon$.

The set $T = R \setminus (O_1 \cup \dots \cup O_k)$ is closed, bounded, and therefore compact. Furthermore, $o(f, x) < \varepsilon$ for all $x \in T$. Hence for each $x \in T$, there exists a small closed rectangle T_x with x in the interior of T_x , such that

$$\sup_{y \in T_x} f(y) - \inf_{y \in T_x} f(y) < 2\varepsilon.$$

The interiors of the rectangles T_x cover T . As T is compact, finitely many such rectangles T_1, T_2, \dots, T_m cover T .

Take the rectangles T_1, T_2, \dots, T_m and O_1, O_2, \dots, O_k and construct a partition out of their endpoints. That is, construct a partition P of R with subrectangles R_1, R_2, \dots, R_p such that every R_j is contained in T_ℓ for some ℓ or the closure of O_ℓ for some ℓ . Order the rectangles so that R_1, R_2, \dots, R_q are those that are contained in some T_ℓ , and $R_{q+1}, R_{q+2}, \dots, R_p$ are the rest. In particular,

$$\sum_{j=1}^q V(R_j) \leq V(R) \quad \text{and} \quad \sum_{j=q+1}^p V(R_j) \leq \varepsilon.$$

Let m_j and M_j be the inf and sup of f over R_j as before. If $R_j \subset T_\ell$ for some ℓ , then $(M_j - m_j) < 2\varepsilon$. Let $B \in \mathbb{R}$ be such that $|f(x)| \leq B$ for all $x \in R$, so $(M_j - m_j) < 2B$ over all rectangles. Then

$$\begin{aligned} U(P, f) - L(P, f) &= \sum_{j=1}^p (M_j - m_j)V(R_j) \\ &= \left(\sum_{j=1}^q (M_j - m_j)V(R_j) \right) + \left(\sum_{j=q+1}^p (M_j - m_j)V(R_j) \right) \\ &\leq \left(\sum_{j=1}^q 2\varepsilon V(R_j) \right) + \left(\sum_{j=q+1}^p 2BV(R_j) \right) \\ &\leq 2\varepsilon V(R) + 2B\varepsilon = \varepsilon(2V(R) + 2B). \end{aligned}$$

We can make the right-hand side as small as we want, and hence f is integrable.

For the other direction, suppose f is Riemann integrable on R . Let S be the set of discontinuities again. Consider the sequence of sets

$$S_{1/k} = \{x \in R : o(f, x) \geq 1/k\}.$$

Fix a $k \in \mathbb{N}$. Given an $\varepsilon > 0$, find a partition P with subrectangles R_1, R_2, \dots, R_p such that

$$U(P, f) - L(P, f) = \sum_{j=1}^p (M_j - m_j)V(R_j) < \varepsilon$$

Suppose R_1, R_2, \dots, R_p are ordered so that the interiors of R_1, R_2, \dots, R_q intersect $S_{1/k}$, while the interiors of $R_{q+1}, R_{q+2}, \dots, R_p$ are disjoint from $S_{1/k}$. If $x \in R_j \cap S_{1/k}$ and x is in the interior of R_j , then by definition of $S_{1/k}$ we have $M_j - m_j \geq 1/k$. Then

$$\varepsilon > \sum_{j=1}^p (M_j - m_j)V(R_j) \geq \sum_{j=1}^q (M_j - m_j)V(R_j) \geq \frac{1}{k} \sum_{j=1}^q V(R_j)$$

In other words, $\sum_{j=1}^q V(R_j) < k\varepsilon$. Let G be the set of all boundaries of all the subrectangles of P . The set G is of measure zero (see [Example 10.3.5](#)). Let R_j° denote the interior of R_j , then

$$S_{1/k} \subset R_1^\circ \cup R_2^\circ \cup \dots \cup R_q^\circ \cup G.$$

As G can be covered by open rectangles arbitrarily small volume, $S_{1/k}$ must be of measure zero. As

$$S = \bigcup_{k=1}^{\infty} S_{1/k}$$

and a countable union of measure zero sets is of measure zero, S is of measure zero. \square

Corollary 10.4.4. *Let $R \subset \mathbb{R}^n$ be a closed rectangle. Let $\mathcal{R}(R)$ be the set of Riemann integrable functions on R . Then*

(i) $\mathcal{R}(R)$ is a real algebra: If $f, g \in \mathcal{R}(R)$ and $a \in \mathbb{R}$, then $af \in \mathcal{R}(R)$, $f + g \in \mathcal{R}(R)$ and $fg \in \mathcal{R}(R)$.

(ii) If $f, g \in \mathcal{R}(R)$ and

$$\varphi(x) := \max\{f(x), g(x)\}, \quad \psi(x) := \min\{f(x), g(x)\},$$

then $\varphi, \psi \in \mathcal{R}(R)$.

(iii) If $f \in \mathcal{R}(R)$, then $|f| \in \mathcal{R}(R)$, where $|f|(x) := |f(x)|$.

(iv) If $R' \subset \mathbb{R}^m$ is another closed rectangle, $U \subset \mathbb{R}^n$ and $U' \subset \mathbb{R}^m$ are open sets such that $R \subset U$ and $R' \subset U'$, $g: U \rightarrow U'$ is continuously differentiable, bijective, g^{-1} is continuously differentiable, and $f \in \mathcal{R}(R')$, then the composition $f \circ g$ is Riemann integrable on R .

The proof is contained in the exercises.

10.4.3 Exercises

Exercise 10.4.1: Suppose $f: (a, b) \times (c, d) \rightarrow \mathbb{R}$ is a bounded continuous function. Show that the integral of f over $R = [a, b] \times [c, d]$ makes sense and is uniquely defined. That is, set f to be anything on the boundary of R and compute the integral, showing that the values on the boundary are irrelevant.

Exercise 10.4.2: Suppose $R \subset \mathbb{R}^n$ is a closed rectangle. Show that $\mathcal{R}(R)$, the set of Riemann integrable functions, is an algebra. That is, show that if $f, g \in \mathcal{R}(R)$ and $a \in \mathbb{R}$, then $af \in \mathcal{R}(R)$, $f + g \in \mathcal{R}(R)$, and $fg \in \mathcal{R}(R)$.

Exercise 10.4.3: Suppose $R \subset \mathbb{R}^n$ is a closed rectangle and $f: R \rightarrow \mathbb{R}$ is a bounded function which is zero except on a closed set $E \subset R$ of measure zero. Show that $\int_R f$ exists and compute it.

Exercise 10.4.4: Suppose $R \subset \mathbb{R}^n$ is a closed rectangle and $f: R \rightarrow \mathbb{R}$ and $g: R \rightarrow \mathbb{R}$ are two Riemann integrable functions. Suppose $f = g$ except for a closed set $E \subset R$ of measure zero. Show that $\int_R f = \int_R g$.

Exercise 10.4.5: Suppose $R \subset \mathbb{R}^n$ is a closed rectangle and $f: R \rightarrow \mathbb{R}$ is a bounded function.

- Suppose there exists a closed set $E \subset R$ of measure zero such that $f|_{R \setminus E}$ is continuous. Then $f \in \mathcal{R}(R)$.
- Find an example where $E \subset R$ is a set of measure zero (not closed) such that $f|_{R \setminus E}$ is continuous and $f \notin \mathcal{R}(R)$.

Exercise 10.4.6: Suppose $R \subset \mathbb{R}^n$ is a closed rectangle and $f: R \rightarrow \mathbb{R}$ and $g: R \rightarrow \mathbb{R}$ are Riemann integrable. Show that

$$\varphi(x) := \max\{f(x), g(x)\}, \quad \psi(x) := \min\{f(x), g(x)\},$$

are Riemann integrable.

Exercise 10.4.7: Suppose $R \subset \mathbb{R}^n$ is a closed rectangle and $f: R \rightarrow \mathbb{R}$ is Riemann integrable. Show that $|f|$ is Riemann integrable. Hint: Define $f_+(x) := \max\{f(x), 0\}$ and $f_-(x) := \max\{-f(x), 0\}$, and then write $|f|$ in terms of f_+ and f_- .

Exercise 10.4.8:

- Suppose $R \subset \mathbb{R}^n$ and $R' \subset \mathbb{R}^m$ are closed rectangles, $U \subset \mathbb{R}^n$ and $U' \subset \mathbb{R}^m$ are open sets such that $R \subset U$ and $R' \subset U'$, $g: U \rightarrow U'$ is continuously differentiable, bijective, g^{-1} is continuously differentiable, and $f \in \mathcal{R}(R')$, then the composition $f \circ g$ is Riemann integrable on R .
- Find a counterexample when g is not one-to-one. Hint: Try $g(x, y) := (x, 0)$ and $R = R' = [0, 1] \times [0, 1]$.

Exercise 10.4.9: Suppose $f: [0, 1]^2 \rightarrow \mathbb{R}$ is defined by

$$f(x, y) := \begin{cases} \frac{1}{kq} & \text{if } x, y \in \mathbb{Q} \text{ and } x = \frac{\ell}{k} \text{ and } y = \frac{p}{q} \text{ in lowest terms,} \\ 0 & \text{else.} \end{cases}$$

Show that $f \in \mathcal{R}([0, 1]^2)$.

Exercise 10.4.10: Compute the oscillation $o(f, (x, y))$ for all $(x, y) \in \mathbb{R}^2$ for the function

$$f(x, y) := \begin{cases} \frac{xy}{x^2+y^2} & \text{if } (x, y) \neq (0, 0), \\ 0 & \text{if } (x, y) = (0, 0). \end{cases}$$

Exercise 10.4.11: Consider the popcorn function $f: [0, 1] \rightarrow \mathbb{R}$,

$$f(x) := \begin{cases} \frac{1}{q} & \text{if } x \in \mathbb{Q} \text{ and } x = \frac{p}{q} \text{ in lowest terms,} \\ 0 & \text{else.} \end{cases}$$

Compute $o(f, x)$ for all $x \in [0, 1]$.

10.5 Jordan measurable sets

Note: 1 lecture

10.5.1 Volume and Jordan measurable sets

Given a set $S \subset \mathbb{R}^n$, its *characteristic function* or *indicator function* $\chi_S: \mathbb{R}^n \rightarrow \mathbb{R}$ is defined by

$$\chi_S(x) := \begin{cases} 1 & \text{if } x \in S, \\ 0 & \text{if } x \notin S. \end{cases}$$

A bounded set S is *Jordan measurable** if for some closed rectangle R such that $S \subset R$, the function χ_S is Riemann integrable, that is, $\chi_S \in \mathcal{R}(R)$. Take two closed rectangles R and R' with $S \subset R$ and $S \subset R'$, then $R \cap R'$ is a closed rectangle also containing S . By [Proposition 10.1.13](#) and [Exercise 10.1.7](#), $\chi_S \in \mathcal{R}(R \cap R')$ and so $\chi_S \in \mathcal{R}(R')$. Thus

$$\int_R \chi_S = \int_{R'} \chi_S = \int_{R \cap R'} \chi_S.$$

We define the *n-dimensional volume* of the bounded Jordan measurable set S as

$$V(S) := \int_R \chi_S,$$

where R is any closed rectangle containing S .

Proposition 10.5.1. *A bounded set $S \subset \mathbb{R}^n$ is Jordan measurable if and only if the boundary ∂S is a measure zero set.*

Proof. Suppose R is a closed rectangle such that S is contained in the interior of R . If $x \in \partial S$, then for every $\delta > 0$, the sets $S \cap B(x, \delta)$ (where χ_S is 1) and the sets $(R \setminus S) \cap B(x, \delta)$ (where χ_S is 0) are both nonempty. So χ_S is not continuous at x . If x is either in the interior of S or in the complement of the closure \bar{S} , then χ_S is either identically 1 or identically 0 in a whole neighborhood of x and hence χ_S is continuous at x . Therefore, the set of discontinuities of χ_S is precisely the boundary ∂S . The proposition follows. \square

Proposition 10.5.2. *Suppose S and T are bounded Jordan measurable sets. Then*

- (i) *The closure \bar{S} is Jordan measurable.*
- (ii) *The interior S° is Jordan measurable.*
- (iii) *$S \cup T$ is Jordan measurable.*
- (iv) *$S \cap T$ is Jordan measurable.*
- (v) *$S \setminus T$ is Jordan measurable.*

The proof of the proposition is left as an exercise. Next, we find that the volume that we defined above coincides with the outer measure we defined above.

*Named after the French mathematician [Marie Ennemond Camille Jordan](#) (1838–1922).

Proposition 10.5.3. *If $S \subset \mathbb{R}^n$ is Jordan measurable, then $V(S) = m^*(S)$.*

Proof. Given $\varepsilon > 0$, let R be a closed rectangle that contains S . Let P be a partition of R such that

$$U(P, \chi_S) \leq \left(\int_R \chi_S \right) + \varepsilon = V(S) + \varepsilon \quad \text{and} \quad L(P, \chi_S) \geq \left(\int_R \chi_S \right) - \varepsilon = V(S) - \varepsilon.$$

Let R_1, R_2, \dots, R_k be all the subrectangles of P such that χ_S is not identically zero on each R_j . That is, there is some point $x \in R_j$ such that $x \in S$. Let O_j be an open rectangle such that $R_j \subset O_j$ and $V(O_j) < V(R_j) + \varepsilon/k$. Notice that $S \subset \bigcup_j O_j$. Then

$$U(P, \chi_S) = \sum_{j=1}^k V(R_j) > \left(\sum_{j=1}^k V(O_j) \right) - \varepsilon \geq m^*(S) - \varepsilon.$$

As $U(P, \chi_S) \leq V(S) + \varepsilon$, then $m^*(S) - \varepsilon \leq V(S) + \varepsilon$, or in other words $m^*(S) \leq V(S)$.

Let $R'_1, R'_2, \dots, R'_\ell$ be all the subrectangles of P such that χ_S is identically one on each R'_j . In other words, these are the subrectangles contained in S . The interiors of the subrectangles R'_j are disjoint and $V(R'_j) = V(R'_j)$. It is easy to see from definition that

$$m^*\left(\bigcup_{j=1}^{\ell} R'_j\right) = \sum_{j=1}^{\ell} V(R'_j).$$

Hence

$$m^*(S) \geq m^*\left(\bigcup_{j=1}^{\ell} R'_j\right) \geq m^*\left(\bigcup_{j=1}^{\ell} R'_j\right) = \sum_{j=1}^{\ell} V(R'_j) = \sum_{j=1}^{\ell} V(R'_j) = L(P, f) \geq V(S) - \varepsilon.$$

Therefore $m^*(S) \geq V(S)$ as well. □

10.5.2 Integration over Jordan measurable sets

In \mathbb{R} there is only one reasonable type of set to integrate over: an interval. In \mathbb{R}^n there are many kinds of sets. The ones that work with the Riemann integral are the Jordan measurable sets.

Definition 10.5.4. Let $S \subset \mathbb{R}^n$ be a bounded Jordan measurable set. A bounded function $f: S \rightarrow \mathbb{R}$ is said to be *Riemann integrable on S* , or $f \in \mathcal{R}(S)$, if for a closed rectangle R such that $S \subset R$, the function $\tilde{f}: R \rightarrow \mathbb{R}$ defined by

$$\tilde{f}(x) := \begin{cases} f(x) & \text{if } x \in S, \\ 0 & \text{otherwise,} \end{cases}$$

is in $\mathcal{R}(R)$. In this case we write

$$\int_S f := \int_R \tilde{f}.$$

When f is defined on a larger set and we wish to integrate over S , then we apply the definition to the restriction $f|_S$. In particular, if $f: R \rightarrow \mathbb{R}$ for a closed rectangle R , and $S \subset R$ is a Jordan measurable subset, then

$$\int_S f = \int_R f \chi_S.$$

Proposition 10.5.5. *If $S \subset \mathbb{R}^n$ is a bounded Jordan measurable set and $f: S \rightarrow \mathbb{R}$ is a bounded continuous function, then f is integrable on S .*

Proof. Define the function \tilde{f} as above for some closed rectangle R with $S \subset R$. If $x \in R \setminus \bar{S}$, then \tilde{f} is identically zero in a neighborhood of x . Similarly if x is in the interior of S , then $\tilde{f} = f$ on a neighborhood of x and f is continuous at x . Therefore, \tilde{f} is only ever possibly discontinuous at ∂S , which is a set of measure zero, and we are finished. \square

10.5.3 Images of Jordan measurable subsets

Finally, images of Jordan measurable sets are Jordan measurable under nice enough mappings. For simplicity, we assume that the Jacobian determinant never vanishes.

Proposition 10.5.6. *Suppose $U \subset \mathbb{R}^n$ is open and $S \subset U$ is a closed bounded Jordan measurable set. Suppose $g: U \rightarrow \mathbb{R}^n$ is a one-to-one continuously differentiable mapping such that the Jacobian determinant J_g is never zero on S . Then $g(S)$ is bounded and Jordan measurable.*

Proof. Let $T := g(S)$. As $S \subset \mathbb{R}^n$ is closed and bounded it is compact. By Lemma 7.5.5 from volume I, the set T is also compact and so closed and bounded. We claim $\partial T \subset g(\partial S)$. Suppose the claim is proved. As S is Jordan measurable, then ∂S is measure zero. Then $g(\partial S)$ is measure zero by Proposition 10.3.10. As $\partial T \subset g(\partial S)$, then T is Jordan measurable.

It is therefore left to prove the claim. As T is closed, $\partial T \subset T$. Suppose $y \in \partial T$, then there must exist an $x \in S$ such that $g(x) = y$, and by hypothesis $J_g(x) \neq 0$. We use the inverse function theorem (Theorem 8.5.1). We find a neighborhood $V \subset U$ of x and an open set W such that the restriction $f|_V$ is a one-to-one and onto function from V to W with a continuously differentiable inverse. In particular, $g(x) = y \in W$. As $y \in \partial T$, there exists a sequence $\{y_k\}$ in W with $\lim y_k = y$ and $y_k \notin T$. As $g|_V$ is invertible and in particular has a continuous inverse, there exists a sequence $\{x_k\}$ in V such that $g(x_k) = y_k$ and $\lim x_k = x$. Since $y_k \notin T = g(S)$, clearly $x_k \notin S$. Since $x \in S$, we conclude that $x \in \partial S$. The claim is proved, $\partial T \subset g(\partial S)$. \square

10.5.4 Exercises

Exercise 10.5.1: Prove Proposition 10.5.2.

Exercise 10.5.2: Prove that a bounded convex set is Jordan measurable. Hint: Induction on dimension.

Exercise 10.5.3: Let $f: [a, b] \rightarrow \mathbb{R}$ and $g: [a, b] \rightarrow \mathbb{R}$ be continuous functions and such that for all $x \in (a, b)$, $f(x) < g(x)$. Let

$$U := \{(x, y) \in \mathbb{R}^2 : a < x < b \text{ and } f(x) < y < g(x)\}.$$

a) Show that U is Jordan measurable.

b) If $\varphi: U \rightarrow \mathbb{R}$ is Riemann integrable on U , then

$$\int_U \varphi = \int_a^b \int_{g(x)}^{f(x)} \varphi(x, y) dy dx.$$

Exercise 10.5.4: Let us construct an example of a non-Jordan measurable open set. Start in one dimension. Let $\{r_j\}$ be an enumeration of all rational numbers in $(0,1)$. Let (a_j, b_j) be open intervals such that $(a_j, b_j) \subset (0,1)$ for all j , $r_j \in (a_j, b_j)$, and $\sum_{j=1}^{\infty} (b_j - a_j) < 1/2$. Now let $U := \bigcup_{j=1}^{\infty} (a_j, b_j)$.

- Show the open intervals (a_j, b_j) as above actually exist.
- Prove $\partial U = [0,1] \setminus U$.
- Prove ∂U is not of measure zero, and therefore U is not Jordan measurable.
- Show that $W := (U \times (0,2)) \cup ((0,1) \times (1,2))$ is a connected bounded open set in \mathbb{R}^2 that is not Jordan measurable.

Exercise 10.5.5: Suppose $K \subset \mathbb{R}^n$ is a closed measure zero set.

- If K is bounded, prove that K is Jordan measurable.
- If $S \subset \mathbb{R}^n$ is bounded and Jordan measurable, prove that $S \setminus K$ is Jordan measurable.
- Construct a bounded Jordan measurable $S \subset \mathbb{R}^n$ and a bounded $T \subset \mathbb{R}^n$ of measure zero, such that neither T nor $S \setminus T$ is Jordan measurable.

Exercise 10.5.6: Suppose $U \subset \mathbb{R}^n$ is open and $K \subset U$ is compact. Find a compact Jordan measurable set S such that $S \subset U$ and $K \subset S^\circ$ (K is in the interior of S).

Exercise 10.5.7: Prove a version of [Corollary 10.4.4](#), replacing all closed rectangles with bounded Jordan measurable sets.

10.6 Green's theorem

Note: 1 lecture, requires [chapter 9](#)

One of the most important theorems of analysis in several variables is the so-called generalized Stokes' theorem, a generalization of the fundamental theorem of calculus. The two-dimensional version is called Green's theorem*. We will state the theorem in general, but we will only prove a special, but important, case.

Definition 10.6.1. Let $U \subset \mathbb{R}^2$ be a bounded connected open set. Suppose the boundary ∂U is a disjoint union of (the images of) finitely many simple closed piecewise smooth paths such that every $p \in \partial U$ is in the closure of $\mathbb{R}^2 \setminus \bar{U}$. Then U is called a *bounded domain with piecewise smooth boundary* in \mathbb{R}^2 .

The condition about points outside the closure says that locally ∂U separates \mathbb{R}^2 into an “inside” and an “outside.” The condition prevents ∂U from being just a “cut” inside U . As we travel along the path in a certain orientation, there is a well-defined left and a right, and either U is on the left and the complement of U is on the right, or vice versa. The orientation on U is the direction in which we travel along the paths. We can switch orientation if needed by reparametrizing the path.

Definition 10.6.2. Let $U \subset \mathbb{R}^2$ be a bounded domain with piecewise smooth boundary, let ∂U be oriented, and let $\gamma: [a, b] \rightarrow \mathbb{R}^2$ be a parametrization of ∂U giving the orientation. Write $\gamma(t) = (x(t), y(t))$. If the vector $n(t) := (-y'(t), x'(t))$ points into the domain, that is, $\varepsilon n(t) + \gamma(t)$ is in U for all small enough $\varepsilon > 0$, then ∂U is *positively oriented*. See [Figure 10.7](#). Otherwise it is *negatively oriented*.

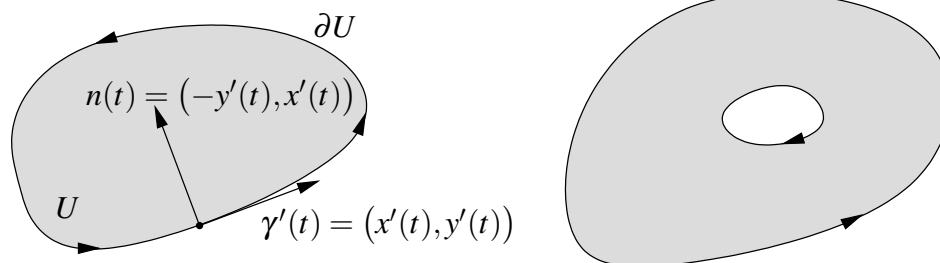

Figure 10.7: Positively oriented domain (left), and a positively oriented domain with a hole (right).

The vector $n(t)$ turns $\gamma'(t)$ counterclockwise by 90° , that is to the left. When we travel along a positively oriented boundary in the direction of its orientation, the domain is “on our left.” For example, if U is a bounded domain with “no holes,” that is ∂U is connected, then the positive orientation means we are traveling counterclockwise around ∂U . If we do have “holes,” then we travel around them clockwise.

Proposition 10.6.3. Let $U \subset \mathbb{R}^2$ be a bounded domain with piecewise smooth boundary. Then U is Jordan measurable.

*Named after the British mathematical physicist [George Green](#) (1793–1841).

Proof. We must show that ∂U is a null set. As ∂U is a finite union of piecewise smooth paths, which are finite unions of smooth paths, we need only show that a smooth path in \mathbb{R}^2 is a null set. Let $\gamma: [a, b] \rightarrow \mathbb{R}^2$ be a smooth path. It is enough to show that $\gamma((a, b))$ is a null set, as adding the points $\gamma(a)$ and $\gamma(b)$, to a null set still results in a null set. Define

$$f: (a, b) \times (-1, 1) \rightarrow \mathbb{R}^2, \quad \text{as} \quad f(x, y) := \gamma(x).$$

The set $(a, b) \times \{0\}$ is a null set in \mathbb{R}^2 and $\gamma((a, b)) = f((a, b) \times \{0\})$. By [Proposition 10.3.10](#), $\gamma((a, b))$ is a null set in \mathbb{R}^2 and so $\gamma([a, b])$ is a null set, and so finally ∂U is a null set. \square

Theorem 10.6.4 (Green). *Suppose $U \subset \mathbb{R}^2$ is a bounded domain with piecewise smooth boundary with the boundary positively oriented. Suppose P and Q are continuously differentiable functions defined on some open set that contains the closure \bar{U} . Then*

$$\int_{\partial U} P \, dx + Q \, dy = \int_U \left(\frac{\partial Q}{\partial x} - \frac{\partial P}{\partial y} \right).$$

We stated Green's theorem in general, although we will only prove a special version of it. That is, we will only prove it for a special kind of domain. The general version follows from the special case by application of further geometry, and cutting up the general domain into smaller domains on which to apply the special case. We will not prove the general case.

Let $U \subset \mathbb{R}^2$ be a domain with piecewise smooth boundary. We say U is of *type I* if there exist numbers $a < b$, and continuous functions $f: [a, b] \rightarrow \mathbb{R}$ and $g: [a, b] \rightarrow \mathbb{R}$, such that

$$U := \{(x, y) \in \mathbb{R}^2 : a < x < b \text{ and } f(x) < y < g(x)\}.$$

Similarly, U is of *type II* if there exist numbers $c < d$, and continuous functions $h: [c, d] \rightarrow \mathbb{R}$ and $k: [c, d] \rightarrow \mathbb{R}$, such that

$$U := \{(x, y) \in \mathbb{R}^2 : c < y < d \text{ and } h(y) < x < k(y)\}.$$

Finally, $U \subset \mathbb{R}^2$ is of *type III* if it is both of type I and type II. See [Figure 10.8](#).

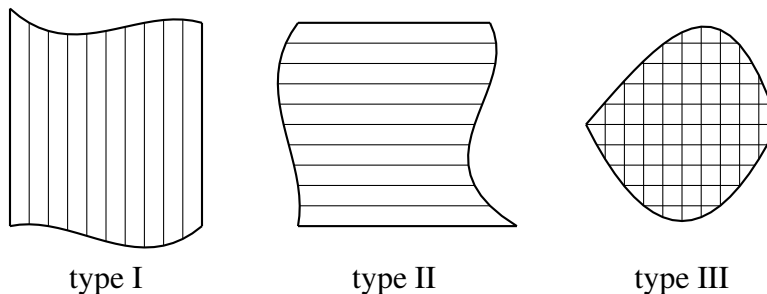

Figure 10.8: Domain types for Green's theorem.

Common domains to apply Green's theorem to are rectangles and discs, and these are type III domains. We will only prove Green's theorem for type III domains.

Proof of Green's theorem for U of type III. Let f, g, h, k be the functions defined above. Using [Exercise 10.5.3](#), U is Jordan measurable and as U is of type I, then

$$\begin{aligned} \int_U \left(-\frac{\partial P}{\partial y} \right) &= \int_a^b \int_{g(x)}^{f(x)} \left(-\frac{\partial P}{\partial y}(x, y) \right) dy dx \\ &= \int_a^b \left(-P(x, f(x)) + P(x, g(x)) \right) dx \\ &= \int_a^b P(x, g(x)) dx - \int_a^b P(x, f(x)) dx. \end{aligned}$$

We integrate $P dx$ along the boundary. The one-form $P dx$ integrates to zero along the straight vertical lines in the boundary. Therefore it is only integrated along the top and along the bottom. As a parameter, x runs from left to right. If we use the parametrizations that take x to $(x, f(x))$ and to $(x, g(x))$ we recognize path integrals above. However the second path integral is in the wrong direction; the top should be going right to left, and so we must switch orientation.

$$\int_{\partial U} P dx = \int_a^b P(x, g(x)) dx + \int_b^a P(x, f(x)) dx = \int_U \left(-\frac{\partial P}{\partial y} \right).$$

Similarly, U is also of type II. The form $Q dy$ integrates to zero along horizontal lines. So

$$\int_U \frac{\partial Q}{\partial x} = \int_c^d \int_{k(y)}^{h(y)} \frac{\partial Q}{\partial x}(x, y) dx dy = \int_a^b \left(Q(y, h(y)) - Q(y, k(y)) \right) dy = \int_{\partial U} Q dy.$$

Putting the two together we obtain

$$\int_{\partial U} P dx + Q dy = \int_{\partial U} P dx + \int_{\partial U} Q dy = \int_U \left(-\frac{\partial P}{\partial y} \right) + \int_U \frac{\partial Q}{\partial x} = \int_U \left(\frac{\partial Q}{\partial x} - \frac{\partial P}{\partial y} \right). \quad \square$$

We illustrate the usefulness of Green's theorem on a fundamental result about harmonic functions.

Example 10.6.5: Suppose $U \subset \mathbb{R}^2$ is open and $f: U \rightarrow \mathbb{R}$ is harmonic, that is, f is twice continuously differentiable and $\frac{\partial^2 f}{\partial x^2} + \frac{\partial^2 f}{\partial y^2} = 0$. We will prove one of the most fundamental properties of harmonic functions.

Let $D_r := B(p, r)$ be closed disc such that its closure $C(p, r) \subset U$. Write $p = (x_0, y_0)$. We orient ∂D_r positively. See [Exercise 10.6.1](#). Then

$$\begin{aligned} 0 &= \frac{1}{2\pi r} \int_{D_r} \left(\frac{\partial^2 f}{\partial x^2} + \frac{\partial^2 f}{\partial y^2} \right) \\ &= \frac{1}{2\pi r} \int_{\partial D_r} -\frac{\partial f}{\partial y} dx + \frac{\partial f}{\partial x} dy \\ &= \frac{1}{2\pi r} \int_0^{2\pi} \left(-\frac{\partial f}{\partial y}(x_0 + r \cos(t), y_0 + r \sin(t)) (-r \sin(t)) \right. \\ &\quad \left. + \frac{\partial f}{\partial x}(x_0 + r \cos(t), y_0 + r \sin(t)) r \cos(t) \right) dt \\ &= \frac{d}{dr} \left[\frac{1}{2\pi} \int_0^{2\pi} f(x_0 + r \cos(t), y_0 + r \sin(t)) dt \right]. \end{aligned}$$

Let $g(r) := \frac{1}{2\pi} \int_0^{2\pi} f(x_0 + r \cos(t), y_0 + r \sin(t)) dt$. Then $g'(r) = 0$ for all $r > 0$. The function is constant for $r > 0$ and continuous at $r = 0$ (exercise). Therefore, $g(0) = g(r)$ for all $r > 0$, and

$$g(r) = g(0) = \frac{1}{2\pi} \int_0^{2\pi} f(x_0 + 0 \cos(t), y_0 + 0 \sin(t)) dt = f(x_0, y_0).$$

We proved the *mean value property* of harmonic functions:

$$f(x_0, y_0) = \frac{1}{2\pi} \int_0^{2\pi} f(x_0 + r \cos(t), y_0 + r \sin(t)) dt = \frac{1}{2\pi r} \int_{\partial D_r} f ds.$$

That is, the value at $p = (x_0, y_0)$ is the average over a circle of any radius r centered at (x_0, y_0) .

10.6.1 Exercises

Exercise 10.6.1: Prove that a disc $B(p, r) \subset \mathbb{R}^2$ is a type III domain, and prove that the orientation given by the parametrization $\gamma(t) = (x_0 + r \cos(t), y_0 + r \sin(t))$ where $p = (x_0, y_0)$ is the positive orientation of the boundary $\partial B(p, r)$.

Note: Feel free to use what you know about sine and cosine from calculus.

Exercise 10.6.2: Prove that a convex bounded domain with piecewise smooth boundary is a type III domain.

Exercise 10.6.3: Suppose $V \subset \mathbb{R}^2$ is a domain with piecewise smooth boundary that is a type III domain and suppose that $U \subset \mathbb{R}^2$ is a domain such that $\bar{V} \subset U$. Suppose $f: U \rightarrow \mathbb{R}$ is a twice continuously differentiable function. Prove that $\int_{\partial V} \frac{\partial f}{\partial x} dx + \frac{\partial f}{\partial y} dy = 0$.

Exercise 10.6.4: For a disc $B(p, r) \subset \mathbb{R}^2$, orient the boundary $\partial B(p, r)$ positively.

- Compute $\int_{\partial B(p, r)} -y dx$.
- Compute $\int_{\partial B(p, r)} x dy$.
- Compute $\int_{\partial B(p, r)} \frac{-y}{2} dx + \frac{x}{2} dy$.

Exercise 10.6.5: Using Green's theorem show that the area of a triangle with vertices (x_1, y_1) , (x_2, y_2) , (x_3, y_3) is $\frac{1}{2}|x_1 y_2 + x_2 y_3 + x_3 y_1 - y_1 x_2 - y_2 x_3 - y_3 x_1|$. *Hint:* See previous exercise.

Exercise 10.6.6: Using the mean value property prove the maximum principle for harmonic functions: Suppose $U \subset \mathbb{R}^2$ is a connected open set and $f: U \rightarrow \mathbb{R}$ is harmonic. Prove that if f attains a maximum at $p \in U$, then f is constant.

Exercise 10.6.7: Let $f(x, y) := \ln \sqrt{x^2 + y^2}$.

- Show f is harmonic where defined.
- Show $\lim_{(x, y) \rightarrow 0} f(x, y) = -\infty$.
- Using a circle C_r of radius r around the origin, compute $\frac{1}{2\pi r} \int_{\partial C_r} f ds$. What happens as $r \rightarrow 0$?
- Why can't you use Green's theorem?

10.7 Change of variables

Note: 1 lecture

In one variable, we have the familiar change of variables

$$\int_a^b f(g(x))g'(x) dx = \int_{g(a)}^{g(b)} f(x) dx.$$

The analogue in higher dimensions is quite a bit more complicated. The first complication is orientation. If we use the definition of integral from this chapter, then we do not have the notion of \int_a^b versus \int_b^a . We are simply integrating over an interval $[a, b]$. With this notation, the change of variables becomes

$$\int_{[a,b]} f(g(x))|g'(x)| dx = \int_{g([a,b])} f(x) dx.$$

In this section we will obtain the several-variable analogue of this form.

Let us remark the role of $|g'(x)|$ in the formula. The integral measures volumes in general, so in one dimension it measures length. Notice that $|g'(x)|$ scales the dx and so it scales the lengths. If our g is linear, that is, $g(x) = Lx$, then $g'(x) = L$ and the length of the interval $g([a, b])$ is simply $|L|(b - a)$. That is because $g([a, b])$ is either $[La, Lb]$ or $[Lb, La]$. This property holds in higher dimension with $|L|$ replaced by the absolute value of the determinant.

Proposition 10.7.1. *Suppose $R \subset \mathbb{R}^n$ is a rectangle and $A: \mathbb{R}^n \rightarrow \mathbb{R}^n$ is linear. Then $A(R)$ is Jordan measurable and $V(A(R)) = |\det(A)|V(R)$.*

Proof. It is enough to prove for elementary matrices. The proof is left as an exercise. \square

Let us prove that absolute value of the Jacobian determinant $|J_g(x)| = |\det(g'(x))|$ is the replacement of $|g'(x)|$ for multiple dimensions in the change of variables formula. The following theorem holds in more generality, but this statement is sufficient for many uses.

Theorem 10.7.2. *Suppose $U \subset \mathbb{R}^n$ is open, $S \subset U$ is a closed bounded Jordan measurable set, and $g: U \rightarrow \mathbb{R}^n$ is a one-to-one continuously differentiable mapping, such that J_g is never zero on S . Suppose $f: g(S) \rightarrow \mathbb{R}$ is Riemann integrable. Then $f \circ g$ is Riemann integrable on S and*

$$\int_{g(S)} f(x) dx = \int_S f(g(x))|J_g(x)| dx.$$

The set $g(S)$ is Jordan measurable by [Proposition 10.5.6](#), so the left-hand side does make sense. That the right-hand side makes sense follows by [Corollary 10.4.4](#) (actually [Exercise 10.5.7](#)).

Proof. The set S can be covered by finitely many closed rectangles P_1, P_2, \dots, P_k , whose interiors do not overlap such that each $P_j \subset U$ ([Exercise 10.7.2](#)). Proving the theorem for $P_j \cap S$ instead of S is enough. Define $f(y) := 0$ for all $y \notin g(S)$. The new f is still Riemann integrable since $g(S)$ is Jordan measurable. We can now replace the integrals over S with integrals over the whole rectangle. We therefore assume that S is equal to a rectangle R .

Let $\varepsilon > 0$ be given. For every $x \in R$, let

$$W_x := \{y \in U : \|g'(x) - g'(y)\| < \varepsilon/2\}.$$

By [Exercise 10.7.3](#), W_x is open. As $x \in W_x$ for every x , it is an open cover. By the Lebesgue covering lemma (Lemma 7.4.10 from volume I), there exists a $\delta > 0$ such that for every $y \in R$, there is an x such that $B(y, \delta) \subset W_x$. In other words, if P is a rectangle of maximum side length less than $\frac{\delta}{\sqrt{n}}$ and $y \in P$, then $P \subset B(y, \delta) \subset W_x$. By triangle inequality, $\|g'(\xi) - g'(\eta)\| < \varepsilon$ for all $\xi, \eta \in P$.

Let R_1, R_2, \dots, R_N be subrectangles partitioning R such that the maximum side of every R_j is less than $\frac{\delta}{\sqrt{n}}$. We also make sure that the minimum side length is at least $\frac{\delta}{2\sqrt{n}}$, which we can do if δ is sufficiently small relative to the sides of R ([Exercise 10.7.4](#)).

Consider some R_j and some fixed $x_j \in R_j$. First suppose $x_j = 0$, $g(0) = 0$, and $g'(0) = I$. For any given $y \in R_j$, apply the fundamental theorem of calculus to the function $t \mapsto g(ty)$ to find $g(y) = \int_0^1 g'(ty)y \, dt$. As the side of R_j is at most $\frac{\delta}{\sqrt{n}}$, then $\|y\| \leq \delta$. So

$$\|g(y) - y\| = \left\| \int_0^1 (g'(ty)y - y) \, dt \right\| \leq \int_0^1 \|g'(ty)y - y\| \, dt \leq \|y\| \int_0^1 \|g'(ty) - I\| \, dt \leq \delta\varepsilon.$$

Therefore, $g(R_j) \subset \tilde{R}_j$, where \tilde{R}_j is a rectangle obtained from R_j by extending by $\delta\varepsilon$ on all sides. See [Figure 10.9](#).

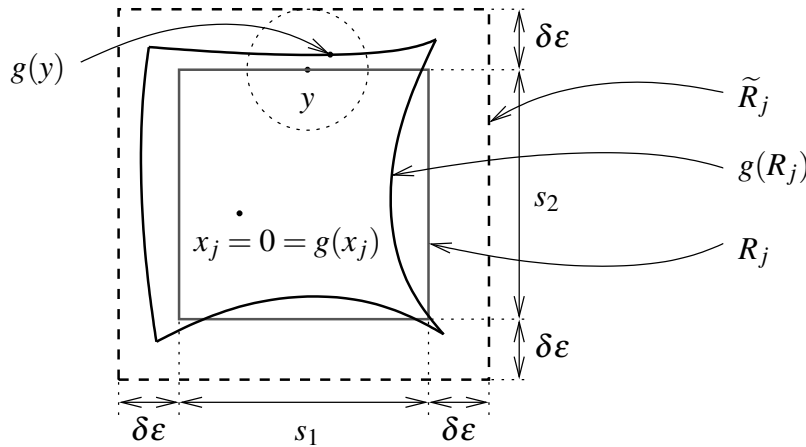

Figure 10.9: Image of R_j under g lies inside \tilde{R}_j . A sample point $y \in R_j$ (on the boundary of R_j in fact) is marked and $g(y)$ must lie within with a radius of $\delta\varepsilon$ (also marked).

If the sides of R_j are s_1, s_2, \dots, s_n , then $V(R_j) = s_1 s_2 \cdots s_n$. Recall $\delta \leq 2\sqrt{n}s_j$. Thus,

$$\begin{aligned} V(\tilde{R}_j) &= (s_1 + 2\delta\varepsilon)(s_2 + 2\delta\varepsilon) \cdots (s_n + 2\delta\varepsilon) \\ &\leq (s_1 + 4\sqrt{n}s_1\varepsilon)(s_2 + 4\sqrt{n}s_2\varepsilon) \cdots (s_n + 4\sqrt{n}s_n\varepsilon) \\ &= s_1(1 + 4\sqrt{n}\varepsilon)s_2(1 + 4\sqrt{n}\varepsilon) \cdots s_n(1 + 4\sqrt{n}\varepsilon) = V(R_j)(1 + 4\sqrt{n}\varepsilon)^n. \end{aligned}$$

In other words,

$$V(g(R_j)) \leq V(\tilde{R}_j) \leq V(R_j)(1 + 4\sqrt{n}\varepsilon)^n.$$

Next, suppose $A := g'(0)$ is not necessarily the identity. Write $g = A \circ \tilde{g}$ where $\tilde{g}'(0) = I$. By Proposition 10.7.1, $V(A(R_j)) = |\det(A)|V(R_j)$, and hence

$$\begin{aligned} V(g(R_j)) &\leq |\det(A)|V(R_j)(1 + 4\sqrt{n}\varepsilon)^n \\ &= |J_g(0)|V(R_j)(1 + 4\sqrt{n}\varepsilon)^n. \end{aligned}$$

Translation does not change volume, and therefore for every R_j , and $x_j \in R_j$, including when $x_j \neq 0$ and $g(x_j) \neq 0$, we find

$$V(g(R_j)) \leq |J_g(x_j)|V(R_j)(1 + 4\sqrt{n}\varepsilon)^n.$$

Write f as $f = f_+ - f_-$ for two nonnegative Riemann integrable functions f_+ and f_- :

$$f_+(x) := \max\{f(x), 0\}, \quad f_-(x) := \max\{-f(x), 0\}.$$

So, if we prove the theorem for a nonnegative f , we obtain the theorem for arbitrary f . Therefore, suppose that $f(y) \geq 0$ for all $y \in R$.

For a small enough $\delta > 0$, we have

$$\begin{aligned} \varepsilon + \int_R f(g(x))|J_g(x)| dx &\geq \sum_{j=1}^N \left(\sup_{x \in R_j} f(g(x))|J_g(x)| \right) V(R_j) \\ &\geq \sum_{j=1}^N \left(\sup_{x \in R_j} f(g(x)) \right) |J_g(x_j)| V(R_j) \\ &\geq \sum_{j=1}^N \left(\sup_{y \in g(R_j)} f(y) \right) V(g(R_j)) \frac{1}{(1 + 4\sqrt{n}\varepsilon)^n} \\ &\geq \sum_{j=1}^N \left(\int_{g(R_j)} f(y) dy \right) \frac{1}{(1 + 4\sqrt{n}\varepsilon)^n} \\ &= \frac{1}{(1 + 4\sqrt{n}\varepsilon)^n} \int_{g(R)} f(y) dy. \end{aligned}$$

The last equality follows because the overlaps of the rectangles are their boundaries, which are of measure zero, and hence the image of their boundaries is also measure zero. Let ε go to zero to find

$$\int_R f(g(x))|J_g(x)| dx \geq \int_{g(R)} f(y) dy.$$

By adding this result for several rectangles covering an S we obtain the result for an arbitrary bounded Jordan measurable $S \subset U$, and nonnegative integrable function f :

$$\int_S f(g(x))|J_g(x)| dx \geq \int_{g(S)} f(y) dy.$$

Recall that g^{-1} exists and $g^{-1}(g(S)) = S$. Also $1 = J_{g \circ g^{-1}} = J_g(g^{-1}(y))J_{g^{-1}}(y)$ for $y \in g(S)$. So

$$\begin{aligned} \int_{g(S)} f(y) dy &= \int_{g(S)} f(g(g^{-1}(y)))|J_g(g^{-1}(y))||J_{g^{-1}}(y)| dy \\ &\geq \int_{g^{-1}(g(S))} f(g(x))|J_g(x)| dx = \int_S f(g(x))|J_g(x)| dx. \end{aligned}$$

The conclusion of the theorem holds for all nonnegative f and as we mentioned above, it thus holds for all Riemann integrable f . \square

10.7.1 Exercises

Exercise 10.7.1: Prove Proposition 10.7.1.

Exercise 10.7.2: Suppose $U \subset \mathbb{R}^n$ is open and $S \subset U$ is a closed bounded Jordan measurable set. Show that there exist finitely many closed bounded rectangles P_1, P_2, \dots, P_k such that $P_j \subset U$, $S \subset P_1 \cup P_2 \cup \dots \cup P_k$, and the interiors are mutually disjoint, that is $P_j^\circ \cap P_\ell^\circ = \emptyset$ whenever $j \neq \ell$.

Exercise 10.7.3: Suppose $U \subset \mathbb{R}^n$ is open, $x \in U$, and $g: U \rightarrow \mathbb{R}^n$ is a continuously differentiable mapping. For every $\varepsilon > 0$, show that

$$W_x := \{y \in U : \|g'(x) - g'(y)\| < \varepsilon/2\}$$

is an open set.

Exercise 10.7.4: Suppose $R \subset \mathbb{R}^n$ is a closed bounded rectangle. Show that if $\delta' > 0$ is sufficiently small relative to the sides of R , then R can be partitioned into subrectangles where each side of every subrectangle is between $\frac{\delta'}{2}$ and δ' .

Exercise 10.7.5: Prove the following version of the theorem: Suppose $f: \mathbb{R}^n \rightarrow \mathbb{R}$ is a Riemann integrable compactly supported function. Suppose $K \subset \mathbb{R}^n$ is the support of f , S is a compact set, and $g: \mathbb{R}^n \rightarrow \mathbb{R}^n$ is a function that when restricted to a neighborhood U of S is one-to-one and continuously differentiable, $g(S) = K$ and J_g is never zero on S (in the formula assume $J_g(x) = 0$ if g not differentiable at x , that is when $x \notin U$). Then

$$\int_{\mathbb{R}^n} f(x) dx = \int_{\mathbb{R}^n} f(g(x)) |J_g(x)| dx.$$

Exercise 10.7.6: Prove the following version of the theorem: Suppose $S \subset \mathbb{R}^n$ is an open bounded Jordan measurable set, $g: S \rightarrow \mathbb{R}^n$ is a one-to-one continuously differentiable mapping such that J_g is never zero on S , and such that $g(S)$ is bounded and Jordan measurable (it is also open). Suppose $f: g(S) \rightarrow \mathbb{R}$ is Riemann integrable. Then $f \circ g$ is Riemann integrable on S and

$$\int_{g(S)} f(x) dx = \int_S f(g(x)) |J_g(x)| dx.$$

Hint: Write S as an increasing union of closed bounded Jordan measurable sets, then apply the theorem of the section to those. Then prove that you can take the limit.

Chapter 11

Functions as Limits

11.1 Complex numbers

Note: half a lecture

11.1.1 The complex plane

In this chapter we consider approximation of functions, or in other words functions as limits of sequences and series. We will extend some results we already saw to a somewhat more general setting, and we will look at some completely new results. In particular, we consider complex-valued functions. We gave complex numbers as examples before, but let us start from scratch and properly define the complex number field.

A complex number is just a pair $(x, y) \in \mathbb{R}^2$ on which we define multiplication (see below). We call the set the *complex numbers* and denote it by \mathbb{C} . We identify $x \in \mathbb{R}$ with $(x, 0) \in \mathbb{C}$. The x -axis is then called the *real axis* and the y -axis is called the *imaginary axis*. The set \mathbb{C} is sometimes called the *complex plane*.

Define:

$$\begin{aligned}(x, y) + (s, t) &:= (x + s, y + t), \\ (x, y)(s, t) &:= (xs - yt, xt + ys).\end{aligned}$$

Under the identification above, we have $0 = (0, 0)$ and $1 = (1, 0)$. These two operations make the plane into a field (exercise).

We write a complex number (x, y) as $x + iy$, where we define*

$$i := (0, 1).$$

Notice that $i^2 = (0, 1)(0, 1) = (0 - 1, 0 + 0) = -1$. That is, i is a solution to the polynomial equation

$$z^2 + 1 = 0.$$

From now on, we will not use the notation (x, y) and use only $x + iy$. See [Figure 11.1](#).

We generally use x, y, r, s, t for real values and z, w, ξ, ζ for complex values, although that is not a hard and fast rule. In particular, z is often used as a third real variable in \mathbb{R}^3 .

*Note that engineers use j instead of i .

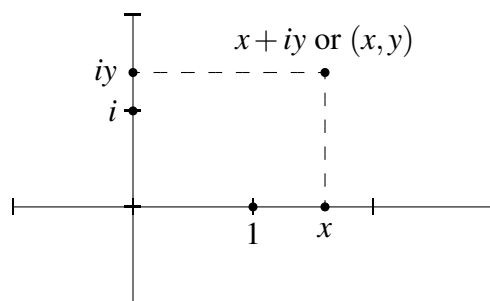

Figure 11.1: The points 1 , i , x , iy , and $x + iy$ in the complex plane.

Definition 11.1.1. Suppose $z = x + iy$. We call x the *real part* of z , and we call y the *imaginary part* of z . We write

$$\operatorname{Re} z := x, \quad \operatorname{Im} z := y.$$

Define *complex conjugate* as

$$\bar{z} := x - iy,$$

and define *modulus* as

$$|z| := \sqrt{x^2 + y^2}.$$

Modulus is the complex analogue of the absolute value and has similar properties. For example, $|zw| = |z||w|$ (exercise). The complex conjugate is a reflection of the plane across the real axis. The real numbers are precisely those numbers for which the imaginary part $y = 0$. In particular, they are precisely those numbers which satisfy the equation

$$z = \bar{z}.$$

As \mathbb{C} is really \mathbb{R}^2 , we let the metric on \mathbb{C} be the standard euclidean metric on \mathbb{R}^2 . In particular,

$$|z| = d(z, 0), \quad \text{and also} \quad |z - w| = d(z, w).$$

So the topology on \mathbb{C} is the same exact topology as the standard topology on \mathbb{R}^2 with the euclidean metric, and $|z|$ is equal to the euclidean norm on \mathbb{R}^2 . Importantly, since \mathbb{R}^2 is a complete metric space, then so is \mathbb{C} .

Since $|z|$ is the euclidean norm on \mathbb{R}^2 , we have the *triangle inequality* of both flavors:

$$|z + w| \leq |z| + |w| \quad \text{and} \quad \left| |z| - |w| \right| \leq |z - w|.$$

The complex conjugate and the modulus are even more intimately related:

$$|z|^2 = x^2 + y^2 = (x + iy)(x - iy) = z\bar{z}.$$

Remark 11.1.2. There is no natural ordering on the complex numbers. In particular, no ordering that makes the complex numbers into an ordered field. Ordering is one of the things we lose when we go from real to complex numbers.

11.1.2 Complex numbers and limits

It is not hard to show that the algebraic operations are continuous. This is because convergence in \mathbb{R}^2 is the same as convergence for each component and we already know that the real algebraic operations are continuous. For example, write $z_n = x_n + iy_n$ and $w_n = s_n + it_n$, and suppose that $\lim z_n = z = x + iy$ and $\lim w_n = w = s + it$. Let us show

$$\lim_{n \rightarrow \infty} z_n w_n = zw.$$

First,

$$z_n w_n = (x_n s_n - y_n t_n) + i(x_n t_n + y_n s_n).$$

The topology on \mathbb{C} is the same as on \mathbb{R}^2 , and so $x_n \rightarrow x$, $y_n \rightarrow y$, $s_n \rightarrow s$, and $t_n \rightarrow t$. Hence,

$$\lim_{n \rightarrow \infty} (x_n s_n - y_n t_n) = xs - yt \quad \text{and} \quad \lim_{n \rightarrow \infty} (x_n t_n + y_n s_n) = xt + ys.$$

As $(xs - yt) + i(xt + ys) = zw$, then

$$\lim_{n \rightarrow \infty} z_n w_n = zw.$$

Similarly the modulus and the complex conjugate are continuous functions. We leave the proof of the following proposition as an exercise.

Proposition 11.1.3. *Suppose $\{z_n\}$, $\{w_n\}$ are sequences of complex numbers converging to z and w respectively. Then*

- (i) $\lim_{n \rightarrow \infty} z_n + w_n = z + w$.
- (ii) $\lim_{n \rightarrow \infty} z_n w_n = zw$.
- (iii) Assuming $w_n \neq 0$ for all n and $w \neq 0$, $\lim_{n \rightarrow \infty} \frac{z_n}{w_n} = \frac{z}{w}$.
- (iv) $\lim_{n \rightarrow \infty} |z_n| = |z|$.
- (v) $\lim_{n \rightarrow \infty} \bar{z}_n = \bar{z}$.

As we have seen above, convergence in \mathbb{C} is the same as convergence in \mathbb{R}^2 . In particular, a sequence in \mathbb{C} converges if and only if the real and imaginary parts converge. Therefore, feel free to apply everything you have learned about convergence in \mathbb{R}^2 , as well as applying results about real numbers to the real and imaginary parts.

We also need convergence of complex series. Let $\{z_n\}$ be a sequence of complex numbers. The series

$$\sum_{n=1}^{\infty} z_n$$

converges if the limit of partial sums converges, that is, if

$$\lim_{k \rightarrow \infty} \sum_{n=1}^k z_n \quad \text{exists.}$$

As before, we sometimes write $\sum z_n$ for the series. A series *converges absolutely* if $\sum |z_n|$ converges.

We say a series is *Cauchy* if the sequence of partial sums is Cauchy. The following two propositions have essentially the same proofs as for real series and we leave them as exercises.

Proposition 11.1.4. *The complex series $\sum z_n$ is Cauchy if for every $\varepsilon > 0$, there exists an $M \in \mathbb{N}$ such that for every $n \geq M$ and every $k > n$, we have*

$$\left| \sum_{j=n+1}^k z_j \right| < \varepsilon.$$

Proposition 11.1.5. *If a complex series $\sum z_n$ converges absolutely, then it converges.*

The series $\sum |z_n|$ is a real series. All the convergence tests (ratio test, root test, etc.) that talk about absolute convergence work with the numbers $|z_n|$, that is, they are really talking about convergence of series of nonnegative real numbers. You can directly apply these tests them without needing to reprove anything for complex series.

11.1.3 Complex-valued functions

When we deal with complex-valued functions $f: X \rightarrow \mathbb{C}$, what we often do is to write $f = u + iv$ for real-valued functions $u: X \rightarrow \mathbb{R}$ and $v: X \rightarrow \mathbb{R}$.

Suppose we wish to integrate $f: [a, b] \rightarrow \mathbb{C}$. We write $f = u + iv$ for real-valued u and v . We say that f is *Riemann integrable* if u and v are Riemann integrable, and in this case we define

$$\int_a^b f := \int_a^b u + i \int_a^b v.$$

We make the same definition for every other type of integral (improper, multivariable, etc.).

Similarly when we differentiate, write $f: [a, b] \rightarrow \mathbb{C}$ as $f = u + iv$. Thinking of \mathbb{C} as \mathbb{R}^2 we say that f is differentiable if u and v are differentiable. For a function valued in \mathbb{R}^2 , the derivative was represented by a vector in \mathbb{R}^2 . Now a vector in \mathbb{R}^2 is a complex number. In other words, we write the *derivative* as

$$f'(t) := u'(t) + iv'(t).$$

The linear operator representing the derivative is the multiplication by the complex number $f'(t)$, so nothing is lost in this identification.

11.1.4 Exercises

Exercise 11.1.1: *Check that \mathbb{C} is a field.*

Exercise 11.1.2: *Prove that for $z, w \in \mathbb{C}$, we have $|zw| = |z||w|$.*

Exercise 11.1.3: *Finish the proof of Proposition 11.1.3.*

Exercise 11.1.4: *Prove Proposition 11.1.4.*

Exercise 11.1.5: *Prove Proposition 11.1.5.*

Exercise 11.1.6: Considering the definition of complex multiplication, given $x + iy$ define the matrix $\begin{bmatrix} x & -y \\ y & x \end{bmatrix}$. Prove that

- The action of this matrix on a vector (s, t) is the same as the action of multiplying $(x + iy)(s + it)$.
- Multiplying two such matrices is the same multiplying the underlying complex numbers and then finding the corresponding matrix for the product. In other words, we can think of the field \mathbb{C} as also a subset of the 2-by-2 matrices.
- Show that $\begin{bmatrix} x & -y \\ y & x \end{bmatrix}$ has eigenvalues $x + iy$ and $x - iy$. Recall that λ is an eigenvalue of a matrix A if $A - \lambda I$ (a complex matrix in our case) is not invertible, or in other words if it has linearly dependent rows: That is, one row is a (complex) multiple of the other

Exercise 11.1.7: Prove the Bolzano–Weierstrass theorem for complex sequences. Suppose $\{z_n\}$ is a bounded sequence of complex numbers, that is, there exists an M such that $|z_n| \leq M$ for all n . Prove that there exists a subsequence $\{z_{n_k}\}$ that converges to some $z \in \mathbb{C}$.

Exercise 11.1.8:

- Prove that there is no simple mean value theorem for complex-valued functions: Find a differentiable function $f: [0, 1] \rightarrow \mathbb{C}$ such that $f(0) = f(1) = 0$, but $f'(t) \neq 0$ for all $t \in [0, 1]$.
- However, there is a weaker form of the mean value theorem as there is for vector-valued functions. Prove: If $f: [a, b] \rightarrow \mathbb{C}$ is continuous and differentiable in (a, b) , and for some M , $|f'(x)| \leq M$ for all $x \in (a, b)$, then $|f(b) - f(a)| \leq M|b - a|$.

Exercise 11.1.9: Prove that there is no simple mean value theorem for integrals for complex-valued functions: Find a continuous function $f: [0, 1] \rightarrow \mathbb{C}$ such that $\int_0^1 f = 0$ but $f(t) \neq 0$ for all $t \in [0, 1]$.

11.2 Swapping limits

Note: 2 lectures

11.2.1 Continuity

Let us get back to swapping limits. Let $\{f_n\}$ be a sequence of functions $f_n: X \rightarrow Y$ for a set X and a metric space Y . Let $f: X \rightarrow Y$ be a function and for every $x \in X$ suppose that

$$f(x) = \lim_{n \rightarrow \infty} f_n(x).$$

We say the sequence $\{f_n\}$ *converges pointwise* to f .

Suppose $Y = \mathbb{C}$, a series *converges pointwise* if for every $x \in X$, we have

$$f(x) = \lim_{n \rightarrow \infty} \sum_{k=1}^n f_k(x) = \sum_{k=1}^{\infty} f_k(x).$$

The question is: If f_n are all continuous, is f continuous? Differentiable? Integrable? What are the derivatives or integrals of f ?

For example, for continuity of the pointwise limit of a sequence $\{f_n\}$, we are asking if

$$\lim_{x \rightarrow x_0} \lim_{n \rightarrow \infty} f_n(x) \stackrel{?}{=} \lim_{n \rightarrow \infty} \lim_{x \rightarrow x_0} f_n(x).$$

We don't even a priori know if both sides exist, let alone if they are equal each other.

Example 11.2.1: The functions $f_n: \mathbb{R} \rightarrow \mathbb{R}$,

$$f_n(x) := \frac{1}{1 + nx^2}$$

are continuous and converge pointwise to

$$f(x) := \begin{cases} 1 & \text{if } x = 0, \\ 0 & \text{else,} \end{cases}$$

which is not continuous.

So pointwise convergence is not enough to preserve continuity (nor even boundedness). For that, we need uniform convergence.

Let $f_n: X \rightarrow Y$ be functions. Then $\{f_n\}$ *converges uniformly* to f if for every $\varepsilon > 0$, there exists an M such that for all $n \geq M$ and all $x \in X$, we have

$$d(f_n(x), f(x)) < \varepsilon.$$

A series $\sum f_n$ of complex-valued functions converges uniformly if the sequence of partial sums converges uniformly, that is for every $\varepsilon > 0$ there exists an M such that for all $n \geq M$ and all $x \in X$

$$\left| \left(\sum_{k=1}^n f_k(x) \right) - f(x) \right| < \varepsilon.$$

The simplest property preserved by uniform convergence is boundedness. We leave the proof of the following proposition as an exercise. It is almost identical to the proof for real-valued functions.

Proposition 11.2.2. *Let X be a set and Y a metric space. If $f_n: X \rightarrow Y$ are bounded functions and converge uniformly to $f: X \rightarrow Y$, then f is bounded.*

We have a notion of *uniformly Cauchy* as for real-valued functions. The proof of the following proposition is again essentially the same as for the real-valued functions and is left as an exercise.

Proposition 11.2.3. *Let X be a set and let (Y, d) be a Cauchy complete metric space. Let $f_n: X \rightarrow Y$ be functions. Then $\{f_n\}$ converges uniformly if and only if for every $\varepsilon > 0$, there is an M such that for all $n, m \geq M$ and all $x \in X$, we have*

$$d(f_n(x), f_m(x)) < \varepsilon.$$

For $f: X \rightarrow \mathbb{C}$, we write

$$\|f\|_u := \sup_{x \in X} |f(x)|.$$

We call $\|\cdot\|_u$ the *supremum norm* or *uniform norm*. Then a sequence of functions $f_n: X \rightarrow \mathbb{C}$ converges uniformly to $f: X \rightarrow \mathbb{C}$ if and only if

$$\lim_{n \rightarrow \infty} \|f_n - f\|_u = 0.$$

The supremum norm satisfies the triangle inequality: For every $x \in X$,

$$|f(x) + g(x)| \leq |f(x)| + |g(x)| \leq \|f\|_u + \|g\|_u.$$

Take a supremum on the left to get

$$\|f + g\|_u \leq \|f\|_u + \|g\|_u.$$

For a compact metric space X , the uniform norm is a norm on the vector space $C(X, \mathbb{C})$. We leave it as an exercise. While we will not need it, $C(X, \mathbb{C})$ is in fact a complex vector space, that is, in the definition of a vector space we can replace \mathbb{R} with \mathbb{C} . Convergence in the metric space $C(X, \mathbb{C})$ is uniform convergence.

We will study a couple of types of series of functions, and a useful test for uniform convergence of a series is the so-called *Weierstrass M -test*.

Theorem 11.2.4 (Weierstrass M -test). *Let X be a set. Suppose $f_n: X \rightarrow \mathbb{C}$ are functions and $M_n > 0$ numbers such that*

$$|f_n(x)| \leq M_n \quad \text{for all } x \in X, \quad \text{and} \quad \sum_{n=1}^{\infty} M_n \quad \text{converges.}$$

Then

$$\sum_{n=1}^{\infty} f_n(x) \quad \text{converges uniformly.}$$

Another way to state the theorem is to say that if $\sum \|f_n\|_u$ converges, then $\sum f_n$ converges uniformly. Note that the converse of this theorem is not true.

Proof. Suppose $\sum M_n$ converges. Given $\varepsilon > 0$, we have that the partial sums of $\sum M_n$ are Cauchy so for there is an N such that for all $m, n \geq N$ with $m \geq n$, we have

$$\sum_{k=n+1}^m M_k < \varepsilon.$$

We estimate a Cauchy difference of the partial sums of the functions

$$\left| \sum_{k=n+1}^m f_k(x) \right| \leq \sum_{k=n+1}^m |f_k(x)| \leq \sum_{k=n+1}^m M_k < \varepsilon.$$

We are done by [Proposition 11.1.4](#). □

Example 11.2.5: The series

$$\sum_{n=1}^{\infty} \frac{\sin(nx)}{n^2}$$

converges uniformly on \mathbb{R} . See [Figure 11.2](#). This is a Fourier series, we will see more of these in a later section. It converges uniformly because

$$\left| \frac{\sin(nx)}{n^2} \right| \leq \frac{1}{n^2},$$

and $\sum_{n=1}^{\infty} \frac{1}{n^2}$ converges.

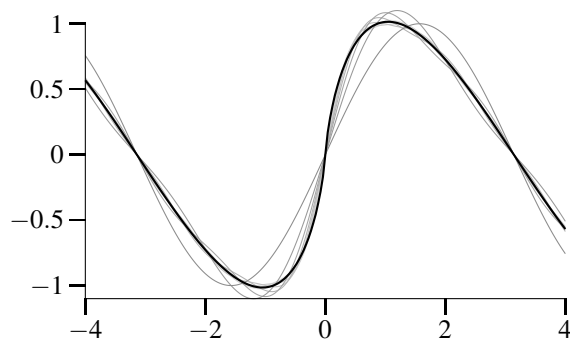

Figure 11.2: Plot of $\sum_{n=1}^{\infty} \frac{\sin(nx)}{n^2}$ including the first 8 partial sums in various shades of gray.

Example 11.2.6: The series

$$\sum_{n=0}^{\infty} \frac{x^n}{n!}$$

converges uniformly on every bounded interval. *Proof:* Take the interval $[-r, r] \subset \mathbb{R}$ (every bounded interval is contained in such an interval). Then

$$\left| \frac{x^n}{n!} \right| \leq \frac{r^n}{n!}$$

and $\sum_{n=1}^{\infty} \frac{r^n}{n!}$ converges by the ratio test.

Now we would love to say something about the limit. For example, is it continuous?

Proposition 11.2.7. *Let (X, d_X) and (Y, d_Y) be metric spaces, and let $f_n: X \rightarrow Y$ be functions. Suppose Y is complete metric space. Suppose $\{f_n\}$ converges uniformly to $f: X \rightarrow Y$. Let $\{x_k\}$ be a sequence in X and $x := \lim x_k$. Suppose that*

$$a_n := \lim_{k \rightarrow \infty} f_n(x_k)$$

exists for all n . Then $\{a_n\}$ converges and

$$\lim_{k \rightarrow \infty} f(x_k) = \lim_{n \rightarrow \infty} a_n.$$

In other words,

$$\lim_{k \rightarrow \infty} \lim_{n \rightarrow \infty} f_n(x_k) = \lim_{n \rightarrow \infty} \lim_{k \rightarrow \infty} f_n(x_k).$$

Proof. First we show that $\{a_n\}$ converges. As $\{f_n\}$ converges uniformly it is uniformly Cauchy. Let $\varepsilon > 0$ be given. There is an M such that for all $m, n \geq M$, we have

$$d_Y(f_n(x_k), f_m(x_k)) < \varepsilon \quad \text{for all } k.$$

As a metric is automatically continuous we let k go to infinity to find

$$d_Y(a_n, a_m) \leq \varepsilon.$$

Hence $\{a_n\}$ is Cauchy and converges since Y is complete. Write $a := \lim a_n$.

Find a $k \in \mathbb{N}$ such that

$$d_Y(f_k(p), f(p)) < \varepsilon/3$$

for all $p \in X$. Assume k is large enough so that

$$d_Y(a_k, a) < \varepsilon/3.$$

Find an $N \in \mathbb{N}$ such that for $m \geq N$,

$$d_Y(f_k(x_m), a_k) < \varepsilon/3.$$

Then for $m \geq N$,

$$d_Y(f(x_m), a) \leq d_Y(f(x_m), f_k(x_m)) + d_Y(f_k(x_m), a_k) + d_Y(a_k, a) < \varepsilon/3 + \varepsilon/3 + \varepsilon/3 = \varepsilon. \quad \square$$

We obtain an immediate corollary about continuity.

Corollary 11.2.8. *Let X and Y be metric spaces such that Y is Cauchy complete. Let $f_n: X \rightarrow Y$ be continuous functions such that $\{f_n\}$ converges uniformly to $f: X \rightarrow Y$. Then f is continuous.*

The converse is not true. Just because the limit is continuous doesn't mean that the convergence is uniform. For example: $f_n: (0, 1) \rightarrow \mathbb{R}$ defined by $f_n(x) := x^n$ converge to the zero function, but not uniformly. However, if we add extra conditions on the sequence, we can obtain a partial converse such as Dini's theorem, see Exercise 6.2.10 from volume I.

In [Exercise 11.2.3](#) the reader is asked to prove that for a compact X , $C(X, \mathbb{C})$ is a normed vector space with the uniform norm, and hence a metric space. We have just shown that $C(X, \mathbb{C})$ is Cauchy complete: [Proposition 11.2.3](#) says that a Cauchy sequence in $C(X, \mathbb{C})$ converges to some function, and [Corollary 11.2.8](#) shows that the limit is continuous and hence in $C(X, \mathbb{C})$.

Corollary 11.2.9. *Let (X, d) be a compact metric space. Then $C(X, \mathbb{C})$ is a Cauchy complete metric space.*

Example 11.2.10: By [Example 11.2.5](#) the Fourier series

$$\sum_{n=1}^{\infty} \frac{\sin(nx)}{n^2}$$

converges uniformly and hence is continuous by [Corollary 11.2.8](#) (as is visible in [Figure 11.2](#)).

11.2.2 Integration

Proposition 11.2.11. *Suppose $f_n: [a, b] \rightarrow \mathbb{C}$ are Riemann integrable and suppose that $\{f_n\}$ converges uniformly to $f: [a, b] \rightarrow \mathbb{C}$. Then f is Riemann integrable and*

$$\int_a^b f = \lim_{n \rightarrow \infty} \int_a^b f_n.$$

Since the integral of a complex-valued function is just the integral of the real and imaginary parts separately, the proof follows directly by the results of chapter 6 of volume I. We leave the details as an exercise.

Corollary 11.2.12. *Suppose $f_n: [a, b] \rightarrow \mathbb{C}$ are Riemann integrable and suppose that*

$$\sum_{n=1}^{\infty} f_n(x)$$

converges uniformly. Then the series is Riemann integrable on $[a, b]$ and

$$\int_a^b \sum_{n=1}^{\infty} f_n(x) dx = \sum_{n=1}^{\infty} \int_a^b f_n(x) dx$$

Example 11.2.13: Let us show how to integrate a Fourier series.

$$\int_0^x \sum_{n=1}^{\infty} \frac{\cos(nt)}{n^2} dt = \sum_{n=1}^{\infty} \int_0^x \frac{\cos(nt)}{n^2} dt = \sum_{n=1}^{\infty} \frac{\sin(nx)}{n^3}$$

The swapping of integral and sum is possible because of uniform convergence, which we have proved before using the Weierstrass M -test ([Theorem 11.2.4](#)).

We remark that we can swap integrals and limits under far less stringent hypotheses, but for that we would need a stronger integral than the Riemann integral. E.g. the Lebesgue integral.

11.2.3 Differentiation

Recall that a complex-valued function $f: [a, b] \rightarrow \mathbb{C}$, where $f(x) = u(x) + iv(x)$, is differentiable, if u and v are differentiable and the derivative is

$$f'(x) = u'(x) + iv'(x).$$

The proof of the following theorem is to apply the corresponding theorem for real functions to u and v , and is left as an exercise.

Theorem 11.2.14. *Let $I \subset \mathbb{R}$ be a bounded interval and let $f_n: I \rightarrow \mathbb{C}$ be continuously differentiable functions. Suppose $\{f_n'\}$ converges uniformly to $g: I \rightarrow \mathbb{C}$, and suppose $\{f_n(c)\}_{n=1}^\infty$ is a convergent sequence for some $c \in I$. Then $\{f_n\}$ converges uniformly to a continuously differentiable function $f: I \rightarrow \mathbb{C}$, and $f' = g$.*

Uniform limits of the functions themselves are not enough, and can make matters even worse. In §11.7 we will prove that continuous functions are uniform limits of polynomials, yet as the following example demonstrates, a continuous function need not be differentiable anywhere.

Example 11.2.15: There exist continuous nowhere differentiable functions. Such functions are often called *Weierstrass functions*, although this particular one, essentially due to Takagi*, is a different example than what Weierstrass gave.

Define

$$\varphi(x) := |x| \quad \text{for } x \in [-1, 1].$$

Extend the definition of φ to all of \mathbb{R} by making it 2-periodic: Decree that $\varphi(x) = \varphi(x+2)$. The function $\varphi: \mathbb{R} \rightarrow \mathbb{R}$ is continuous, in fact $|\varphi(x) - \varphi(y)| \leq |x - y|$ (why?). See Figure 11.3.

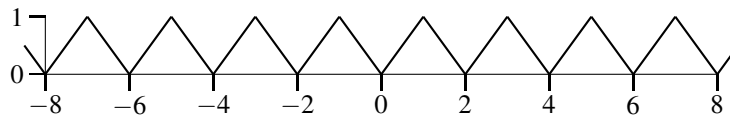

Figure 11.3: The 2-periodic function φ .

As $\sum \left(\frac{3}{4}\right)^n$ converges and $|\varphi(x)| \leq 1$ for all x , we have by the M -test (Theorem 11.2.4) that

$$f(x) := \sum_{n=0}^{\infty} \left(\frac{3}{4}\right)^n \varphi(4^n x)$$

converges uniformly and hence is continuous. See Figure 11.4.

We claim $f: \mathbb{R} \rightarrow \mathbb{R}$ is nowhere differentiable. Fix x , and we will show f is not differentiable at x . Define

$$\delta_m := \pm \frac{1}{2} 4^{-m},$$

where the sign is chosen so that there is no integer between $4^m x$ and $4^m(x + \delta_m) = 4^m x \pm \frac{1}{2}$.

*Teiji Takagi (1875–1960) was a Japanese mathematician.

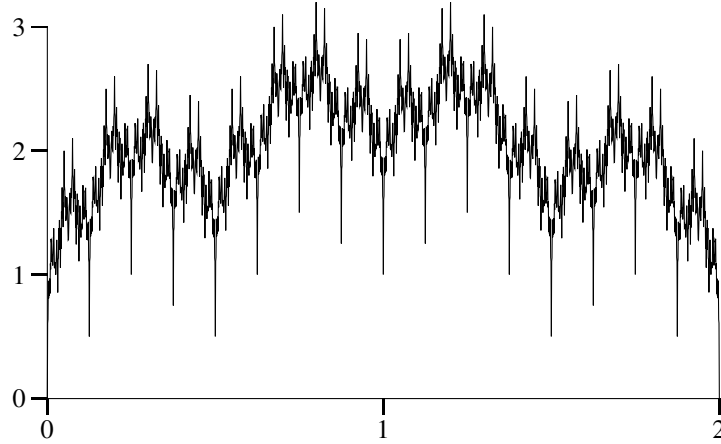

Figure 11.4: Plot of the nowhere differentiable function f .

Fix m for a moment. Let

$$\gamma_n := \frac{\varphi(4^n(x + \delta_m)) - \varphi(4^n x)}{\delta_m}.$$

If $n > m$, then $4^n \delta_m$ is an even integer. As φ is 2-periodic we get that $\gamma_n = 0$.

As there is no integer between $4^m(x + \delta_m) = 4^m x \pm 1/2$ and $4^m x$, then on this interval $\varphi(t) = \pm t + \ell$ for some integer ℓ . In particular, $|\varphi(4^m(x + \delta_m)) - \varphi(4^m x)| = |4^m x \pm 1/2 - 4^m x| = 1/2$. Therefore,

$$|\gamma_m| = \left| \frac{\varphi(4^m(x + \delta_m)) - \varphi(4^m x)}{\pm(1/2)4^{-m}} \right| = 4^m.$$

Similarly, suppose $n < m$. Since $|\varphi(s) - \varphi(t)| \leq |s - t|$,

$$|\gamma_n| = \left| \frac{\varphi(4^n x \pm (1/2)4^{n-m}) - \varphi(4^n x)}{\pm(1/2)4^{-m}} \right| \leq \left| \frac{\pm(1/2)4^{n-m}}{\pm(1/2)4^{-m}} \right| = 4^n.$$

And so

$$\begin{aligned} \left| \frac{f(x + \delta_m) - f(x)}{\delta_m} \right| &= \left| \sum_{n=0}^{\infty} \left(\frac{3}{4} \right)^n \frac{\varphi(4^n(x + \delta_m)) - \varphi(4^n x)}{\delta_m} \right| = \left| \sum_{n=0}^{\infty} \left(\frac{3}{4} \right)^n \gamma_n \right| \\ &= \left| \sum_{n=0}^m \left(\frac{3}{4} \right)^n \gamma_n \right| \\ &\geq \left| \left(\frac{3}{4} \right)^m \gamma_m \right| - \left| \sum_{n=0}^{m-1} \left(\frac{3}{4} \right)^n \gamma_n \right| \\ &\geq 3^m - \sum_{n=0}^{m-1} 3^n = 3^m - \frac{3^m - 1}{3 - 1} = \frac{3^m + 1}{2}. \end{aligned}$$

As $m \rightarrow \infty$, we have $\delta_m \rightarrow 0$, but $\frac{3^m + 1}{2}$ goes to infinity. Hence f cannot be differentiable at x .

11.2.4 Exercises

Exercise 11.2.1: Prove [Proposition 11.2.2](#).

Exercise 11.2.2: Prove [Proposition 11.2.3](#).

Exercise 11.2.3: Suppose (X, d) is a compact metric space. Prove that $\|\cdot\|_u$ is a norm on the vector space of continuous complex-valued functions $C(X, \mathbb{C})$.

Exercise 11.2.4:

- a) Prove that $f_n(x) := 2^{-n} \sin(2^n x)$ converge uniformly to zero, but there exists a dense set $D \subset \mathbb{R}$ such that $\lim_{n \rightarrow \infty} f'_n(x) = 1$ for all $x \in D$.
- b) Prove that $\sum_{n=1}^{\infty} 2^{-n} \sin(2^n x)$ converges uniformly to a continuous function, and there exists a dense set $D \subset \mathbb{R}$ where the derivatives of the partial sums do not converge.

Exercise 11.2.5: Suppose (X, d) is a compact metric space. Prove that $\|f\|_{C^1} := \|f\|_u + \|f'\|_u$ is a norm on the vector space of continuously differentiable complex-valued functions $C^1(X, \mathbb{C})$.

Exercise 11.2.6: Prove [Theorem 11.2.14](#).

Exercise 11.2.7: Prove [Proposition 11.2.11](#) by reducing to the real result.

Exercise 11.2.8: Work through the following counterexample to the converse of the Weierstrass M-test ([Theorem 11.2.4](#)). Define $f_n: [0, 1] \rightarrow \mathbb{R}$ by

$$f_n(x) := \begin{cases} \frac{1}{n} & \text{if } \frac{1}{n+1} < x < \frac{1}{n}, \\ 0 & \text{else.} \end{cases}$$

Prove that $\sum f_n$ converges uniformly, but $\sum \|f_n\|_u$ does not.

Exercise 11.2.9: Suppose $f_n: [0, 1] \rightarrow \mathbb{R}$ are monotone increasing functions and suppose that $\sum f_n$ converges pointwise. Prove that $\sum f_n$ converges uniformly.

Exercise 11.2.10: Prove that

$$\sum_{n=1}^{\infty} e^{-nx}$$

converges for all $x > 0$ to a differentiable function.

11.3 Power series and analytic functions

Note: 2–3 lectures

11.3.1 Analytic functions

A (complex) power series is a series of the form

$$\sum_{n=0}^{\infty} c_n(z-a)^n$$

for $c_n, z, a \in \mathbb{C}$. We say the series *converges* if the series converges for some $z \neq a$.

Let $U \subset \mathbb{C}$ be an open set and $f: U \rightarrow \mathbb{C}$ a function. Suppose that for every $a \in U$ there exists a $\rho > 0$ and a power series convergent to the function

$$f(z) = \sum_{n=0}^{\infty} c_n(z-a)^n$$

for all $z \in B(a, \rho)$. Then we say f is an *analytic* function.

Similarly if we have an interval $(a, b) \subset \mathbb{R}$, we say that $f: (a, b) \rightarrow \mathbb{C}$ is analytic or perhaps *real-analytic* if for each point $c \in (a, b)$ there is a power series around c that converges in some $(c - \rho, c + \rho)$ for some $\rho > 0$.

As we will sometimes talk about real and sometimes about complex power series we will use z to denote a complex number and x a real number, but we will always mention which case we are working with.

An analytic function has different expansions around different points. Also the convergence does not automatically happen on the entire domain of the function. For example, if $|z| < 1$, then

$$\frac{1}{1-z} = \sum_{n=0}^{\infty} z^n.$$

While the left-hand side exists on all of $z \neq 1$, the right-hand side happens to converge only if $|z| < 1$. See a graph of a small piece of $\frac{1}{1-z}$ in [Figure 11.5](#). Notice that we can't graph the function itself, we can only graph its real or imaginary parts for lack of dimensions in our universe.

11.3.2 Convergence of power series

We proved several results for power series of a real variable in §2.6 of volume I. For the most part the convergence properties of power series deal with the series $\sum |c_k| |z-a|^k$ and so we have already proved many results about complex power series. In particular, we computed the so-called *radius of convergence* of a power series.

Proposition 11.3.1. *Let $\sum_{n=0}^{\infty} c_n(z-a)^n$ be a power series. There exists a $\rho \in [0, \infty]$ such that*

(i) *If $\rho = 0$, then the series diverges.*

(ii) *If $\rho = \infty$, then the series converges for all $z \in \mathbb{C}$.*

(iii) *If $0 < \rho < \infty$, then the series converges absolutely on $B(a, \rho)$, and diverges when $|z-a| > \rho$.*

Furthermore, if $0 < r < \rho$, then the series converges uniformly on the closed ball $C(a, r)$.

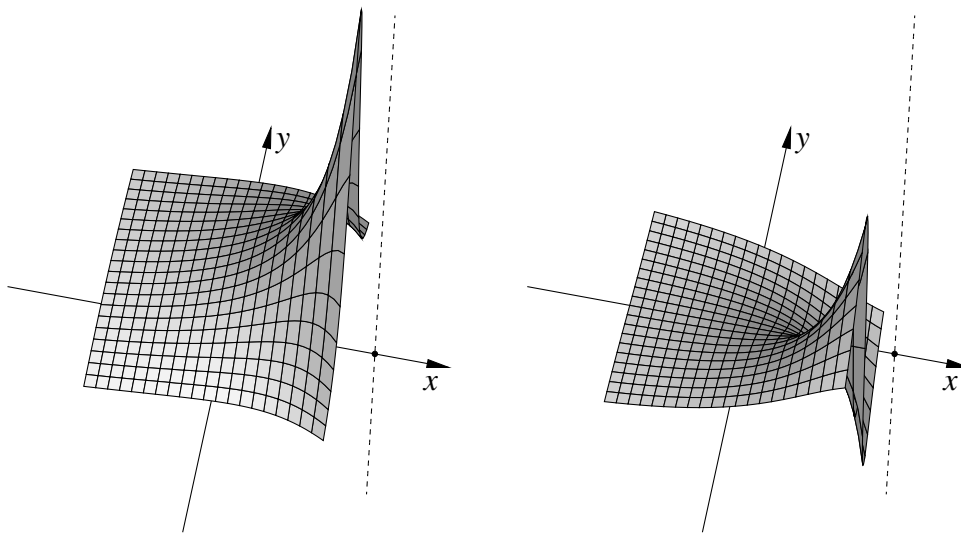

Figure 11.5: Graphs of the real and imaginary parts of $z = x + iy \mapsto \frac{1}{1-z}$ in the square $[-0.8, 0.8]^2$. The singularity at $z = 1$ is marked with a vertical dashed line.

Proof. We use the real version of this proposition, Proposition 2.6.10 in volume I. Let

$$R := \limsup_{n \rightarrow \infty} \sqrt[n]{|c_n|}.$$

If $R = 0$, then $\sum_{n=0}^{\infty} |c_n| |z - a|^n$ converges for all z . If $R = \infty$, then $\sum_{n=0}^{\infty} |c_n| |z - a|^n$ converges only at $z = a$. Otherwise, let $\rho := 1/R$ and $\sum_{n=0}^{\infty} |c_n| |z - a|^n$ converges when $|z - a| < \rho$, and diverges (in fact the terms of the series do not go to zero) when $|z - a| > \rho$.

To prove the furthermore suppose $0 < r < \rho$ and $z \in C(a, r)$. Then consider the partial sums

$$\left| \sum_{n=0}^k c_n (z - a)^n \right| \leq \sum_{n=0}^k |c_n| |z - a|^n \leq \sum_{n=0}^k |c_n| r^n. \quad \square$$

The number ρ is called the *radius of convergence*. See Figure 11.6. The radius of convergence gives us a disk around a where the series converges. A power series is convergent if $\rho > 0$.

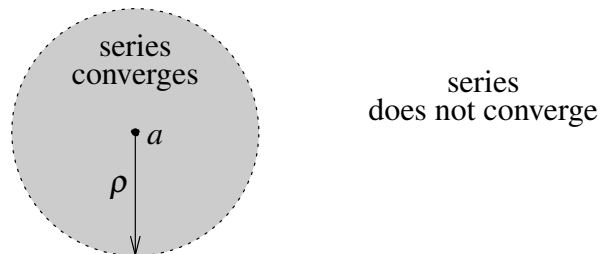

Figure 11.6: Radius of convergence.

If $\sum c_n(z-a)^n$ converges for some z , then

$$\sum c_n(w-a)^n$$

converges absolutely whenever $|w-a| < |z-a|$. Conversely if the series diverges at z , then it must diverge at w whenever $|w-a| > |z-a|$. This means that to show that the radius of convergence is at least some number, we simply need to show convergence at some point by any method we know.

Example 11.3.2: Let us list some series we already know:

$$\begin{aligned} \sum_{n=0}^{\infty} z^n & \quad \text{has radius of convergence } 1. \\ \sum_{n=0}^{\infty} \frac{1}{n!} z^n & \quad \text{has radius of convergence } \infty. \\ \sum_{n=0}^{\infty} n^n z^n & \quad \text{has radius of convergence } 0. \end{aligned}$$

Example 11.3.3: Note the difference between $\frac{1}{1-z}$ and its power series. Let us expand $\frac{1}{1-z}$ as power series around a point $a \neq 1$. Let $c := \frac{1}{1-a}$, then

$$\frac{1}{1-z} = \frac{c}{1-c(z-a)} = c \sum_{n=0}^{\infty} c^n (z-a)^n = \sum_{n=0}^{\infty} \left(\frac{1}{(1-a)^{n+1}} \right) (z-a)^n.$$

The series $\sum c^n (z-a)^n$ converges if and only if the series on the right-hand side converges and

$$\limsup_{n \rightarrow \infty} \sqrt[n]{|c^n|} = |c| = \frac{1}{|1-a|}.$$

The radius of convergence of the power series is $|1-a|$, that is the distance from 1 to a . The function $\frac{1}{1-z}$ has a power series representation around every $a \neq 1$ and so is analytic in $\mathbb{C} \setminus \{1\}$. The domain of the function is bigger than the region of convergence of the power series representing the function at any point.

It turns out that if a function has a power series representation converging to the function on some ball, then it has a power series representation at every point in the ball. We will prove this result later.

11.3.3 Properties of analytic functions

Proposition 11.3.4. *If*

$$f(z) := \sum_{n=0}^{\infty} c_n (z-a)^n$$

is convergent in $B(a, \rho)$ for some $\rho > 0$, then $f: B(a, \rho) \rightarrow \mathbb{C}$ is continuous. In particular, analytic functions are continuous.

Proof. For $z_0 \in B(a, \rho)$, pick $r < \rho$ such that $z_0 \in B(a, r)$. On $B(a, r)$ the partial sums (which are continuous) converge uniformly, and so the limit $f|_{B(a, r)}$ is continuous. Any sequence converging to z_0 has some tail that is completely in the open ball $B(a, r)$, hence f is continuous at z_0 . \square

In Corollary 6.2.13 of volume I we proved that we can differentiate real power series term by term. That is we proved that if

$$f(x) := \sum_{n=0}^{\infty} c_n(x-a)^n$$

converges for real x in an interval around $a \in \mathbb{R}$, then we can differentiate term by term and obtain a series

$$f'(x) = \sum_{n=1}^{\infty} n c_n(x-a)^{n-1} = \sum_{n=0}^{\infty} (n+1) c_{n+1}(x-a)^n$$

with the same radius of convergence. We only proved this theorem when c_n is real, however, for complex c_n , we write $c_n = s_n + it_n$, and as x and a are real

$$\sum_{n=0}^{\infty} c_n(x-a)^n = \sum_{n=0}^{\infty} s_n(x-a)^n + i \sum_{n=0}^{\infty} t_n(x-a)^n.$$

We apply the theorem to the real and imaginary part.

By iterating this theorem we find that an analytic function is infinitely differentiable:

$$f^{(\ell)}(x) = \sum_{n=\ell}^{\infty} n(n-1)\cdots(n-\ell+1)c_n(x-a)^{n-\ell} = \sum_{n=0}^{\infty} (n+\ell)(n+\ell-1)\cdots(n+1)c_{n+\ell}(x-a)^n.$$

In particular,

$$f^{(\ell)}(a) = \ell! c_\ell. \quad (11.1)$$

So the coefficients are uniquely determined by the derivatives of the function, and vice versa.

On the other hand, just because we have an infinitely differentiable function doesn't mean that the numbers c_n obtained by $c_n = \frac{f^{(n)}(0)}{n!}$ give a convergent power series. There is a theorem, which we will not prove, that given an arbitrary sequence $\{c_n\}$, there exists an infinitely differentiable function f such that $c_n = \frac{f^{(n)}(0)}{n!}$. Moreover, even if the obtained series converges it may not converge to the function we started with. For an example, see Exercise 5.4.11 in volume I: The function

$$f(x) := \begin{cases} e^{-1/x} & \text{if } x > 0, \\ 0 & \text{if } x \leq 0, \end{cases}$$

is infinitely differentiable, and all derivatives at the origin are zero. So its series at the origin would be just the zero series, and while that series converges, it does not converge to f for $x > 0$.

Note that we can always apply an affine transformation $z \mapsto z + a$ that converts a power series to a series at the origin. That is, if

$$f(z) = \sum_{n=0}^{\infty} c_n(z-a)^n, \quad \text{we consider} \quad f(z+a) = \sum_{n=0}^{\infty} c_n z^n.$$

Therefore it is usually sufficient to prove results about power series at the origin. From now on, we often assume $a = 0$ for simplicity.

11.3.4 Power series as analytic functions

We need a theorem on swapping limits of series, that is, Fubini's theorem for sums.

Theorem 11.3.5 (Fubini for sums). *Let $\{a_{kj}\}_{k=1,j=1}^{\infty}$ be a double sequence of complex numbers and suppose that for every k the series*

$$\sum_{j=1}^{\infty} |a_{kj}| \quad \text{converges}$$

and furthermore that

$$\sum_{k=1}^{\infty} \left(\sum_{j=1}^{\infty} |a_{kj}| \right) \quad \text{converges.}$$

Then

$$\sum_{k=1}^{\infty} \left(\sum_{j=1}^{\infty} a_{kj} \right) = \sum_{j=1}^{\infty} \left(\sum_{k=1}^{\infty} a_{kj} \right),$$

where all the series involved converge.

Proof. Let E be the set $\{1/n : n \in \mathbb{N}\} \cup \{0\}$, and treat it as a metric space with the metric inherited from \mathbb{R} . Define the sequence of functions $f_k : E \rightarrow \mathbb{C}$ by

$$f_k(1/n) := \sum_{j=1}^n a_{kj} \quad \text{and} \quad f_k(0) := \sum_{j=1}^{\infty} a_{kj}.$$

As the series converges, each f_k is continuous at 0 (since 0 is the only cluster point, they are continuous at every point of E , but we don't need that). For all $x \in E$, we have

$$|f_k(x)| \leq \sum_{j=1}^{\infty} |a_{kj}|.$$

By knowing that $\sum_k \sum_j |a_{kj}|$ converges (and does not depend on x), we know that

$$\sum_{k=1}^n f_k(x)$$

converges uniformly on E . Define

$$g(x) := \sum_{k=1}^{\infty} f_k(x),$$

which is therefore a continuous function at 0. So

$$\begin{aligned} \sum_{k=1}^{\infty} \left(\sum_{j=1}^{\infty} a_{kj} \right) &= \sum_{k=1}^{\infty} f_k(0) = g(0) = \lim_{n \rightarrow \infty} g(1/n) \\ &= \lim_{n \rightarrow \infty} \sum_{k=1}^{\infty} f_k(1/n) = \lim_{n \rightarrow \infty} \sum_{k=1}^{\infty} \sum_{j=1}^n a_{kj} \\ &= \lim_{n \rightarrow \infty} \sum_{j=1}^n \sum_{k=1}^{\infty} a_{kj} = \sum_{j=1}^{\infty} \left(\sum_{k=1}^{\infty} a_{kj} \right). \end{aligned}$$

□

Now we prove that once we have a series converging to a function in some interval, we can expand the function around every point.

Theorem 11.3.6 (Taylor's theorem for real-analytic functions). *Let*

$$f(x) := \sum_{k=0}^{\infty} a_k x^k$$

be a power series converging in $(-\rho, \rho)$ for some $\rho > 0$. Given any $a \in (-\rho, \rho)$, and x such that $|x - a| < \rho - |a|$, we obtain

$$f(x) = \sum_{k=0}^{\infty} \frac{f^{(k)}(a)}{k!} (x - a)^k.$$

The power series at a could of course converge in a larger interval, but the one above is guaranteed. It is the largest symmetric interval about a that fits in $(-\rho, \rho)$.

Proof. Given a and x as in the theorem, write

$$\begin{aligned} f(x) &= \sum_{k=0}^{\infty} a_k ((x - a) + a)^k \\ &= \sum_{k=0}^{\infty} a_k \sum_{m=0}^k \binom{k}{m} a^{k-m} (x - a)^m. \end{aligned}$$

Define $c_{k,m} := a_k \binom{k}{m} a^{k-m}$ if $m \leq k$ and 0 if $m > k$. Then

$$f(x) = \sum_{k=0}^{\infty} \sum_{m=0}^{\infty} c_{k,m} (x - a)^m. \quad (11.2)$$

Let us show that the double sum converges absolutely.

$$\begin{aligned} \sum_{k=0}^{\infty} \sum_{m=0}^{\infty} |c_{k,m} (x - a)^m| &= \sum_{k=0}^{\infty} \sum_{m=0}^k |a_k \binom{k}{m} a^{k-m} (x - a)^m| \\ &= \sum_{k=0}^{\infty} |a_k| \sum_{m=0}^k \binom{k}{m} |a|^{k-m} |x - a|^m \\ &= \sum_{k=0}^{\infty} |a_k| (|x - a| + |a|)^k, \end{aligned}$$

and this series converges as long as $(|x - a| + |a|) < \rho$ or in other words if $|x - a| < \rho - |a|$.

Using [Theorem 11.3.5](#), swap the order of summation in (11.2), and the following series converges when $|x - a| < \rho - |a|$:

$$f(x) = \sum_{k=0}^{\infty} \sum_{m=0}^{\infty} c_{k,m} (x - a)^m = \sum_{m=0}^{\infty} \left(\sum_{k=0}^{\infty} c_{k,m} \right) (x - a)^m.$$

The formula in terms of derivatives at a follows by differentiating the series to obtain (11.1). \square

Note that if a series converges for real $x \in (a - \rho, a + \rho)$ it also converges for all complex numbers in $B(a, \rho)$. We have the following corollary, which says that functions defined by power series are analytic.

Corollary 11.3.7. *For every $a \in \mathbb{C}$, if $\sum c_k(z - a)^k$ converges to $f(z)$ in $B(a, \rho)$ and $b \in B(a, \rho)$, then there exists a power series $\sum d_k(z - b)^k$ that converges to $f(z)$ in $B(b, \rho - |b - a|)$.*

Proof. Without loss of generality assume that $a = 0$. We can rotate to assume that b is real, but since that is harder to picture, let us do it explicitly. Let $\alpha := \frac{\bar{b}}{|b|}$. Notice that

$$|1/\alpha| = |\alpha| = 1.$$

Therefore the series $\sum c_k(z/\alpha)^k = \sum c_k \alpha^{-k} z^k$ converges to $f(z/\alpha)$ in $B(0, \rho)$. When $z = x$ is real we apply [Theorem 11.3.6](#) at $|b|$ and get a series that converges to $f(z/\alpha)$ on $B(|b|, \rho - |b|)$. That is, there is a convergent series

$$f(z/\alpha) = \sum_{k=0}^{\infty} a_k(z - |b|)^k.$$

Using $\alpha b = |b|$, we find

$$f(z) = f(\alpha z/\alpha) = \sum_{k=0}^{\infty} a_k(\alpha z - |b|)^k = \sum_{k=0}^{\infty} a_k \alpha^k (z - |b|/\alpha)^k = \sum_{k=0}^{\infty} a_k \alpha^k (z - b)^k,$$

and this series converges for all z such that $|\alpha z - |b|| < \rho - |b|$ or $|z - b| < \rho - |b|$. \square

We proved above that a convergent power series is an analytic function where it converges. We have also shown before that $\frac{1}{1-z}$ is analytic outside of $z = 1$.

Note that just because a real analytic function is analytic on the entire real line it does not necessarily mean that it has a power series representation that converges everywhere. For example, the function

$$f(x) = \frac{1}{1+x^2}$$

happens to be real analytic function on \mathbb{R} (exercise). A power series around the origin converging to f has a radius of convergence of exactly 1. Can you see why? (exercise)

11.3.5 Identity theorem for analytic functions

Lemma 11.3.8. *Suppose $f(z) = \sum a_k z^k$ is a convergent power series and $\{z_n\}$ is a sequence of nonzero complex numbers converging to 0, such that $f(z_n) = 0$ for all n . Then $a_k = 0$ for every k .*

Proof. By continuity we know $f(0) = 0$ so $a_0 = 0$. Suppose there exists some nonzero a_k . Let m be the smallest m such that $a_m \neq 0$. Then

$$f(z) = \sum_{k=m}^{\infty} a_k z^k = z^m \sum_{k=m}^{\infty} a_k z^{k-m} = z^m \sum_{k=0}^{\infty} a_{k+m} z^k.$$

Write $g(z) = \sum_{k=0}^{\infty} a_{k+m} z^k$ (this series converges in on the same set as f). g is continuous and $g(0) = a_m \neq 0$. Thus there exists some $\delta > 0$ such that $g(z) \neq 0$ for all $z \in B(0, \delta)$. As $f(z) = z^m g(z)$, the only point in $B(0, \delta)$ where $f(z) = 0$ is when $z = 0$, but this contradicts the assumption that $f(z_n) = 0$ for all n . \square

Recall that in a metric space X , a *cluster point* (or sometimes *limit point*) of a set E is a point $p \in X$ such that $B(p, \varepsilon) \setminus \{p\}$ contains points of E for all $\varepsilon > 0$.

Theorem 11.3.9 (Identity theorem). *Let $U \subset \mathbb{C}$ be open and connected. If $f: U \rightarrow \mathbb{C}$ and $g: U \rightarrow \mathbb{C}$ are analytic functions that are equal on a set $E \subset U$, and E has a cluster point in U , then $f(z) = g(z)$ for all $z \in U$.*

In most common applications of this theorem E is an open set or perhaps a curve.

Proof. Without loss of generality suppose E is the set of all points $z \in U$ such that $g(z) = f(z)$. Note that E must be closed as f and g are continuous.

Suppose E has a cluster point. Without loss of generality assume that 0 is this cluster point. Near 0, we have the expansions

$$f(z) = \sum_{k=0}^{\infty} a_k z^k \quad \text{and} \quad g(z) = \sum_{k=0}^{\infty} b_k z^k,$$

which converge in some ball $B(0, \rho)$. Therefore the series

$$0 = f(z) - g(z) = \sum_{k=0}^{\infty} (a_k - b_k) z^k$$

converges in $B(0, \rho)$. As 0 is a cluster point of E , there is a sequence of nonzero points $\{z_n\}$ such that $f(z_n) - g(z_n) = 0$. Hence, by the lemma above $a_k = b_k$ for all k . Therefore, $B(0, \rho) \subset E$.

Thus the set of cluster points of E is open. The set of cluster points of E is also closed: A limit of cluster points of E is in E as it is closed, and it is clearly a cluster point of E . As U is connected, the set of cluster points of E is equal to U , or in other words $E = U$. \square

By restricting our attention to real x , we obtain the same theorem for connected open subsets of \mathbb{R} , which are just open intervals.

11.3.6 Exercises

Exercise 11.3.1: *Let*

$$a_{kj} := \begin{cases} 1 & \text{if } k = j, \\ -2^{k-j} & \text{if } k < j, \\ 0 & \text{if } k > j. \end{cases}$$

Compute (or show the limit doesn't exist):

$$a) \sum_{j=1}^{\infty} |a_{kj}| \text{ for every } k, \quad b) \sum_{k=1}^{\infty} |a_{kj}| \text{ for every } j, \quad c) \sum_{k=1}^{\infty} \sum_{j=1}^{\infty} |a_{kj}|, \quad d) \sum_{k=1}^{\infty} \sum_{j=1}^{\infty} a_{kj}, \quad e) \sum_{j=1}^{\infty} \sum_{k=1}^{\infty} a_{kj}.$$

Hint: Fubini for sums does not apply, in fact, answers to d) and e) are different.

Exercise 11.3.2: *Let $f(x) := \frac{1}{1+x^2}$. Prove that*

- f is analytic function on all of \mathbb{R} by finding a power series for f at every $a \in \mathbb{R}$,*
- the radius of convergence of the power series for f at the origin is 1.*

Exercise 11.3.3: Suppose $f: \mathbb{C} \rightarrow \mathbb{C}$ is analytic. Show that for each n , there are at most finitely many zeros of f in $B(0, n)$, that is, $f^{-1}(0) \cap B(0, n)$ is finite for each n .

Exercise 11.3.4: Suppose $U \subset \mathbb{C}$ is open and connected, $0 \in U$, and $f: U \rightarrow \mathbb{C}$ is analytic. Treating f as a function of a real x at the origin, suppose $f^{(n)}(0) = 0$ for all n . Show that $f(z) = 0$ for all $z \in U$.

Exercise 11.3.5: Suppose $U \subset \mathbb{C}$ is open and connected, $0 \in U$, and $f: U \rightarrow \mathbb{C}$ is analytic. For real x and y , let $h(x) := f(x)$ and $g(y) := -if(iy)$. Show that h and g are infinitely differentiable at the origin and $h'(0) = g'(0)$.

Exercise 11.3.6: Suppose a function f is analytic in some neighborhood of the origin, and that there exists an M such that $|f^{(n)}(0)| \leq M$ for all n . Prove that the series of f at the origin converges for all $z \in \mathbb{C}$.

Exercise 11.3.7: Suppose $f(z) := \sum c_n z^n$ with a radius of convergence 1. Suppose $f(0) = 0$, but f is not the zero function. Show that there exists a $k \in \mathbb{N}$ and a convergent power series $g(z) := \sum d_n z^n$ with radius of convergence 1 such that $f(z) = z^k g(z)$ for all $z \in B(0, 1)$, and $g(0) \neq 0$.

Exercise 11.3.8: Suppose $U \subset \mathbb{C}$ is open and connected. Suppose that $f: U \rightarrow \mathbb{C}$ is analytic, $U \cap \mathbb{R} \neq \emptyset$ and $f(x) = 0$ for all $x \in U \cap \mathbb{R}$. Show that $f(z) = 0$ for all $z \in U$.

Exercise 11.3.9: For $\alpha \in \mathbb{C}$ and $k = 0, 1, 2, 3, \dots$, define

$$\binom{\alpha}{k} := \frac{\alpha(\alpha-1)\cdots(\alpha-k)}{k!}.$$

a) Show that the series

$$f(z) := \sum_{k=0}^{\infty} \binom{\alpha}{k} z^k$$

converges whenever $|z| < 1$. In fact, prove that for $\alpha = 0, 1, 2, 3, \dots$ the radius of convergence is ∞ , and for all other α the radius of convergence is 1.

b) Show that for $x \in \mathbb{R}$, $|x| < 1$, we have

$$(1+x)f'(x) = \alpha f(x),$$

meaning that $f(x) = (1+x)^\alpha$.

Exercise 11.3.10: Suppose $f: \mathbb{C} \rightarrow \mathbb{C}$ is analytic and suppose that for some open interval $(a, b) \subset \mathbb{R}$, f is real valued on (a, b) . Show that f is real-valued on \mathbb{R} .

Exercise 11.3.11: Let $\mathbb{D} := B(0, 1)$ be the unit disc. Suppose $f: \mathbb{D} \rightarrow \mathbb{C}$ is analytic with power series $\sum c_n z^n$. Suppose $|c_n| \leq 1$ for all n . Prove that for all $z \in \mathbb{D}$, we have $|f(z)| \leq \frac{1}{1-|z|}$.

11.4 The complex exponential and the trigonometric functions

Note: 1 lecture

11.4.1 The complex exponential

Define

$$E(z) := \sum_{k=0}^{\infty} \frac{1}{k!} z^k.$$

This series converges for all $z \in \mathbb{C}$ and so by [Corollary 11.3.7](#), E is analytic on \mathbb{C} . We notice that $E(0) = 1$, and that for $z = x \in \mathbb{R}$, $E(x) \in \mathbb{R}$. Keeping x real, we find

$$\frac{d}{dx}(E(x)) = E(x)$$

by direct calculation. In §5.4 of volume I (or by Picard's theorem), we proved that the unique function satisfying $E' = E$ and $E(0) = 1$ is the exponential. In other words, for $x \in \mathbb{R}$, $e^x = E(x)$.

For complex numbers z , we define

$$e^z := E(z) = \sum_{k=0}^{\infty} \frac{1}{k!} z^k.$$

On the real line this new definition agrees with our previous one. See [Figure 11.7](#). Notice that in the x direction (the real direction) the graph behaves like the real exponential, and in the y direction (the imaginary direction) the graph oscillates.

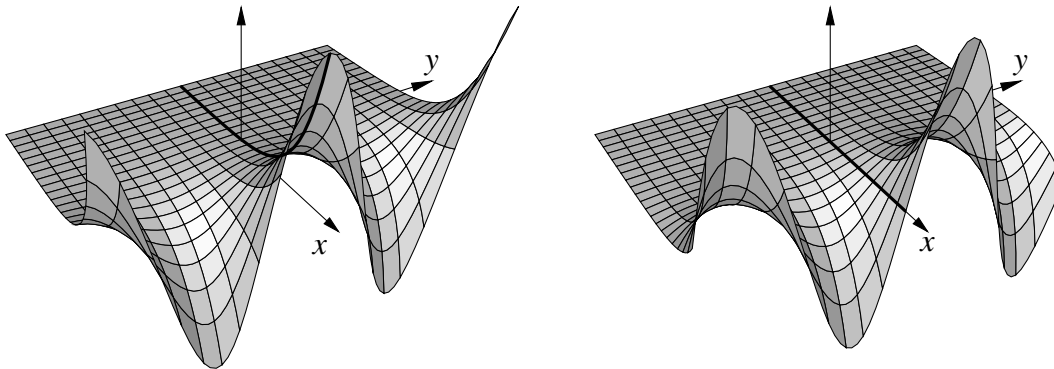

Figure 11.7: Graphs of the real part (left) and imaginary part (right) of the complex exponential $e^z = e^{x+iy}$. The x -axis goes from -4 to 4 , the y -axis goes from -6 to 6 , and the vertical axis goes from $-e^4 \approx -54.6$ to $e^4 \approx 54.6$. The plot of the real exponential ($y = 0$) is marked in a bold line.

Proposition 11.4.1. *Let $z, w \in \mathbb{C}$ be complex numbers. Then*

$$e^{z+w} = e^z e^w.$$

Proof. We already know that the equality $e^{x+y} = e^x e^y$ holds for all real numbers x and y . For every fixed $y \in \mathbb{R}$, consider the expressions as functions of x and apply the identity theorem (Theorem 11.3.9) to get that $e^{z+y} = e^z e^y$ for all $z \in \mathbb{C}$. Fixing an arbitrary $z \in \mathbb{C}$, we get $e^{z+y} = e^z e^y$ for all $y \in \mathbb{R}$. Again by the identity theorem $e^{z+w} = e^z e^w$ for all $w \in \mathbb{C}$. \square

A simple consequence is that $e^z \neq 0$ for all $z \in \mathbb{C}$, as $e^z e^{-z} = e^{z-z} = 1$. A more complicated consequence is that we can easily compute the power series for the exponential at a point $a \in \mathbb{C}$: $e^z = e^a e^{z-a} = \sum \frac{e^a}{k!} (z-a)^k$.

11.4.2 Trigonometric functions and π

We can now finally define *sine* and *cosine* by the equation

$$e^{x+iy} = e^x (\cos(y) + i \sin(y)).$$

In fact, we define sine and cosine for all complex z :

$$\cos(z) := \frac{e^{iz} + e^{-iz}}{2} \quad \text{and} \quad \sin(z) := \frac{e^{iz} - e^{-iz}}{2i}.$$

Let us use our definition to prove the common properties we usually associate with sine and cosine. In the process we also define the number π .

Proposition 11.4.2. *The sine and cosine functions have the following properties:*

(i) For all $z \in \mathbb{C}$,

$$e^{iz} = \cos(z) + i \sin(z) \quad (\text{Euler's formula}).$$

(ii) $\cos(0) = 1$, $\sin(0) = 0$.

(iii) For all $z \in \mathbb{C}$,

$$\cos(-z) = \cos(z), \quad \sin(-z) = -\sin(z).$$

(iv) For all $z \in \mathbb{C}$,

$$\cos(z) = \sum_{k=0}^{\infty} \frac{(-1)^k}{(2k)!} z^{2k}, \quad \sin(z) = \sum_{k=0}^{\infty} \frac{(-1)^k}{(2k+1)!} z^{2k+1}.$$

(v) For all $x \in \mathbb{R}$

$$\cos(x) = \operatorname{Re}(e^{ix}) \quad \text{and} \quad \sin(x) = \operatorname{Im}(e^{ix}).$$

(vi) For all $x \in \mathbb{R}$,

$$(\cos(x))^2 + (\sin(x))^2 = 1.$$

(vii) For all $x \in \mathbb{R}$,

$$|\sin(x)| \leq 1, \quad |\cos(x)| \leq 1.$$

(viii) For all $x \in \mathbb{R}$

$$\frac{d}{dx} [\cos(x)] = -\sin(x) \quad \text{and} \quad \frac{d}{dx} [\sin(x)] = \cos(x).$$

(ix) For all $x \geq 0$,

$$\sin(x) \leq x.$$

(x) There exists an $x > 0$ such that $\cos(x) = 0$. We define

$$\pi := 2 \inf\{x > 0 : \cos(x) = 0\}.$$

(xi) For all $z \in \mathbb{C}$,

$$e^{2\pi i} = 1, \quad \text{and} \quad e^{z+i2\pi} = e^z.$$

(xii) Sine and cosine are 2π -periodic and not periodic with any smaller period. That is, 2π is the smallest number such that for all $z \in \mathbb{C}$,

$$\sin(z + 2\pi) = \sin(z) \quad \text{and} \quad \cos(z + 2\pi) = \cos(z).$$

(xiii) The function $x \mapsto e^{ix}$ is a bijective map from $[0, 2\pi)$ onto the set of $z \in \mathbb{C}$ such that $|z| = 1$.

The proposition immediately implies that $\sin(x)$ and $\cos(x)$ are real whenever x is real.

Proof. The first three items follow directly from the definition. The computation of the power series for both is left as an exercise.

As complex conjugate is a continuous function, the definition of e^z implies $\overline{(e^z)} = e^{\bar{z}}$. If x is real,

$$\overline{(e^{ix})} = e^{-ix}.$$

Thus for real x , $\cos(x) = \operatorname{Re}(e^{ix})$ and $\sin(x) = \operatorname{Im}(e^{ix})$.

For real x we compute

$$1 = e^{ix}e^{-ix} = |e^{ix}|^2 = (\cos(x))^2 + (\sin(x))^2.$$

In particular, as e^{ix} is unimodular, the values lie on the unit circle. A square is always nonnegative:

$$(\sin(x))^2 = 1 - (\cos(x))^2 \leq 1.$$

So $|\sin(x)| \leq 1$ and similarly $|\cos(x)| \leq 1$.

We leave the computation of the derivatives to the reader as exercises.

Let us now prove that $\sin(x) \leq x$ for $x \geq 0$. Consider $f(x) := x - \sin(x)$ and differentiate:

$$f'(x) = \frac{d}{dx}[x - \sin(x)] = 1 - \cos(x) \geq 0,$$

for all x as $|\cos(x)| \leq 1$. In other words, f is increasing and $f(0) = 0$. So f must be nonnegative when $x \geq 0$.

We claim there exists a positive x such that $\cos(x) = 0$. As $\cos(0) = 1 > 0$, $\cos(x) > 0$ for x near 0. Namely, there is some $y > 0$, such that $\cos(x) > 0$ on $[0, y)$. Then $\sin(x)$ is strictly increasing on $[0, y)$. As $\sin(0) = 0$, then $\sin(x) > 0$ for $x \in (0, y)$. Take $a \in (0, y)$. By the mean value theorem there is a $c \in (a, y)$ such that

$$2 \geq \cos(a) - \cos(y) = \sin(c)(y - a) \geq \sin(a)(y - a).$$

As $a \in (0, y)$, then $\sin(a) > 0$ and so

$$y \leq \frac{2}{\sin(a)} + a.$$

Hence there is some largest y such that $\cos(x) > 0$ in $[0, y)$, and let y be the largest such number. By continuity, $\cos(y) = 0$. In fact, y is the smallest positive y such that $\cos(y) = 0$. As mentioned π is defined to be $2y$.

As $\cos(\pi/2) = 0$, then $(\sin(\pi/2))^2 = 1$. As \sin is positive on $(0, y)$, we have $\sin(\pi/2) = 1$. Hence,

$$e^{i\pi/2} = i,$$

and by the addition formula

$$e^{i\pi} = -1, \quad e^{i2\pi} = 1.$$

So $e^{i2\pi} = 1 = e^0$. The addition formula says

$$e^{z+i2\pi} = e^z$$

for all $z \in \mathbb{C}$. Immediately we also obtain $\cos(z + 2\pi) = \cos(z)$ and $\sin(z + 2\pi) = \sin(z)$. So \sin and \cos are 2π -periodic.

We claim that \sin and \cos are not periodic with a smaller period. It would suffice to show that if $e^{ix} = 1$ for the smallest positive x , then $x = 2\pi$. So let x be the smallest positive x such that $e^{ix} = 1$. Of course, $x \leq 2\pi$. By the addition formula,

$$(e^{ix/4})^4 = 1.$$

If $e^{ix/4} = a + ib$, then

$$(a + ib)^4 = a^4 - 6a^2b^2 + b^4 + i(4ab(a^2 - b^2)) = 1.$$

As $x/4 \leq \pi/2$, then $a = \cos(x/4) \geq 0$ and $0 < b = \sin(x/4)$. Then either $a = 0$ or $a^2 = b^2$. If $a^2 = b^2$, then $a^4 - 6a^2b^2 + b^4 = -4a^4 < 0$ and in particular not equal to 1. Therefore $a = 0$ in which case $x/4 = \pi/2$. Hence 2π is the smallest period we could choose for e^{ix} and so also for \cos and \sin .

Finally, we also wish to show that e^{ix} is one-to-one and onto from the set $[0, 2\pi)$ to the set of $z \in \mathbb{C}$ such that $|z| = 1$. Suppose $e^{ix} = e^{iy}$ and $x > y$. Then $e^{i(x-y)} = 1$, meaning $x - y$ is a multiple of 2π and hence only one of them can live in $[0, 2\pi)$. To show onto, pick $(a, b) \in \mathbb{R}^2$ such that $a^2 + b^2 = 1$. Suppose first that $a, b \geq 0$. By the intermediate value theorem there must exist an $x \in [0, \pi/2]$ such that $\cos(x) = a$, and hence $b^2 = (\sin(x))^2$. As b and $\sin(x)$ are nonnegative, we have $b = \sin(x)$. Since $-\sin(x)$ is the derivative of $\cos(x)$ and $\cos(-x) = \cos(x)$, then $\sin(x) < 0$ for $x \in [-\pi/2, 0)$. Using the same reasoning we obtain that if $a > 0$ and $b \leq 0$, we can find an x in $[-\pi/2, 0)$, and by periodicity, $x \in [3\pi/2, 2\pi)$ such that $\cos(x) = a$ and $\sin(x) = b$. Multiplying by -1 is the same as multiplying by $e^{i\pi}$ or $e^{-i\pi}$. So we can always assume that $a \geq 0$ (details are left as exercise). \square

11.4.3 The unit circle and polar coordinates

The arclength of a curve parametrized by $\gamma: [a, b] \rightarrow \mathbb{C}$ is given by

$$\int_a^b |\gamma'(t)| dt.$$

We have that e^{it} parametrizes the circle for t in $[0, 2\pi)$. As $\frac{d}{dt}(e^{it}) = ie^{it}$, the circumference of the circle (the arclength) is

$$\int_0^{2\pi} |ie^{it}| dt = \int_0^{2\pi} 1 dt = 2\pi.$$

More generally we notice that e^{it} parametrizes the circle by arclength. That is, t measures the arclength, and hence a circle of radius 1 by the angle in radians. So the definitions of \sin and \cos we have used above agree with the standard geometric definitions.

All the points on the unit circle can be achieved by e^{it} for some t . Therefore, we can write a complex number $z \in \mathbb{C}$ (in so-called *polar coordinates*) as

$$z = re^{i\theta}$$

for some $r \geq 0$ and $\theta \in \mathbb{R}$. The θ is, of course, not unique as θ or $\theta + 2\pi$ gives the same number. The formula $e^{a+b} = e^a e^b$ leads to a useful formula for powers and products of complex numbers in polar coordinates:

$$(re^{i\theta})^n = r^n e^{in\theta}, \quad (re^{i\theta})(se^{i\gamma}) = rse^{i(\theta+\gamma)}.$$

11.4.4 Exercises

Exercise 11.4.1: Derive the power series for $\sin(z)$ and $\cos(z)$ at the origin.

Exercise 11.4.2: Using the power series, show that for x real, we have $\frac{d}{dx}[\sin(x)] = \cos(x)$ and $\frac{d}{dx}[\cos(x)] = -\sin(x)$.

Exercise 11.4.3: Finish the proof of the argument that $x \mapsto e^{ix}$ from $[0, 2\pi)$ is onto the unit circle. In particular, assume that we get all points of the form (a, b) where $a^2 + b^2 = 1$ for $a \geq 0$. By multiplying by $e^{i\pi}$ or $e^{-i\pi}$ show that we get everything.

Exercise 11.4.4: Prove that there is no $z \in \mathbb{C}$ such that $e^z = 0$.

Exercise 11.4.5: Prove that for every $w \neq 0$ and every $\varepsilon > 0$, there exists a $z \in \mathbb{C}$, $|z| < \varepsilon$ such that $e^{1/z} = w$.

Exercise 11.4.6: We showed $(\cos(x))^2 + (\sin(x))^2 = 1$ for all $x \in \mathbb{R}$. Prove that $(\cos(z))^2 + (\sin(z))^2 = 1$ for all $z \in \mathbb{C}$.

Exercise 11.4.7: Prove the trigonometric identities $\sin(z+w) = \sin(z)\cos(w) + \cos(z)\sin(w)$ and $\cos(z+w) = \cos(z)\cos(w) - \sin(z)\sin(w)$ for all $z, w \in \mathbb{C}$.

Exercise 11.4.8: Define $\operatorname{sinc}(z) := \frac{\sin(z)}{z}$ for $z \neq 0$ and $\operatorname{sinc}(0) := 1$. Show that sinc is analytic and compute its power series at zero.

Define the *hyperbolic sine* and *hyperbolic cosine* by

$$\sinh(z) := \frac{e^z - e^{-z}}{2}, \quad \cosh(z) := \frac{e^z + e^{-z}}{2}.$$

Exercise 11.4.9: Derive the power series at the origin for the hyperbolic sine and cosine.

Exercise 11.4.10: Show

- $\sinh(0) = 0$, $\cosh(0) = 1$.
- $\frac{d}{dx}[\sinh(x)] = \cosh(x)$ and $\frac{d}{dx}[\cosh(x)] = \sinh(x)$.
- $\cosh(x) > 0$ for all $x \in \mathbb{R}$ and show that $\sinh(x)$ is strictly increasing and bijective from \mathbb{R} to \mathbb{R} .
- $(\cosh(x))^2 = 1 + (\sinh(x))^2$ for all x .

Exercise 11.4.11: Define $\tan(x) := \frac{\sin(x)}{\cos(x)}$ as usual.

- Show that for $x \in (-\pi/2, \pi/2)$ both \sin and \tan are strictly increasing, and hence \sin^{-1} and \tan^{-1} exist when we restrict to that interval.
- Show that \sin^{-1} and \tan^{-1} are differentiable and that $\frac{d}{dx} \sin^{-1}(x) = \frac{1}{\sqrt{1-x^2}}$ and $\frac{d}{dx} \tan^{-1}(x) = \frac{1}{1+x^2}$.
- Using the finite geometric sum formula show

$$\tan^{-1}(x) = \int_0^x \frac{1}{1+t^2} dt = \sum_{k=0}^{\infty} \frac{(-1)^k}{2k+1} x^{2k+1}$$

converges for all $-1 \leq x \leq 1$ (including the end points). Hint: Integrate the finite sum, not the series.

- Use this to show that

$$1 - \frac{1}{3} + \frac{1}{5} - \dots = \sum_{k=0}^{\infty} \frac{(-1)^k}{2k+1} = \frac{\pi}{4}.$$

11.5 Fundamental theorem of algebra

Note: half a lecture, optional

In this section we study the local behavior of polynomials and the growth of polynomials as z goes to infinity. As an application we prove the fundamental theorem of algebra: Any nonconstant polynomial has a complex root.

Lemma 11.5.1. *Let $p(z)$ be a nonconstant complex polynomial. If $p(z_0) \neq 0$, then there exist $w \in \mathbb{C}$ such that $|p(w)| < |p(z_0)|$. In fact, we can pick w to be arbitrarily close to z_0 .*

Proof. Without loss of generality assume that $z_0 = 0$ and $p(0) = 1$. Write

$$p(z) = 1 + a_k z^k + a_{k+1} z^{k+1} + \cdots + a_d z^d,$$

where $a_k \neq 0$. Pick t such that $a_k e^{ikt} = -|a_k|$, which we can do by the discussion on trigonometric functions. Suppose $r > 0$ is small enough such that $1 - r^k |a_k| > 0$. We have

$$p(re^{it}) = 1 - r^k |a_k| + r^{k+1} a_{k+1} e^{i(k+1)t} + \cdots + r^d a_d e^{idt}.$$

So

$$\begin{aligned} |p(re^{it})| - \left| r^{k+1} a_{k+1} e^{i(k+1)t} + \cdots + r^d a_d e^{idt} \right| &\leq \left| p(re^{it}) - r^{k+1} a_{k+1} e^{i(k+1)t} - \cdots - r^d a_d e^{idt} \right| \\ &= \left| 1 - r^k |a_k| \right| = 1 - r^k |a_k|. \end{aligned}$$

In other words,

$$|p(re^{it})| \leq 1 - r^k \left(|a_k| - r \left| a_{k+1} e^{i(k+1)t} + \cdots + r^{d-k-1} a_d e^{idt} \right| \right).$$

For small enough r , the expression in the parentheses is positive as $|a_k| > 0$. Hence, $|p(re^{it})| < 1 = p(0)$. \square

Remark 11.5.2. The lemma above holds essentially with an unchanged proof for (complex) analytic functions. A proof of this generalization is left as an exercise to the reader. What the lemma says is that the only minima the modulus of analytic functions (polynomials) has are precisely at the zeros.

Remark 11.5.3. The lemma does not hold if we restrict to real numbers. For example, $x^2 + 1$ has a minimum at $x = 0$, but no zero there. The thing is that there is a w arbitrarily close to 0 such that $|w^2 + 1| < 1$, but this w is necessarily not real. Letting $w = i\varepsilon$ for small $\varepsilon > 0$ works.

The moral of the story is that if $p(0) = 1$, then very close to 0, the polynomial looks like $1 + az^k$, and $1 + az^k$ has no minimum at the origin. All the higher powers of z are too small to make a difference. We find similar behavior at infinity.

Lemma 11.5.4. *Let $p(z)$ be a nonconstant complex polynomial. Then for an $M > 0$, there exists an $R > 0$ such that $|p(z)| \geq M$ whenever $|z| \geq R$.*

Proof. Write $p(z) = a_0 + a_1z + \cdots + a_dz^d$ and suppose that $d \geq 1$ and $a_d \neq 0$. Suppose $|z| \geq R$ (so also $|z|^{-1} \leq R^{-1}$). We estimate:

$$\begin{aligned} |p(z)| &\geq |a_dz^d| - |a_0| - |a_1z| - \cdots - |a_{d-1}z^{d-1}| \\ &= |z|^d (|a_d| - |a_0||z|^{-d} - |a_1||z|^{-d+1} - \cdots - |a_{d-1}||z|^{-1}) \\ &\geq R^d (|a_d| - |a_0|R^{-d} - |a_1|R^{1-d} - \cdots - |a_{d-1}|R^{-1}). \end{aligned}$$

Then the expression in parentheses is eventually positive for large enough R . In particular, for large enough R we get that this expression is greater than $\frac{|a_d|}{2}$, and so

$$|p(z)| \geq R^d \frac{|a_d|}{2}.$$

Therefore, we can pick R large enough to be bigger than a given M . □

The lemma above does *not* generalize to analytic functions, even those defined in all of \mathbb{C} . The function $\cos(z)$ is a counterexample. Note that we had to look at the term with the largest degree, and we only have such a term for a polynomial. In fact, something that we will not prove is that an analytic function defined on all of \mathbb{C} satisfying the conclusion of the lemma must be a polynomial.

The moral of the story here is that for very large $|z|$ (far away from the origin) a polynomial of degree d really looks like a constant multiple of z^d .

Theorem 11.5.5 (Fundamental theorem of algebra). *Let $p(z)$ be a nonconstant complex polynomial, then there exists a $z_0 \in \mathbb{C}$ such that $p(z_0) = 0$.*

Proof. Let $\mu := \inf\{|p(z)| : z \in \mathbb{C}\}$. Find an R such that for all z with $|z| \geq R$, we have $|p(z)| \geq \mu + 1$. Therefore, every z with $|p(z)|$ close to μ must be in the closed ball $C(0, R) = \{z \in \mathbb{C} : |z| \leq R\}$. As $|p(z)|$ is a continuous real-valued function, it achieves its minimum on the compact set $C(0, R)$ (closed and bounded) and this minimum must be μ . So there is a $z_0 \in C(0, R)$ such that $|p(z_0)| = \mu$. As that is a minimum of $|p(z)|$ on \mathbb{C} , then by the first lemma above, we have $|p(z_0)| = 0$. □

The fundamental theorem also does not generalize to analytic functions. For example, e^z is an analytic function on \mathbb{C} with no zeros.

11.5.1 Exercises

Exercise 11.5.1: Prove [Lemma 11.5.1](#) for an analytic function. That is, suppose that $p(z)$ is a power series around z_0 .

Exercise 11.5.2: Use [Exercise 11.5.1](#) to prove the maximum principle for analytic functions: If $U \subset \mathbb{C}$ is open and connected, $f: U \rightarrow \mathbb{C}$ is analytic, and $|f(z)|$ attains a relative maximum at $z_0 \in U$, then f is constant.

Exercise 11.5.3: Let $U \subset \mathbb{C}$ be open and $z_0 \in U$. Suppose $f: U \rightarrow \mathbb{C}$ is analytic and $f(z_0) = 0$. Show that there exists an $\varepsilon > 0$ such that either $f(z) \neq 0$ for all z with $0 < |z| < \varepsilon$ or $f(z) = 0$ for all $z \in B(z_0, \varepsilon)$. In other words, zeros of analytic functions are isolated. Of course, same holds for polynomials.

A *rational function* is a function $f(z) := \frac{p(z)}{q(z)}$ where p and q are polynomials and q is not identically zero. A point $z_0 \in \mathbb{C}$ where $f(z_0) = 0$ (and therefore $p(z_0) = 0$) is called a *zero*. A point $z_0 \in \mathbb{C}$ is called a *singularity* of f if $q(z_0) = 0$. As all zeros are isolated and so all singularities of rational functions are isolated and so are called an *isolated singularity*. An isolated singularity is called *removable* if $\lim_{z \rightarrow z_0} f(z)$ exists. An isolated singularity is called a *pole* if $\lim_{z \rightarrow z_0} |f(z)| = \infty$. We say f has pole at ∞ if

$$\lim_{z \rightarrow \infty} |f(z)| = \infty,$$

that is, if for every $M > 0$ there exists an $R > 0$ such that $|f(z)| > M$ for all z with $|z| > R$.

Exercise 11.5.4: Show that a rational function which is not identically zero has at most finitely many zeros and singularities. In fact, show that if p is a polynomial of degree $n > 0$ it has at most n zeros.

Hint: If z_0 is a zero of p , without loss of generality assume $z_0 = 0$. Then use induction.

Exercise 11.5.5: Prove that if z_0 is a removable singularity of a rational function $f(z) := \frac{p(z)}{q(z)}$, then there exist polynomials \tilde{p} and \tilde{q} such that $\tilde{q}(z_0) \neq 0$ and $f(z) = \frac{\tilde{p}(z)}{\tilde{q}(z)}$.

Hint: Without loss of generality assume $z_0 = 0$.

Exercise 11.5.6: Given a rational function f with an isolated singularity at z_0 , show that z_0 is either removable or a pole.

Hint: See the previous exercise.

Exercise 11.5.7: Let f be a rational function and $S \subset \mathbb{C}$ is the set of the singularities of f . Prove that f is equal to a polynomial on $\mathbb{C} \setminus S$ if and only if f has a pole at infinity and all the singularities are removable.

Hint: See previous exercises.

11.6 Equicontinuity and the Arzelà–Ascoli theorem

Note: 2 lectures

We would like an analogue of Bolzano–Weierstrass. Something to the tune of “every bounded sequence of functions (with some property) has a convergent subsequence.” Matters are not as simple even for continuous functions. Not every bounded sequence in the metric space $C([0, 1], \mathbb{R})$ has a convergent subsequence.

Definition 11.6.1. Let X be a set. Let $f_n: X \rightarrow \mathbb{C}$ be functions in a sequence. We say that $\{f_n\}$ is *pointwise bounded* if for every $x \in X$, there is an $M_x \in \mathbb{R}$ such that

$$|f_n(x)| \leq M_x \quad \text{for all } n \in \mathbb{N}.$$

We say that $\{f_n\}$ is *uniformly bounded* if there is an $M \in \mathbb{R}$ such that

$$|f_n(x)| \leq M \quad \text{for all } n \in \mathbb{N} \text{ and all } x \in X.$$

If X is a compact metric space, then a sequence in $C(X, \mathbb{C})$ is uniformly bounded if it is bounded as a set in the metric space $C(X, \mathbb{C})$ using the uniform norm.

Example 11.6.2: There exist sequences of continuous functions on $[0, 1]$ that are uniformly bounded but contain no subsequence converging even pointwise. Let us state without proof that $f_n(x) := \sin(2\pi nx)$ is one such sequence. Below we will show that there must always exist a subsequence converging at countably many points, but $[0, 1]$ is uncountable.

Example 11.6.3: The sequence $f_n(x) := x^n$ of continuous functions on $[0, 1]$ is uniformly bounded, but contains no subsequence that converges uniformly, although the sequence converges pointwise (to a discontinuous function).

Example 11.6.4: The sequence $\{f_n\}$ of functions in $C([0, 1], \mathbb{R})$ given by $f_n(x) := \frac{n^3 x}{1+n^4 x^2}$ converges pointwise to the zero function (obvious at $x = 0$, and for $x > 0$, we have $\frac{n^3 x}{1+n^4 x^2} \leq \frac{1}{nx}$). As for each x , $\{f_n(x)\}$ converges to 0, it is bounded so $\{f_n\}$ is pointwise bounded.

By calculus, we maximize f_n on $[0, 1]$, and we find the maximum occurs at the critical point $x = 1/n^2$:

$$\|f_n\|_u = f_n(1/n^2) = n/2.$$

So $\lim \|f_n\|_u = \infty$, and this sequence is not uniformly bounded.

When the domain is countable, we can locate a subsequence converging at least pointwise. The proof uses a very common and useful diagonal argument.

Proposition 11.6.5. *Let X be a countable set and $f_n: X \rightarrow \mathbb{C}$ give a pointwise bounded sequence of functions. Then $\{f_n\}$ has a subsequence that converges pointwise.*

Proof. Let x_1, x_2, x_3, \dots be an enumeration of the elements of X . The sequence $\{f_n(x_1)\}_{n=1}^\infty$ is bounded and hence we have a subsequence of $\{f_n\}_{n=1}^\infty$, which we denote by $\{f_{1,k}\}_{k=1}^\infty$, such that $\{f_{1,k}(x_1)\}_{k=1}^\infty$ converges. Next $\{f_{1,k}(x_2)\}_{k=1}^\infty$ is bounded and so $\{f_{1,k}\}_{k=1}^\infty$ has a subsequence $\{f_{2,k}\}_{k=1}^\infty$ such that $\{f_{2,k}(x_2)\}_{k=1}^\infty$ converges. Note that $\{f_{2,k}(x_1)\}_{k=1}^\infty$ is still convergent.

In general, we have a sequence $\{f_{m,k}\}_{k=1}^{\infty}$, which is a subsequence of $\{f_{m-1,k}\}_{k=1}^{\infty}$, such that $\{f_{m,k}(x_j)\}_{k=1}^{\infty}$ converges for $j = 1, 2, \dots, m$. We let $\{f_{m+1,k}\}_{k=1}^{\infty}$ be a subsequence of $\{f_{m,k}\}_{k=1}^{\infty}$ such that $\{f_{m+1,k}(x_{m+1})\}_{k=1}^{\infty}$ converges (and hence it converges for all x_j for $j = 1, 2, \dots, m+1$). Rinse and repeat.

If X is finite, we are done as the process stops at some point. If X is countably infinite, we pick the sequence $\{f_{k,k}\}_{k=1}^{\infty}$. This is a subsequence of the original sequence $\{f_n\}_{n=1}^{\infty}$. For every m , the tail $\{f_{k,k}\}_{k=m}^{\infty}$ is a subsequence of $\{f_{m,k}\}_{k=1}^{\infty}$ and hence for any m the sequence $\{f_{k,k}(x_m)\}_{k=1}^{\infty}$ converges. \square

For larger than countable sets, we need the functions of the sequence to be related. When we look at continuous functions, the concept we need is equicontinuity.

Definition 11.6.6. Let (X, d) be a metric space. A set S of functions $f: X \rightarrow \mathbb{C}$ is *uniformly equicontinuous* if for every $\varepsilon > 0$, there is a $\delta > 0$ such that if $x, y \in X$ with $d(x, y) < \delta$, we have

$$|f(x) - f(y)| < \varepsilon \quad \text{for all } f \in S.$$

Notice that functions in a uniformly equicontinuous sequence are all uniformly continuous. It is not hard to show that a finite set of uniformly continuous functions is uniformly equicontinuous. The definition is really interesting if S is infinite.

Just as for continuity, one can define equicontinuity at a point. That is, S is *equicontinuous at $x \in X$* if for every $\varepsilon > 0$, there is a $\delta > 0$ such that for $y \in X$ with $d(x, y) < \delta$, we have $|f(x) - f(y)| < \varepsilon$ for all $f \in S$. We will only deal with compact X here, and one can prove (exercise) that for a compact metric space X , if S is equicontinuous at every $x \in X$, then it is uniformly equicontinuous. For simplicity we stick to uniform equicontinuity.

Proposition 11.6.7. Suppose (X, d) is a compact metric space, $f_n \in C(X, \mathbb{C})$, and $\{f_n\}$ converges uniformly, then $\{f_n\}$ is uniformly equicontinuous.

Proof. Let $\varepsilon > 0$ be given. As $\{f_n\}$ converges uniformly, there is an $N \in \mathbb{N}$ such that for all $n \geq N$

$$|f_n(x) - f_N(x)| < \varepsilon/3 \quad \text{for all } x \in X.$$

As X is compact, every continuous function is uniformly continuous. So $\{f_1, f_2, \dots, f_N\}$ is a finite set of uniformly continuous functions. And so, as we mentioned above, the set is uniformly equicontinuous. Hence there is a $\delta > 0$ such that

$$|f_j(x) - f_j(y)| < \varepsilon/3 < \varepsilon$$

whenever $d(x, y) < \delta$ and $1 \leq j \leq N$.

Take $n > N$. For $d(x, y) < \delta$, we have

$$|f_n(x) - f_n(y)| \leq |f_n(x) - f_N(x)| + |f_N(x) - f_N(y)| + |f_N(y) - f_n(y)| < \varepsilon/3 + \varepsilon/3 + \varepsilon/3 = \varepsilon. \quad \square$$

Proposition 11.6.8. A compact metric space (X, d) contains a countable dense subset, that is, there exists a countable $D \subset X$ such that $\bar{D} = X$.

Proof. For each $n \in \mathbb{N}$ there are finitely many balls of radius $1/n$ that cover X (as X is compact). That is, for every n , there exists a finite set of points $x_{n,1}, x_{n,2}, \dots, x_{n,k_n}$ such that

$$X = \bigcup_{j=1}^{k_n} B(x_{n,j}, 1/n).$$

Let $D := \bigcup_{n=1}^{\infty} \{x_{n,1}, x_{n,2}, \dots, x_{n,k_n}\}$. The set D is countable as it is a countable union of finite sets. For every $x \in X$ and every $\varepsilon > 0$, there exists an n such that $1/n < \varepsilon$ and an $x_{n,j} \in D$ such that

$$x \in B(x_{n,j}, 1/n) \subset B(x_{n,j}, \varepsilon).$$

Hence $x \in \bar{D}$, so $\bar{D} = X$ and D is dense. □

We are now ready for the main result of this section, the Arzelà–Ascoli theorem* about existence of convergent subsequences.

Theorem 11.6.9 (Arzelà–Ascoli). *Let (X, d) be a compact metric space, and let $\{f_n\}$ be pointwise bounded and uniformly equicontinuous sequence of functions $f_n \in C(X, \mathbb{C})$. Then $\{f_n\}$ is uniformly bounded and $\{f_n\}$ contains a uniformly convergent subsequence.*

Basically, a uniformly equicontinuous sequence in the metric space $C(X, \mathbb{C})$ that is pointwise bounded is bounded (in $C(X, \mathbb{C})$) and furthermore contains a convergent subsequence in $C(X, \mathbb{C})$.

As we mentioned before, as X is compact, it is enough to just assume that $\{f_n\}$ is equicontinuous as uniform equicontinuity is automatic via an exercise.

Proof. Let us first show that the sequence is uniformly bounded.

By uniform equicontinuity, there is a $\delta > 0$ such that for all $x \in X$ and all $n \in \mathbb{N}$,

$$B(x, \delta) \subset f_n^{-1}(B(f_n(x), 1)).$$

The space X is compact, so there exist x_1, x_2, \dots, x_k such that

$$X = \bigcup_{j=1}^k B(x_j, \delta).$$

As $\{f_n\}$ is pointwise bounded there exist M_1, M_2, \dots, M_k such that for $j = 1, 2, \dots, k$, we have

$$|f_n(x_j)| \leq M_j \quad \text{for all } n.$$

Let $M := 1 + \max\{M_1, M_2, \dots, M_k\}$. Given any $x \in X$, there is a j such that $x \in B(x_j, \delta)$. Therefore, for all n , we have $x \in f_n^{-1}(B(f_n(x_j), 1))$, or in other words

$$|f_n(x) - f_n(x_j)| < 1.$$

By reverse triangle inequality,

$$|f_n(x)| < 1 + |f_n(x_j)| \leq 1 + M_j \leq M.$$

*Named after the Italian mathematicians [Cesare Arzelà](#) (1847–1912), and [Giulio Ascoli](#) (1843–1896).

And as x was arbitrary, $\{f_n\}$ is uniformly bounded.

Next, pick a countable dense subset $D \subset X$. By [Proposition 11.6.5](#), we find a subsequence $\{f_{n_j}\}$ that converges pointwise on D . Write $g_j := f_{n_j}$ for simplicity. The sequence $\{g_n\}$ is uniformly equicontinuous. Let $\varepsilon > 0$ be given, then there exists a $\delta > 0$ such that for all $x \in X$ and all $n \in \mathbb{N}$

$$B(x, \delta) \subset g_n^{-1}(B(g_n(x), \varepsilon/3)).$$

By density of D and because δ is fixed, every $x \in X$ is in some $B(y, \delta)$ for some $y \in D$. By compactness of X , there is a finite subset $\{x_1, x_2, \dots, x_k\} \subset D$ such that

$$X = \bigcup_{j=1}^k B(x_j, \delta).$$

As there are finitely many points and $\{g_n\}$ converges pointwise on D , there exists a single N such that for all $n, m \geq N$, we have

$$|g_n(x_j) - g_m(x_j)| < \varepsilon/3 \quad \text{for all } j = 1, 2, \dots, k.$$

Let $x \in X$ be arbitrary. There is some j such that $x \in B(x_j, \delta)$ and so for all $\ell \in \mathbb{N}$,

$$|g_\ell(x) - g_\ell(x_j)| < \varepsilon/3.$$

So for $n, m \geq N$,

$$|g_n(x) - g_m(x)| \leq |g_n(x) - g_n(x_j)| + |g_n(x_j) - g_m(x_j)| + |g_m(x_j) - g_m(x)| < \varepsilon/3 + \varepsilon/3 + \varepsilon/3 = \varepsilon.$$

Hence, the sequence is uniformly Cauchy. By completeness of \mathbb{C} , it is uniformly convergent. \square

Corollary 11.6.10. *Let (X, d) be a compact metric space. Let $S \subset C(X, \mathbb{C})$ be a closed, bounded and uniformly equicontinuous set. Then S is compact.*

The theorem says that S is sequentially compact and that means compact in a metric space. Recall that the closed unit ball in $C([0, 1], \mathbb{R})$ (and therefore also in $C([0, 1], \mathbb{C})$) is not compact. Hence it cannot be a uniformly equicontinuous set.

Corollary 11.6.11. *Suppose $\{f_n\}$ is a sequence of differentiable functions on $[a, b]$, $\{f'_n\}$ is uniformly bounded, and there is an $x_0 \in [a, b]$ such that $\{f_n(x_0)\}$ is bounded. Then there exists a uniformly convergent subsequence $\{f_{n_j}\}$.*

Proof. The trick is to use the mean value theorem. If M is the uniform bound on $\{f'_n\}$, then by the mean value theorem for every n

$$|f_n(x) - f_n(y)| \leq M|x - y| \quad \text{for all } x, y \in X.$$

All the f_n are Lipschitz with the same constant and hence the sequence is uniformly equicontinuous.

Suppose $|f_n(x_0)| \leq M_0$ for all n . For all $x \in [a, b]$,

$$|f_n(x)| \leq |f_n(x_0)| + |f_n(x) - f_n(x_0)| \leq M_0 + M|x - x_0| \leq M_0 + M(b - a).$$

So $\{f_n\}$ is uniformly bounded. We apply [Arzelà–Ascoli](#) to find the subsequence. \square

A classic application of the corollary above to Arzelà–Ascoli in the theory of differential equations is to prove the Peano existence theorem, that is, the existence of solutions to ordinary differential equations. See [Exercise 11.6.11](#) below.

Another application of Arzelà–Ascoli using the same idea as the corollary above is the following. Take a continuous $k: [0, 1] \times [0, 1] \rightarrow \mathbb{C}$. For every $f \in C([0, 1], \mathbb{C})$ define

$$T(f)(x) := \int_0^1 f(t)k(x,t) dt.$$

In exercises to earlier sections you have shown that T is a linear operator on $C([0, 1], \mathbb{C})$. Via Arzelà–Ascoli, we also find (exercise) that the image of the unit ball of functions

$$T(B(0, 1)) = \{Tf \in C([0, 1], \mathbb{C}) : \|f\|_u < 1\}$$

has compact closure, usually called *relatively compact*. Such an operator is called a *compact operator*. And they are very useful. Generally operators defined by integration tend to be compact.

11.6.1 Exercises

Exercise 11.6.1: Let $f_n: [-1, 1] \rightarrow \mathbb{R}$ be given by $f_n(x) := \frac{nx}{1+(nx)^2}$. Prove that the sequence is uniformly bounded, converges pointwise to 0, yet there is no subsequence that converges uniformly. Which hypothesis of Arzelà–Ascoli is not satisfied? Prove your assertion.

Exercise 11.6.2: Define $f_n: \mathbb{R} \rightarrow \mathbb{R}$ by $f_n(x) := \frac{1}{(x-n)^2+1}$. Prove that this sequence is uniformly bounded, uniformly equicontinuous, the sequence converges pointwise to zero, yet there is no subsequence that converges uniformly. Which hypothesis of Arzelà–Ascoli is not satisfied? Prove your assertion.

Exercise 11.6.3: Let (X, d) be a compact metric space, $C > 0$, $0 < \alpha \leq 1$, and suppose $f_n: X \rightarrow \mathbb{C}$ are functions such as $|f_n(x) - f_n(y)| \leq Cd(x, y)^\alpha$ for all $x, y \in X$ and $n \in \mathbb{N}$. Suppose also that there is a point $p \in X$ such that $f_n(p) = 0$ for all n . Show that there exists a uniformly convergent subsequence converging to an $f: X \rightarrow \mathbb{C}$ that also satisfies $f(p) = 0$ and $|f(x) - f(y)| \leq Cd(x, y)^\alpha$.

Exercise 11.6.4: Let $T: C([0, 1], \mathbb{C}) \rightarrow C([0, 1], \mathbb{C})$ be the operator given by

$$T(f)(x) := \int_0^x f(t) dt.$$

(That T is linear and that Tf is continuous follows from linearity of the integral and the fundamental theorem of calculus.)

a) Show that T takes the unit ball centered at 0 in $C([0, 1], \mathbb{C})$ into a relatively compact set (a set with compact closure). That is, T is a compact operator.

Hint: See [Exercise 7.4.20](#) in volume I.

b) Let $C \subset C([0, 1], \mathbb{C})$ the closed unit ball, prove that the image $T(C)$ is not closed (though it is relatively compact).

Exercise 11.6.5: Given $k \in C([0, 1] \times [0, 1], \mathbb{C})$, let $T: C([0, 1], \mathbb{C}) \rightarrow C([0, 1], \mathbb{C})$ be the operator defined by

$$T(f)(x) := \int_0^1 f(t)k(x,t) dt.$$

Show that T takes the unit ball centered at 0 in $C([0, 1], \mathbb{C})$ into a relatively compact set (a set with compact closure). That is, T is a compact operator.

Hint: See [Exercise 7.4.20](#) in volume I.

Note: That T is a well-defined linear operator was proved in [Exercise 8.1.6](#).

Exercise 11.6.6: Suppose $S^1 \subset \mathbb{C}$ is the unit circle, that is the set where $|z| = 1$. Suppose the continuous functions $f_n: S^1 \rightarrow \mathbb{C}$ are uniformly bounded. Let $\gamma: [0, 1] \rightarrow S^1$ be a parametrization of S^1 , and $g(z, w)$ a continuous function on $C(0, 1) \times S^1$ (here $C(0, 1) \subset \mathbb{C}$ is the closed unit ball). Define the functions $F_n: C(0, 1) \rightarrow \mathbb{C}$ by the path integral (see §9.2)

$$F_n(z) := \int_{\gamma} f_n(w) g(z, w) ds(w).$$

Show that $\{F_n\}$ has a uniformly convergent subsequence.

Exercise 11.6.7: Suppose (X, d) is a compact metric space, $\{f_n\}$ a uniformly equicontinuous sequence of functions in $C(X, \mathbb{C})$. Suppose $\{f_n\}$ converges pointwise. Show that it converges uniformly.

Exercise 11.6.8: Suppose that $\{f_n\}$ is a uniformly equicontinuous uniformly bounded sequence of 2π -periodic functions $f_n: \mathbb{R} \rightarrow \mathbb{R}$. Show that there is a uniformly convergent subsequence.

Exercise 11.6.9: Show that for a compact metric space X , a sequence $\{f_n\}$ that is equicontinuous at every $x \in X$ is uniformly equicontinuous.

Exercise 11.6.10: Define $f_n: [0, 1] \rightarrow \mathbb{C}$ by $f_n(t) := e^{i(2\pi t + n)}$. This is a uniformly equicontinuous uniformly bounded sequence. Prove more than just the conclusion of Arzelà–Ascoli for this sequence. Let $\gamma \in \mathbb{R}$ be given, and define $g(t) := e^{i(2\pi t + \gamma)}$. Show that there exists a subsequence of $\{f_n\}$ converging uniformly to g . Hint: Feel free to use the Kronecker density theorem*: The sequence $\{e^{in}\}_{n=1}^{\infty}$ is dense in the unit circle.

Exercise 11.6.11: Prove the Peano existence theorem (note the weaker hypotheses than Picard, but also the lack of uniqueness in this theorem):

Theorem: Suppose $F: I \times J \rightarrow \mathbb{R}$ is a continuous function where $I, J \subset \mathbb{R}$ are closed bounded intervals, let I° and J° be their interiors, and let $(x_0, y_0) \in I^\circ \times J^\circ$. Then there exists an $h > 0$ and a differentiable function $f: [x_0 - h, x_0 + h] \rightarrow J \subset \mathbb{R}$, such that

$$f'(x) = F(x, f(x)) \quad \text{and} \quad f(x_0) = y_0.$$

Use the following outline:

a) We wish to define the Picard iterates, that is, set $f_0(x) := y_0$, and

$$f_{n+1}(x) := y_0 + \int_{x_0}^x F(t, f_n(t)) dt.$$

Prove that there exists an $h > 0$ such that $f_n: [x_0 - h, x_0 + h] \rightarrow \mathbb{C}$ is well-defined for all n . Hint: F is bounded (why?).

b) Show that $\{f_n\}$ is equicontinuous and bounded, in fact it is Lipschitz with a uniform Lipschitz constant. Arzelà–Ascoli then says that there exists a uniformly convergent subsequence $\{f_{n_k}\}$.

c) Prove $\{F(x, f_{n_k}(x))\}_{k=1}^{\infty}$ converges uniformly on $[x_0 - h, x_0 + h]$. Hint: F is uniformly continuous (why?).

d) Finish the proof of the theorem by taking the limit under the integral and applying the fundamental theorem of calculus.

*Named after the German mathematician [Leopold Kronecker](#) (1823–1891).

11.7 The Stone–Weierstrass theorem

Note: 3 lectures

11.7.1 Weierstrass approximation

Perhaps surprisingly, even a very badly behaved continuous function is a uniform limit of polynomials. And we cannot really get any “nicer” functions than polynomials. The idea of the proof is a very common approximation or “smoothing” idea (convolution with an approximate delta function) that has applications far beyond pure mathematics.

Theorem 11.7.1 (Weierstrass approximation theorem). *If $f: [a, b] \rightarrow \mathbb{C}$ is continuous, then there exists a sequence $\{p_n\}$ of polynomials converging to f uniformly on $[a, b]$. Furthermore, if f is real-valued, we can find p_n with real coefficients.*

Proof. For $x \in [0, 1]$ define

$$g(x) := f((b-a)x+a) - f(a) - x(f(b) - f(a)).$$

If we prove the theorem for g and find the sequence $\{p_n\}$ for g , it is proved for f as we simply composed with an invertible affine function and added an affine function to f : We reverse the process and apply that to our p_n , to obtain polynomials approximating f .

The function g is defined on $[0, 1]$ and $g(0) = g(1) = 0$. For simplicity, assume that g is defined on the whole real line by letting $g(x) := 0$ if $x < 0$ or $x > 1$. This extended g is continuous.

Define

$$c_n := \left(\int_{-1}^1 (1-x^2)^n dx \right)^{-1}, \quad q_n(x) := c_n(1-x^2)^n.$$

The choice of c_n is so that $\int_{-1}^1 q_n(x) dx = 1$. See [Figure 11.8](#).

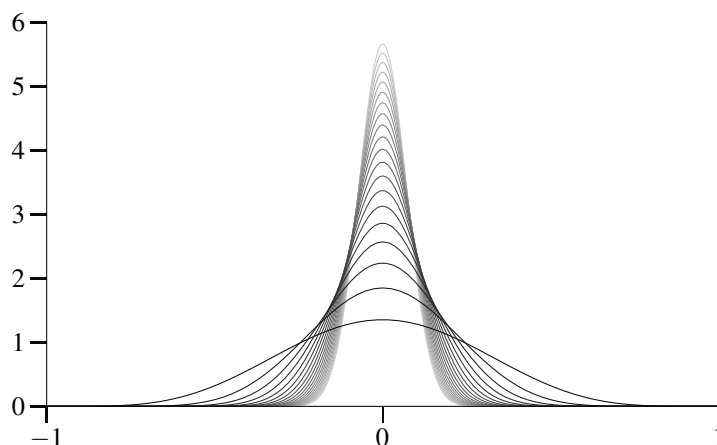

Figure 11.8: Plot of the approximate delta functions q_n on $[-1, 1]$ for $n = 5, 10, 15, 20, \dots, 100$ with higher n in lighter shade.

The functions q_n are peaks around 0 (ignoring what happens outside of $[-1, 1]$) that get narrower and taller as n increases, while the area underneath is always 1. A classic approximation idea is to do a *convolution* integral with peaks like this: For for $x \in [0, 1]$, let

$$p_n(x) := \int_0^1 g(t)q_n(x-t) dt \quad \left(= \int_{-\infty}^{\infty} g(t)q_n(x-t) dt \right).$$

The idea of this convolution is that we do a “weighted average” of the function g around the point x using q_n as the weight. See [Figure 11.9](#).

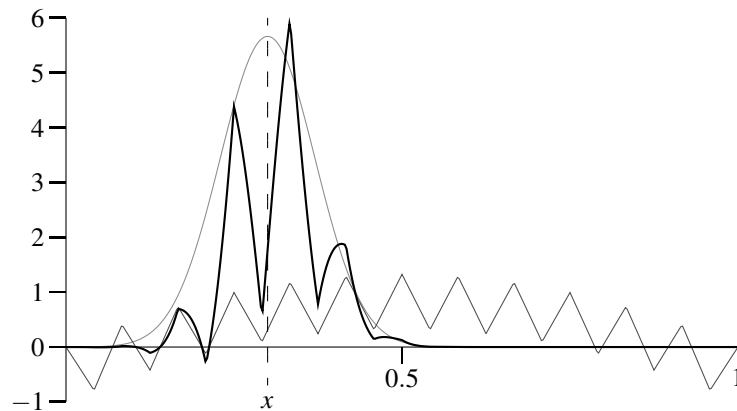

Figure 11.9: For $x = 0.3$, the plot of $q_{100}(x-t)$ (light gray peak centered at x), some continuous function $g(t)$ (the jagged line) and the product $g(t)q_{100}(x-t)$ (the bold line).

As q_n is a narrow peak, the integral mostly sees the values of g that are close to x and it does the weighted average of them. When the peak gets narrower, we compute this average closer to x and we expect the result to get closer to the value of $g(x)$. Really we are approximating what is called a delta function* (don’t worry if you have not heard of this concept), and functions like q_n are often called *approximate delta functions*. We could do this with any set of polynomials that look like narrower and narrower peaks near zero. These just happen to be the simplest ones. We only need this behavior on $[-1, 1]$ as the convolution sees nothing further than this as g is zero outside $[0, 1]$.

Because q_n is a polynomial we write

$$q_n(x-t) = a_0(t) + a_1(t)x + \cdots + a_{2n}(t)x^{2n},$$

where $a_k(t)$ are polynomials in t , in particular continuous and hence integrable functions. So

$$\begin{aligned} p_n(x) &= \int_0^1 g(t)q_n(x-t) dt \\ &= \left(\int_0^1 g(t)a_0(t) dt \right) + \left(\int_0^1 g(t)a_1(t) dt \right) x + \cdots + \left(\int_0^1 g(t)a_{2n}(t) dt \right) x^{2n}. \end{aligned}$$

In other words, p_n is a polynomial[†] in x . If $g(t)$ is real-valued, then the functions $g(t)a_j(t)$ are real-valued and hence p_n has real coefficients, proving the “furthermore” part of the theorem.

*The delta function is not actually a function.

†Do note that the functions a_j depend on n , so the coefficients of p_n change as n changes.

We still need to prove that $\{p_n\}$ converges to g . First let us get some handle on the size of c_n . For $x \in [0, 1]$, we have that $1 - x \leq 1 - x^2$. We estimate

$$\begin{aligned} c_n^{-1} &= \int_{-1}^1 (1 - x^2)^n dx = 2 \int_0^1 (1 - x^2)^n dx \\ &\geq 2 \int_0^1 (1 - x)^n dx = \frac{2}{n+1}. \end{aligned}$$

So $c_n \leq \frac{n+1}{2} \leq n$.

Let us see how small q_n is, if we ignore some small interval around the origin, which is where the peak is. Given any $\delta > 0$, $\delta < 1$, for x such that $\delta \leq |x| \leq 1$, we have

$$q_n(x) \leq c_n(1 - \delta^2)^n \leq n(1 - \delta^2)^n,$$

because q_n is increasing on $[-1, 0]$ and decreasing on $[0, 1]$. By the ratio test, $n(1 - \delta^2)^n$ goes to 0 as n goes to infinity.

The function q_n is even, $q_n(t) = q_n(-t)$, and g is zero outside of $[0, 1]$. So for $x \in [0, 1]$,

$$p_n(x) = \int_0^1 g(t)q_n(x-t) dt = \int_{-x}^{1-x} g(x+t)q_n(-t) dt = \int_{-1}^1 g(x+t)q_n(t) dt.$$

Let $\varepsilon > 0$ be given. As $[-1, 2]$ is compact and g is continuous on $[-1, 2]$, we have that g is uniformly continuous. Pick $0 < \delta < 1$ such that if $|x - y| < \delta$ (and $x, y \in [-1, 2]$), then

$$|g(x) - g(y)| < \frac{\varepsilon}{2}.$$

Let M be such that $|g(x)| \leq M$ for all x . Let N be such that for all $n \geq N$,

$$4Mn(1 - \delta^2)^n < \frac{\varepsilon}{2}.$$

Note that $\int_{-1}^1 q_n(t) dt = 1$ and $q_n(t) \geq 0$ on $[-1, 1]$. So for $n \geq N$ and every $x \in [0, 1]$,

$$\begin{aligned} |p_n(x) - g(x)| &= \left| \int_{-1}^1 g(x+t)q_n(t) dt - g(x) \int_{-1}^1 q_n(t) dt \right| \\ &= \left| \int_{-1}^1 (g(x+t) - g(x))q_n(t) dt \right| \\ &\leq \int_{-1}^1 |g(x+t) - g(x)|q_n(t) dt \\ &= \int_{-1}^{-\delta} |g(x+t) - g(x)|q_n(t) dt + \int_{-\delta}^{\delta} |g(x+t) - g(x)|q_n(t) dt \\ &\quad + \int_{\delta}^1 |g(x+t) - g(x)|q_n(t) dt \\ &\leq 2M \int_{-1}^{-\delta} q_n(t) dt + \frac{\varepsilon}{2} \int_{-\delta}^{\delta} q_n(t) dt + 2M \int_{\delta}^1 q_n(t) dt \\ &\leq 2Mn(1 - \delta^2)^n(1 - \delta) + \frac{\varepsilon}{2} + 2Mn(1 - \delta^2)^n(1 - \delta) \\ &< 4Mn(1 - \delta^2)^n + \frac{\varepsilon}{2} < \varepsilon. \end{aligned}$$

□

A convolution often inherits some property of the functions we are convolving. In our case the convolution p_n inherited the property of being a polynomial from q_n . The same idea of the proof is often used to get other properties. If q_n or g is infinitely differentiable, so is p_n . If q_n or g is a solution to a linear differential equation, so is p_n . Etc.

Let us note an immediate application of the Weierstrass theorem. We have already seen that countable dense subsets can be very useful.

Corollary 11.7.2. *The metric space $C([a, b], \mathbb{C})$ contains a countable dense subset.*

Proof. Without loss of generality suppose that we are dealing with $C([a, b], \mathbb{R})$ (why?). The real polynomials are dense in $C([a, b], \mathbb{R})$ by Weierstrass. If we show that every real polynomial can be approximated by polynomials with rational coefficients, we are done. This is because there are only countably many rational numbers and so there are only countably many polynomials with rational coefficients (a countable union of countable sets is still countable).

Further without loss of generality, suppose $[a, b] = [0, 1]$. Let

$$p(x) := \sum_{k=0}^n a_k x^k$$

be a polynomial of degree n where $a_k \in \mathbb{R}$. Given $\varepsilon > 0$, pick $b_k \in \mathbb{Q}$ such that $|a_k - b_k| < \frac{\varepsilon}{n+1}$. Then if we let

$$q(x) := \sum_{k=0}^n b_k x^k,$$

we have

$$|p(x) - q(x)| = \left| \sum_{k=0}^n (a_k - b_k) x^k \right| \leq \sum_{k=0}^n |a_k - b_k| x^k \leq \sum_{k=0}^n |a_k - b_k| < \sum_{k=0}^n \frac{\varepsilon}{n+1} = \varepsilon. \quad \square$$

Remark 11.7.3. While we will not prove this, the corollary above implies that $C([a, b], \mathbb{C})$ has the same cardinality as \mathbb{R} , which may be a bit surprising. The set of all functions $[a, b] \rightarrow \mathbb{C}$ has cardinality that is strictly greater than the cardinality of \mathbb{R} , it has the cardinality of the power set of \mathbb{R} . So the set of continuous functions is a very tiny subset of the set of all functions.

Warning! The fact that every continuous function $f: [-1, 1] \rightarrow \mathbb{C}$ (or any interval $[a, b]$) can be uniformly approximated by polynomials

$$\sum_{k=0}^n a_k x^k$$

does not mean that every continuous f is analytic, that is, equal to a power series

$$\sum_{k=0}^{\infty} c_k x^k.$$

An analytic function is infinitely differentiable, so the function $|x|$ provides a counterexample.

The key distinction is that the polynomials coming from the Weierstrass theorem are not the partial sums of a power series. For each one, the coefficients a_k above can be completely different—they do not need to come from a single sequence $\{c_k\}$.

11.7.2 Stone–Weierstrass approximation

We want to abstract away what is not really necessary and prove a general version of the Weierstrass theorem. The polynomials are dense in the space of continuous functions on a compact interval. What other kind of families of functions are also dense? And if the domain is an arbitrary metric space, then we no longer have polynomials to begin with.

The theorem we will prove is the Stone–Weierstrass theorem*. First, we need a very special case of the Weierstrass theorem though.

Corollary 11.7.4. *Let $[-a, a]$ be an interval. Then there is a sequence of real polynomials $\{p_n\}$ that converges uniformly to $|x|$ on $[-a, a]$ and such that $p_n(0) = 0$ for all n .*

Proof. As $f(x) := |x|$ is continuous and real-valued on $[-a, a]$, the Weierstrass theorem gives a sequence of real polynomials $\{\tilde{p}_n\}$ that converges to f uniformly on $[-a, a]$. Let

$$p_n(x) := \tilde{p}_n(x) - \tilde{p}_n(0).$$

Obviously $p_n(0) = 0$.

Given $\varepsilon > 0$, let N be such that for $n \geq N$, we have $|\tilde{p}_n(x) - |x|| < \varepsilon/2$ for all $x \in [-a, a]$. In particular, $|\tilde{p}_n(0)| < \varepsilon/2$. Then for $n \geq N$,

$$|p_n(x) - |x|| = |\tilde{p}_n(x) - \tilde{p}_n(0) - |x|| \leq |\tilde{p}_n(x) - |x|| + |\tilde{p}_n(0)| < \varepsilon/2 + \varepsilon/2 = \varepsilon. \quad \square$$

Following the proof of the corollary, we can always make the polynomials from the Weierstrass theorem have a fixed value at one point, so it works not just for $|x|$, but that's the one we will need.

Definition 11.7.5. A set \mathcal{A} of complex-valued functions $f: X \rightarrow \mathbb{C}$ is said to be an *algebra* (sometimes *complex algebra* or *algebra over \mathbb{C}*) if for all $f, g \in \mathcal{A}$ and $c \in \mathbb{C}$, we have

- (i) $f + g \in \mathcal{A}$.
- (ii) $fg \in \mathcal{A}$.
- (iii) $cg \in \mathcal{A}$.

A *real algebra* or an *algebra over \mathbb{R}* is a set of real-valued functions that satisfies the three properties above for $c \in \mathbb{R}$.

We are interested in the case when X is a compact metric space. Then $C(X, \mathbb{C})$ and $C(X, \mathbb{R})$ are metric spaces. Given a set $\mathcal{A} \subset C(X, \mathbb{C})$, the set of all uniform limits is the metric space closure $\overline{\mathcal{A}}$. When we talk about closure of an algebra from now on we mean the closure in $C(X, \mathbb{C})$ as a metric space. Same for $C(X, \mathbb{R})$.

The set \mathcal{P} of all polynomials is an algebra in $C([a, b], \mathbb{C})$, and we have shown that its closure $\overline{\mathcal{P}} = C([a, b], \mathbb{C})$. That is, it is dense. That is the sort of result that we wish to prove.

We leave the following proposition as an exercise.

Proposition 11.7.6. *Suppose X is a compact metric space. If $\mathcal{A} \subset C(X, \mathbb{C})$ is an algebra, then the closure $\overline{\mathcal{A}}$ is also an algebra. Similarly for a real algebra in $C(X, \mathbb{R})$.*

*Named after the American mathematician [Marshall Harvey Stone](#) (1903–1989), and the German mathematician [Karl Theodor Wilhelm Weierstrass](#) (1815–1897).

Let us distill the properties of polynomials that were sufficient for an approximation theorem.

Definition 11.7.7. Let \mathcal{A} be a set of complex-valued functions defined on a set X .

- (i) \mathcal{A} *separates points* if for every $x, y \in X$, with $x \neq y$ there is a function $f \in \mathcal{A}$ such that $f(x) \neq f(y)$.
- (ii) \mathcal{A} *vanishes at no point* if for every $x \in X$ there is an $f \in \mathcal{A}$ such that $f(x) \neq 0$.

Example 11.7.8: The set \mathcal{P} of polynomials separates points and vanishes at no point on \mathbb{R} . That is, $1 \in \mathcal{P}$ so it vanishes at no point. And for $x, y \in \mathbb{R}$, $x \neq y$, take $f(t) := t$: $f(x) = x \neq y = f(y)$. So \mathcal{P} separates points.

Example 11.7.9: The set of functions of the form

$$f(t) = a_0 + \sum_{n=1}^k a_n \cos(nt)$$

is an algebra, which follows by the identity $\cos(mt)\cos(nt) = \frac{\cos((n+m)t)}{2} + \frac{\cos((n-m)t)}{2}$. The algebra does not separate points if the domain is an interval of the form $[-a, a]$, because $f(-t) = f(t)$ for all t . It does separate points if the domain is $[0, \pi]$, as $\cos(t)$ is one-to-one on that set.

Example 11.7.10: The set of polynomials with no constant term vanishes at the origin.

Proposition 11.7.11. Suppose \mathcal{A} is an algebra of complex-valued functions on a set X , that separates points and vanishes at no point. Suppose x, y are distinct points of X , and $c, d \in \mathbb{C}$. Then there is an $f \in \mathcal{A}$ such that

$$f(x) = c, \quad f(y) = d.$$

If \mathcal{A} is a real algebra, the conclusion holds for $c, d \in \mathbb{R}$.

Proof. There must exist an $g, h, k \in \mathcal{A}$ such that

$$g(x) \neq g(y), \quad h(x) \neq 0, \quad k(y) \neq 0.$$

Let

$$f := c \frac{(g - g(y))h}{(g(x) - g(y))h(x)} + d \frac{(g - g(x))k}{(g(y) - g(x))k(y)} = c \frac{gh - g(y)h}{g(x)h(x) - g(y)h(x)} + d \frac{gk - g(x)k}{g(y)k(y) - g(x)k(y)}.$$

Do note that we are not dividing by zero (clear from the first formula). Also from the first formula we see that $f(x) = c$ and $f(y) = d$. By the second formula we see that $f \in \mathcal{A}$ (as \mathcal{A} is an algebra). \square

Theorem 11.7.12 (Stone–Weierstrass, real version). *Let X be a compact metric space and \mathcal{A} an algebra of real-valued continuous functions on X , such that \mathcal{A} separates points and vanishes at no point. Then the closure $\overline{\mathcal{A}} = C(X, \mathbb{R})$.*

The proof is divided into several claims.

Claim 1: If $f \in \overline{\mathcal{A}}$, then $|f| \in \overline{\mathcal{A}}$.

Proof. The function f is bounded (continuous on a compact set), so there is an M such that $|f(x)| \leq M$ for all $x \in X$.

Let $\varepsilon > 0$ be given. By the corollary to the Weierstrass theorem there exists a real polynomial $c_1y + c_2y^2 + \cdots + c_Ny^N$ (vanishing at $y = 0$) such that

$$\left| |y| - \sum_{j=1}^N c_j y^j \right| < \varepsilon$$

for all $y \in [-M, M]$. Because $\overline{\mathcal{A}}$ is an algebra and because there is no constant term in the polynomial,

$$\sum_{j=1}^N c_j f^j \in \overline{\mathcal{A}}.$$

As $|f(x)| \leq M$, then for all $x \in X$

$$\left| |f(x)| - \sum_{j=1}^N c_j (f(x))^j \right| < \varepsilon.$$

So $|f|$ is in the closure of $\overline{\mathcal{A}}$, which is closed. In other words, $|f| \in \overline{\mathcal{A}}$. □

Claim 2: If $f \in \overline{\mathcal{A}}$ and $g \in \overline{\mathcal{A}}$, then $\max(f, g) \in \overline{\mathcal{A}}$ and $\min(f, g) \in \overline{\mathcal{A}}$, where

$$(\max(f, g))(x) := \max\{f(x), g(x)\}, \quad \text{and} \quad (\min(f, g))(x) := \min\{f(x), g(x)\}.$$

Proof. Write:

$$\max(f, g) = \frac{f+g}{2} + \frac{|f-g|}{2},$$

and

$$\min(f, g) = \frac{f+g}{2} - \frac{|f-g|}{2}.$$

As $\overline{\mathcal{A}}$ is an algebra we are done. □

The claim is true for the minimum or maximum of every finite collection of functions as well.

Claim 3: Given $f \in C(X, \mathbb{R})$, $x \in X$ and $\varepsilon > 0$ there exists a $g_x \in \overline{\mathcal{A}}$ with $g_x(x) = f(x)$ and

$$g_x(t) > f(t) - \varepsilon \quad \text{for all } t \in X.$$

Proof. Fix f , x , and ε . By [Proposition 11.7.11](#), for every $y \in X$ we find an $h_y \in \mathcal{A}$ such that

$$h_y(x) = f(x), \quad h_y(y) = f(y).$$

As h_y and f are continuous, the function $h_y - f$ is continuous, and the set

$$U_y := \{t \in X : h_y(t) > f(t) - \varepsilon\} = (h_y - f)^{-1}((-\varepsilon, \infty))$$

is open (it is the inverse image of an open set by a continuous function). Furthermore $y \in U_y$. So the sets U_y cover X .

The space X is compact so there exist finitely many points y_1, y_2, \dots, y_n in X such that

$$X = \bigcup_{j=1}^n U_{y_j}.$$

Let

$$g_x := \max(h_{y_1}, h_{y_2}, \dots, h_{y_n}).$$

By Claim 2, $g_x \in \overline{\mathcal{A}}$. Furthermore,

$$g_x(t) > f(t) - \varepsilon$$

for all $t \in X$, since for every t , there is a y_j such that $t \in U_{y_j}$, and so $h_{y_j}(t) > f(t) - \varepsilon$.

Finally $h_y(x) = f(x)$ for all $y \in X$, so $g_x(x) = f(x)$. □

Claim 4: If $f \in C(X, \mathbb{R})$ and $\varepsilon > 0$ is given, then there exists an $\varphi \in \overline{\mathcal{A}}$ such that

$$|f(x) - \varphi(x)| < \varepsilon.$$

Proof. For every x find the function g_x as in Claim 3.

Let

$$V_x := \{t \in X : g_x(t) < f(t) + \varepsilon\}.$$

The sets V_x are open as g_x and f are continuous. As $g_x(x) = f(x)$, then $x \in V_x$. So the sets V_x cover X . By compactness of X , there are finitely many points x_1, x_2, \dots, x_k such that

$$X = \bigcup_{j=1}^k V_{x_j}.$$

Let

$$\varphi := \min(g_{x_1}, g_{x_2}, \dots, g_{x_k}).$$

By Claim 2, $\varphi \in \overline{\mathcal{A}}$. Similarly as before (same argument as in Claim 3), for all $t \in X$,

$$\varphi(t) < f(t) + \varepsilon.$$

Since all the g_x satisfy $g_x(t) > f(t) - \varepsilon$ for all $t \in X$, $\varphi(t) > f(t) - \varepsilon$ as well. Therefore, for all t ,

$$-\varepsilon < \varphi(t) - f(t) < \varepsilon,$$

which is the desired conclusion. □

The proof of the theorem follows from Claim 4. The claim states that an arbitrary continuous function is in the closure of $\overline{\mathcal{A}}$, which itself is closed. So the theorem is proved.

Example 11.7.13: The functions of the form

$$f(t) = \sum_{j=1}^n c_j e^{jt},$$

for $c_j \in \mathbb{R}$, are dense in $C([a, b], \mathbb{R})$. We need to note that such functions are a real algebra, which follows from $e^{jt} e^{kt} = e^{(j+k)t}$. They separate points as e^t is one-to-one, and $e^t > 0$ for all t so the algebra does not vanish at any point.

In general if we have a set of functions that separates points and does not vanish at any point, we can let these functions *generate* an algebra by considering all the linear combinations of arbitrary multiples of such functions. That is, we consider all real polynomials without constant term of such functions. In the example above, the algebra is generated by e^t . We consider polynomials in e^t without constant term.

Example 11.7.14: We mentioned that the set of all functions of the form

$$a_0 + \sum_{n=1}^N a_n \cos(nt)$$

is an algebra. When considered on $[0, \pi]$, it separates points and vanishes nowhere so [Stone–Weierstrass](#) applies. As for polynomials, you *do not* want to conclude that every continuous function on $[0, \pi]$ has a uniformly convergent Fourier cosine series, that is, that every continuous function can be written as

$$a_0 + \sum_{n=1}^{\infty} a_n \cos(nt).$$

That is *not true!* There exist continuous functions whose Fourier series does not converge even pointwise let alone uniformly.

To obtain Stone–Weierstrass for complex algebras, we must make an extra assumption.

Definition 11.7.15. An algebra \mathcal{A} is *self-adjoint* if for all $f \in \mathcal{A}$, the function \bar{f} defined by $\bar{f}(x) := \overline{f(x)}$ is in \mathcal{A} , where by the bar we mean the complex conjugate.

Theorem 11.7.16 (Stone–Weierstrass, complex version). *Let X be a compact metric space and \mathcal{A} an algebra of complex-valued continuous functions on X , such that \mathcal{A} separates points, vanishes at no point, and is self-adjoint. Then the closure $\overline{\mathcal{A}} = C(X, \mathbb{C})$.*

Proof. Suppose $\mathcal{A}_{\mathbb{R}} \subset \mathcal{A}$ is the set of the real-valued elements of \mathcal{A} . For $f \in \mathcal{A}$, write $f = u + iv$ where u and v are real-valued. Then

$$u = \frac{f + \bar{f}}{2}, \quad v = \frac{f - \bar{f}}{2i}.$$

So $u, v \in \mathcal{A}$ as \mathcal{A} is a self-adjoint algebra, and since they are real-valued $u, v \in \mathcal{A}_{\mathbb{R}}$.

If $x \neq y$, then find an $f \in \mathcal{A}$ such that $f(x) \neq f(y)$. If $f = u + iv$, then it is obvious that either $u(x) \neq u(y)$ or $v(x) \neq v(y)$. So $\mathcal{A}_{\mathbb{R}}$ separates points.

Similarly, for every x find $f \in \mathcal{A}$ such that $f(x) \neq 0$. If $f = u + iv$, then either $u(x) \neq 0$ or $v(x) \neq 0$. So $\mathcal{A}_{\mathbb{R}}$ vanishes at no point.

The set $\mathcal{A}_{\mathbb{R}}$ is a real algebra, and satisfies the hypotheses of the [real Stone–Weierstrass theorem](#). Given any $f = u + iv \in C(X, \mathbb{C})$, we find $g, h \in \mathcal{A}_{\mathbb{R}}$ such that $|u(t) - g(t)| < \varepsilon/2$ and $|v(t) - h(t)| < \varepsilon/2$ for all $t \in X$. Next, $g + ih \in \mathcal{A}$, and

$$\begin{aligned} |f(t) - (g(t) + ih(t))| &= |u(t) + iv(t) - (g(t) + ih(t))| \\ &\leq |u(t) - g(t)| + |v(t) - h(t)| < \varepsilon/2 + \varepsilon/2 = \varepsilon \end{aligned}$$

for all $t \in X$. So $\overline{\mathcal{A}} = C(X, \mathbb{C})$. □

The self-adjoint requirement is necessary although it is not so obvious to see it. For an example see [Exercise 11.7.9](#).

Here is an interesting application. When working with functions of two variables, it may be useful to work with functions of the form $f(x)g(y)$ rather than $F(x,y)$. For example, they are easier to integrate. We have the following.

Example 11.7.17: Any continuous function $F: [0, 1] \times [0, 1] \rightarrow \mathbb{C}$ can be approximated uniformly by functions of the form

$$\sum_{j=1}^n f_j(x)g_j(y),$$

where $f_j: [0, 1] \rightarrow \mathbb{C}$ and $g_j: [0, 1] \rightarrow \mathbb{C}$ are continuous.

Proof: It is not hard to see that the functions of the above form are a complex algebra. It is equally easy to show that they vanish nowhere, separate points, and the algebra is self-adjoint. As $[0, 1] \times [0, 1]$ is compact we apply [Stone–Weierstrass](#) to obtain the result.

11.7.3 Exercises

Exercise 11.7.1: Prove [Proposition 11.7.6](#). Hint: If $\{f_n\}$ is a sequence in $C(X, \mathbb{R})$ converging to f , then as f is bounded, you can show that f_n is uniformly bounded, that is, there exists a single bound for all f_n (and f).

Exercise 11.7.2: Suppose $X := \mathbb{R}$ (not compact in particular). Show that $f(t) := e^t$ is not possible to uniformly approximate by polynomials on X . Hint: Consider $\left| \frac{e^t}{t^n} \right|$ as $t \rightarrow \infty$.

Exercise 11.7.3: Suppose $f: [0, 1] \rightarrow \mathbb{C}$ is a uniform limit of a sequence of polynomials of degree at most d , then the limit is a polynomial of degree at most d . Conclude that to approximate a function which is not a polynomial, we need the degree of the approximations to go to infinity.

Hint: First prove that if a sequence of polynomials of degree d converges uniformly to the zero function, then the coefficients converge to zero. One way to do this is linear algebra: Consider a polynomial p evaluated at $d+1$ points to be a linear operator taking the coefficients of p to the values of p (an operator in $L(\mathbb{R}^{d+1})$).

Exercise 11.7.4: Suppose $f: [0, 1] \rightarrow \mathbb{R}$ is continuous and $\int_0^1 f(x)x^n dx = 0$ for all $n = 0, 1, 2, \dots$. Show that $f(x) = 0$ for all $x \in [0, 1]$. Hint: Approximate by polynomials to show that $\int_0^1 (f(x))^2 dx = 0$.

Exercise 11.7.5: Suppose $I: C([0, 1], \mathbb{R}) \rightarrow \mathbb{R}$ is a linear continuous function such that $I(x^n) = \frac{1}{n+1}$ for all $n = 0, 1, 2, 3, \dots$. Prove that $I(f) = \int_0^1 f$ for all $f \in C([0, 1], \mathbb{R})$.

Exercise 11.7.6: Let \mathcal{A} be the collection of real polynomials in x^2 , that is polynomials of the form $c_0 + c_1x^2 + c_2x^4 + \dots + c_dx^{2d}$.

- Show that every $f \in C([0, 1], \mathbb{R})$ is a uniform limit of polynomials from \mathcal{A} .
- Find an $f \in C([-1, 1], \mathbb{R})$ that is not a uniform limit of polynomials from \mathcal{A} .
- Which hypothesis of the real Stone–Weierstrass is not satisfied for the domain $[-1, 1]$?

Exercise 11.7.7: Let $|z| = 1$ define the unit circle $S^1 \subset \mathbb{C}$.

a) Show that functions of the form

$$\sum_{k=-n}^n c_k z^k$$

are dense in $C(S^1, \mathbb{C})$. Notice the negative powers.

b) Show that functions of the form

$$c_0 + \sum_{k=1}^n c_k z^k + \sum_{k=1}^n c_{-k} \bar{z}^k$$

are dense in $C(S^1, \mathbb{C})$. These are so-called harmonic polynomials, and this approximation leads to, for example, the solution of the steady state heat problem.

Hint: A good way to write the equation for S^1 is $z\bar{z} = 1$.

Exercise 11.7.8: Show that for complex numbers c_j , the set of functions of x on $[-\pi, \pi]$ of the form

$$\sum_{k=-n}^n c_k e^{ikx}$$

satisfies the hypotheses of the complex Stone–Weierstrass theorem and therefore such functions are dense in the $C([-\pi, \pi], \mathbb{C})$.

Exercise 11.7.9: Let $S^1 \subset \mathbb{C}$ be the unit circle, that is the set where $|z| = 1$. Orient this set counterclockwise. Let $\gamma(t) := e^{it}$. For the one-form $f(z) dz$ we write*

$$\int_{S^1} f(z) dz := \int_0^{2\pi} f(e^{it}) ie^{it} dt.$$

a) Prove that for all nonnegative integers $k = 0, 1, 2, 3, \dots$, we have $\int_{S^1} z^k dz = 0$.

b) Prove that if $P(z) = \sum_{k=0}^n c_k \bar{z}^k$ is a polynomial in z , then $\int_{S^1} P(z) dz = 0$.

c) Prove $\int_{S^1} \bar{z} dz \neq 0$.

d) Conclude that polynomials in z (this algebra of functions is not self-adjoint) are not dense in $C(S^1, \mathbb{C})$.

Exercise 11.7.10: Let (X, d) be a compact metric space and suppose $\mathcal{A} \subset C(X, \mathbb{R})$ is a real algebra that separates points, but such that for some x_0 , $f(x_0) = 0$ for all $f \in \mathcal{A}$. Prove that every function $g \in C(X, \mathbb{R})$ such that $g(x_0) = 0$ is a uniform limit of functions from \mathcal{A} .

Exercise 11.7.11: Let (X, d) be a compact metric space and suppose $\mathcal{A} \subset C(X, \mathbb{R})$ is a real algebra. Suppose that for each $y \in X$ the closure $\overline{\mathcal{A}}$ contains the function $\phi_y(x) := d(y, x)$. Then $\overline{\mathcal{A}} = C(X, \mathbb{R})$.

Exercise 11.7.12:

a) Suppose $f: [a, b] \rightarrow \mathbb{C}$ is continuously differentiable. Show that there exists a sequence of polynomials $\{p_n\}$ that converges in the C^1 norm to f , that is $\|f - p_n\|_u + \|f' - p_n'\|_u \rightarrow 0$ as $n \rightarrow \infty$.

b) Suppose $f: [a, b] \rightarrow \mathbb{C}$ is k times continuously differentiable. Show that there exists a sequence of polynomials $\{p_n\}$ that converges in the C^k norm to f , that is

$$\sum_{j=0}^k \|f^{(j)} - p_n^{(j)}\|_u \rightarrow 0 \quad \text{as} \quad n \rightarrow \infty.$$

*One could also define $dz := dx + i dy$ and then extend the path integral from [chapter 9](#) to complex-valued one-forms.

Exercise 11.7.13:

- a) Show that an even function $f: [-1, 1] \rightarrow \mathbb{R}$ is a uniform limit of polynomials with even powers only, that is, polynomials of the form $a_0 + a_1x^2 + a_2x^4 + \cdots + a_kx^{2k}$.
- b) Show that an odd function $f: [-1, 1] \rightarrow \mathbb{R}$ is a uniform limit of polynomials with odd powers only, that is, polynomials of the form $b_1x + b_2x^3 + b_3x^5 + \cdots + b_kx^{2k-1}$.

11.8 Fourier series

Note: 3–4 lectures

Fourier series* is perhaps the most important (and most difficult to understand) of the series that we cover in this book. We have seen it in a few examples before, but let us start at the beginning.

11.8.1 Trigonometric polynomials

A *trigonometric polynomial* is an expression of the form

$$a_0 + \sum_{n=1}^N (a_n \cos(nx) + b_n \sin(nx)),$$

or equivalently, thanks to Euler's formula ($e^{i\theta} = \cos(\theta) + i \sin(\theta)$):

$$\sum_{n=-N}^N c_n e^{inx}.$$

The second form is usually more convenient. If $|z| = 1$ we write $z = e^{ix}$, and so

$$\sum_{n=-N}^N c_n e^{inx} = \sum_{n=-N}^N c_n z^n.$$

So a trigonometric polynomial is really a rational function (we are allowing negative powers) evaluated on the unit circle. There is a wonderful connection between power series (actually Laurent series because of the negative powers) and Fourier series because of this observation, but we will not investigate this further.

Another reason why Fourier series are important and come up in so many applications is that the functions are eigenfunctions† of various differential operators. For example,

$$\frac{d}{dx} [e^{ikx}] = (ik)e^{ikx}, \quad \frac{d^2}{dx^2} [e^{ikx}] = (-k^2)e^{ikx}.$$

That is, they are the functions whose derivative is a scalar (the eigenvalue) times itself. Just as eigenvalues and eigenvectors are important in studying matrices, eigenvalues and eigenfunctions are important when studying linear differential equations.

The functions $\cos(nx)$, $\sin(nx)$, and e^{inx} are 2π -periodic and hence trigonometric polynomials are also 2π -periodic. We could rescale x to make the period different, but the theory is the same, so let us stick with the period of 2π . The antiderivative of e^{inx} is $\frac{e^{inx}}{in}$ and so

$$\int_{-\pi}^{\pi} e^{inx} dx = \begin{cases} 2\pi & \text{if } n = 0, \\ 0 & \text{otherwise.} \end{cases}$$

*Named after the French mathematician [Jean-Baptiste Joseph Fourier](#) (1768–1830).

†Eigenfunction is like an eigenvector for a matrix, but for a linear operator on a vector space of functions.

Consider

$$f(x) := \sum_{n=-N}^N c_n e^{inx},$$

and for $m = -N, \dots, N$ compute

$$\frac{1}{2\pi} \int_{-\pi}^{\pi} f(x) e^{-imx} dx = \frac{1}{2\pi} \int_{-\pi}^{\pi} \left(\sum_{n=-N}^N c_n e^{i(n-m)x} \right) dx = \sum_{n=-N}^N c_n \frac{1}{2\pi} \int_{-\pi}^{\pi} e^{i(n-m)x} dx = c_m.$$

We just found a way of computing the coefficients c_m using an integral of f . If $|m| > N$, the integral is just 0: We might as well have included enough zero coefficients to make $|m| \leq N$.

Proposition 11.8.1. *A trigonometric polynomial $f(x) = \sum_{n=-N}^N c_n e^{inx}$ is real-valued for real x if and only if $c_{-m} = \overline{c_m}$ for all $m = -N, \dots, N$.*

Proof. If $f(x)$ is real-valued, that is $\overline{f(x)} = f(x)$, then

$$\overline{c_m} = \overline{\frac{1}{2\pi} \int_{-\pi}^{\pi} f(x) e^{-imx} dx} = \frac{1}{2\pi} \int_{-\pi}^{\pi} \overline{f(x) e^{-imx}} dx = \frac{1}{2\pi} \int_{-\pi}^{\pi} f(x) e^{imx} dx = c_{-m}.$$

The complex conjugate goes inside the integral because the integral is done on real and imaginary parts separately.

On the other hand if $c_{-m} = \overline{c_m}$, then

$$\overline{c_{-m} e^{-imx} + c_m e^{imx}} = \overline{c_{-m}} e^{imx} + \overline{c_m} e^{-imx} = c_m e^{imx} + c_{-m} e^{-imx},$$

which is real valued. Also $c_0 = \overline{c_0}$, so c_0 is real. By pairing up the terms we obtain that f has to be real-valued. \square

The functions e^{inx} are also linearly independent.

Proposition 11.8.2. *If*

$$\sum_{n=-N}^N c_n e^{inx} = 0$$

for all $x \in [-\pi, \pi]$, then $c_n = 0$ for all n .

Proof. The result follows immediately from the integral formula for c_n . \square

11.8.2 Fourier series

We now take limits. We call the series

$$\sum_{n=-\infty}^{\infty} c_n e^{inx}$$

the *Fourier series*. The numbers c_n are called *Fourier coefficients*. Using Euler's formula $e^{i\theta} = \cos(\theta) + i \sin(\theta)$, we could also develop everything with sines and cosines, that is, as the series $a_0 + \sum_{n=1}^{\infty} a_n \cos(nx) + b_n \sin(nx)$, but it is equivalent and slightly more messy.

Several questions arise. What functions are expressible as Fourier series? Obviously, they have to be 2π -periodic, but not every periodic function is expressible with the series. Furthermore, if we do have a Fourier series, where does it converge (where and if at all)? Does it converge absolutely? Uniformly? Also note that the series has two limits. When talking about Fourier series convergence, we often talk about the following limit:

$$\lim_{N \rightarrow \infty} \sum_{n=-N}^N c_n e^{inx}.$$

There are other ways we can sum the series that can get convergence in more situations, but we refrain from discussing those.

Conversely, we start with an integrable function $f: [-\pi, \pi] \rightarrow \mathbb{C}$, and we call the numbers

$$c_n := \frac{1}{2\pi} \int_{-\pi}^{\pi} f(x) e^{-inx} dx$$

its *Fourier coefficients*. Often these numbers are written as $\hat{f}(n)$.^{*} We then formally write down a Fourier series. As you might imagine such a series might not even converge. We write

$$f(x) \sim \sum_{n=-\infty}^{\infty} c_n e^{inx},$$

although the \sim doesn't imply anything about the two sides being equal in any way. It is simply that we created a formal series using the formula for the coefficients.

A few sections ago, we proved that the Fourier series

$$\sum_{n=1}^{\infty} \frac{\sin(nx)}{n^2}$$

converges uniformly and hence converges to a continuous function. This example and its proof can be extended to a more general criterion.

Proposition 11.8.3. *Let $\sum_{n=-\infty}^{\infty} c_n e^{inx}$ be a Fourier series, and $C, \alpha > 1$ constants such that*

$$|c_n| \leq \frac{C}{|n|^\alpha} \quad \text{for all } n \in \mathbb{Z} \setminus \{0\}.$$

Then the series converges (absolutely and uniformly) to a continuous function on \mathbb{R} .

The proof is to apply the Weierstrass M -test ([Theorem 11.2.4](#)) and the p -series test, to find that the series converges uniformly and hence to a continuous function. We can also take derivatives.

Proposition 11.8.4. *Let $\sum_{n=-\infty}^{\infty} c_n e^{inx}$ be a Fourier series, and $C, \alpha > 2$ constants such that*

$$|c_n| \leq \frac{C}{|n|^\alpha} \quad \text{for all } n \in \mathbb{Z} \setminus \{0\}.$$

Then the series converges to a continuously differentiable function on \mathbb{R} .

^{*}The notation seems similar to Fourier transform for those readers that have seen it. The similarity is not just coincidental, we are taking a type of Fourier transform here.

The trick is to first notice that the series converges first to a continuous function by the previous proposition, so in particular it converges at some point. Then differentiate the partial sums

$$\sum_{n=-N}^N inc_n e^{inx}$$

and notice that

$$|inc_n| \leq \frac{C}{|n|^{\alpha-1}}.$$

The differentiated series converges uniformly by the M -test again. Since the differentiated series converges uniformly, we find that the original series $\sum c_n e^{inx}$ converges to a continuously differentiable function, whose derivative is the differentiated series.

By iterating the same reasoning we find that if for some C and $\alpha > k + 1$ ($k \in \mathbb{N}$), we have

$$|c_n| \leq \frac{C}{|n|^\alpha}$$

for all nonzero integers n , then the Fourier series converges to a k -times continuously differentiable function. Therefore, the faster the coefficients go to zero, the more regular the limit is.

11.8.3 Orthonormal systems

Let us abstract away some of the properties of the exponentials, and study a more general series for a function. One fundamental property of the exponentials that make Fourier series what it is that the exponentials are a so-called *orthonormal system*. Let us fix an interval $[a, b]$. We define an *inner product* for the space of functions. We restrict our attention to Riemann integrable functions since we do not have the Lebesgue integral, which would be the natural choice. Let f and g be complex-valued Riemann integrable functions on $[a, b]$ and define the inner product

$$\langle f, g \rangle := \int_a^b f(x) \overline{g(x)} dx.$$

If you have seen Hermitian inner products in linear algebra, this is precisely such a product. We have to put in the conjugate as we are working with complex numbers. We then have the “size,” that is the L^2 norm $\|f\|_2$ by (defining the square)

$$\|f\|_2^2 := \langle f, f \rangle = \int_a^b |f(x)|^2 dx.$$

Remark 11.8.5. Notice the similarity to finite dimensions. For $z = (z_1, z_2, \dots, z_n) \in \mathbb{C}^n$ we define

$$\langle z, w \rangle := \sum_{k=1}^n z_k \overline{w_k}$$

and then the norm is (usually it is denoted by simply $\|z\|$ rather than $\|z\|_2$)

$$\|z\|^2 = \langle z, z \rangle = \sum_{k=1}^n |z_k|^2.$$

This is just the euclidean distance to the origin in \mathbb{C}^n (same as \mathbb{R}^{2n}).

Let us get back to function spaces. In what follows, we will assume all functions are Riemann integrable.

Definition 11.8.6. Let $\{\varphi_n\}$ be a sequence of integrable complex-valued functions on $[a, b]$. We say that this is an *orthonormal system* if

$$\langle \varphi_n, \varphi_m \rangle = \int_a^b \varphi_n(x) \overline{\varphi_m(x)} dx = \begin{cases} 1 & \text{if } n = m, \\ 0 & \text{otherwise.} \end{cases}$$

In particular, $\|\varphi_n\|_2 = 1$ for all n . If we only require that $\langle \varphi_n, \varphi_m \rangle = 0$ for $m \neq n$, then the system would be called an *orthogonal system*.

We noticed above that

$$\left\{ \frac{1}{\sqrt{2\pi}} e^{inx} \right\}$$

is an orthonormal system. The factor out in front is to make the norm be 1.

Having an orthonormal system $\{\varphi_n\}$ on $[a, b]$ and an integrable function f on $[a, b]$, we can write a Fourier series relative to $\{\varphi_n\}$. We let

$$c_n := \langle f, \varphi_n \rangle = \int_a^b f(x) \overline{\varphi_n(x)} dx,$$

and write

$$f(x) \sim \sum_{n=1}^{\infty} c_n \varphi_n.$$

In other words, the series is

$$\sum_{n=1}^{\infty} \langle f, \varphi_n \rangle \varphi_n(x).$$

Notice the similarity to the expression for the orthogonal projection of a vector onto a subspace from linear algebra. We are in fact doing just that, but in a space of functions.

Theorem 11.8.7. Suppose f is a Riemann integrable function on $[a, b]$. Let $\{\varphi_n\}$ be an orthonormal system on $[a, b]$ and suppose

$$f(x) \sim \sum_{n=1}^{\infty} c_n \varphi_n(x).$$

If

$$s_n(x) := \sum_{k=1}^n c_k \varphi_k(x) \quad \text{and} \quad p_n(x) := \sum_{k=1}^n d_k \varphi_k(x)$$

for some other sequence $\{d_k\}$, then

$$\int_a^b |f(x) - s_n(x)|^2 dx = \|f - s_n\|_2^2 \leq \|f - p_n\|_2^2 = \int_a^b |f(x) - p_n(x)|^2 dx$$

with equality only if $d_k = c_k$ for all $k = 1, 2, \dots, n$.

In other words, the partial sums of the Fourier series are the best approximation with respect to the L^2 norm.

Proof. Let us write

$$\int_a^b |f - p_n|^2 = \int_a^b |f|^2 - \int_a^b f \bar{p}_n - \int_a^b \bar{f} p_n + \int_a^b |p_n|^2.$$

Now

$$\int_a^b f \bar{p}_n = \int_a^b f \sum_{k=1}^n \bar{d}_k \bar{\varphi}_k = \sum_{k=1}^n \bar{d}_k \int_a^b f \bar{\varphi}_k = \sum_{k=1}^n \bar{d}_k c_k,$$

and

$$\int_a^b |p_n|^2 = \int_a^b \sum_{k=1}^n d_k \varphi_k \sum_{j=1}^n \bar{d}_j \bar{\varphi}_j = \sum_{k=1}^n \sum_{j=1}^n d_k \bar{d}_j \int_a^b \varphi_k \bar{\varphi}_j = \sum_{k=1}^n |d_k|^2.$$

So

$$\int_a^b |f - p_n|^2 = \int_a^b |f|^2 - \sum_{k=1}^n \bar{d}_k c_k - \sum_{k=1}^n d_k \bar{c}_k + \sum_{k=1}^n |d_k|^2 = \int_a^b |f|^2 - \sum_{k=1}^n |c_k|^2 + \sum_{k=1}^n |d_k - c_k|^2.$$

This is minimized precisely when $d_k = c_k$. □

When we do plug in $d_k = c_k$, then

$$\int_a^b |f - s_n|^2 = \int_a^b |f|^2 - \sum_{k=1}^n |c_k|^2$$

and so

$$\sum_{k=1}^n |c_k|^2 \leq \int_a^b |f|^2$$

for all n . Note that

$$\sum_{k=1}^n |c_k|^2 = \|s_n\|_2^2$$

by the calculation above. We take a limit to obtain the so-called *Bessel's inequality*.

Theorem 11.8.8 (Bessel's inequality*). *Suppose f is a Riemann integrable function on $[a, b]$. Let $\{\varphi_n\}$ be an orthonormal system on $[a, b]$ and suppose*

$$f(x) \sim \sum_{n=1}^{\infty} c_n \varphi_n(x).$$

Then

$$\sum_{k=1}^{\infty} |c_k|^2 \leq \int_a^b |f|^2 = \|f\|_2^2.$$

In particular (given that a Riemann integrable function satisfies $\int_a^b |f|^2 < \infty$), we get that the series converges and hence

$$\lim_{k \rightarrow \infty} c_k = 0.$$

*Named after the German astronomer, mathematician, physicist, and geodesist [Friedrich Wilhelm Bessel](#) (1784–1846).

11.8.4 The Dirichlet kernel and approximate delta functions

Let us return to the trigonometric Fourier series. Here we note that the system $\{e^{inx}\}$ is orthogonal, but not orthonormal if we simply integrate over $[-\pi, \pi]$. We can also rescale the integral and hence the inner product to make $\{e^{inx}\}$ orthonormal. That is, if we replace

$$\int_a^b \quad \text{with} \quad \frac{1}{2\pi} \int_{-\pi}^{\pi},$$

(we are just rescaling the dx really)*, then everything works and we obtain that the system $\{e^{inx}\}$ is orthonormal with respect to the inner product

$$\langle f, g \rangle = \frac{1}{2\pi} \int_{-\pi}^{\pi} f(x) \overline{g(x)} dx.$$

Suppose $f: \mathbb{R} \rightarrow \mathbb{C}$ is 2π -periodic and integrable on $[-\pi, \pi]$. Let

$$c_n := \frac{1}{2\pi} \int_{-\pi}^{\pi} f(x) e^{-inx} dx.$$

Write

$$f(x) \sim \sum_{n=-\infty}^{\infty} c_n e^{inx}.$$

Define the *symmetric partial sums*

$$s_N(f; x) := \sum_{n=-N}^N c_n e^{inx}.$$

The inequality leading up to Bessel now reads:

$$\frac{1}{2\pi} \int_{-\pi}^{\pi} |s_N(f; x)|^2 dx = \sum_{n=-N}^N |c_n|^2 \leq \frac{1}{2\pi} \int_{-\pi}^{\pi} |f(x)|^2 dx.$$

The *Dirichlet kernel* is the sum

$$D_N(x) := \sum_{n=-N}^N e^{inx}.$$

We claim that

$$D_N(x) = \sum_{n=-N}^N e^{inx} = \frac{\sin((N+1/2)x)}{\sin(x/2)},$$

at least for x such that $\sin(x/2) \neq 0$. We know that the left-hand side is continuous and hence the right-hand side extends continuously to all of \mathbb{R} as well. To show the claim we use a familiar trick:

$$(e^{ix} - 1)D_N(x) = e^{i(N+1)x} - e^{-iNx}.$$

*Mathematicians in this field sometimes simplify matters by making a tongue-in-cheek definition that $1 = 2\pi$.

Multiply by $e^{-ix/2}$

$$(e^{ix/2} - e^{-ix/2})D_N(x) = e^{i(N+1/2)x} - e^{-i(N+1/2)x}.$$

The claim follows.

We expand the definition of s_N

$$\begin{aligned} s_N(f; x) &= \sum_{n=-N}^N \frac{1}{2\pi} \int_{-\pi}^{\pi} f(t) e^{-int} dt e^{inx} \\ &= \frac{1}{2\pi} \int_{-\pi}^{\pi} f(t) \sum_{n=-N}^N e^{in(x-t)} dt = \frac{1}{2\pi} \int_{-\pi}^{\pi} f(t) D_N(x-t) dt. \end{aligned}$$

Convolution strikes again! As D_N and f are 2π -periodic we may also change variables and write

$$s_N(f; x) = \frac{1}{2\pi} \int_{x-\pi}^{x+\pi} f(x-t) D_N(t) dt = \frac{1}{2\pi} \int_{-\pi}^{\pi} f(x-t) D_N(t) dt.$$

See [Figure 11.10](#) for a plot of D_N for $N = 5$ and $N = 20$.

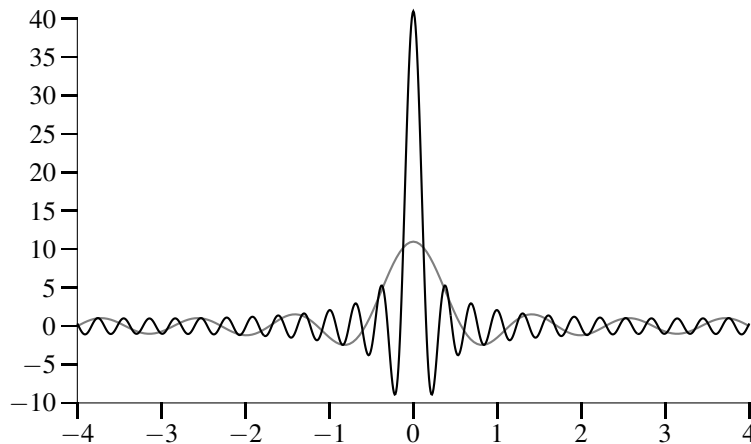

Figure 11.10: Plot of $D_N(x)$ for $N = 5$ (gray) and $N = 20$ (black).

The central peak gets taller and taller as N gets larger, and the side peaks stay small. We are convolving (again) with approximate delta functions, although these functions have all these oscillations away from zero. The oscillations on the side do not go away but they are eventually so fast that we expect the integral to just sort of cancel itself out there. Overall, we expect that $s_N(f)$ goes to f . Things are not always simple, but under some conditions on f , such a conclusion holds. For this reason people write

$$\delta(x) \sim \sum_{n=-\infty}^{\infty} e^{inx}$$

although we have not really defined the delta function (and it is not a function), nor a Fourier series of whatever kind of object it is.

11.8.5 Localization

If f satisfies a Lipschitz condition at a point, then the Fourier series converges at that point.

Theorem 11.8.9. *Let x be fixed and let f be a 2π -periodic function Riemann integrable on $[-\pi, \pi]$. Suppose there exist $\delta > 0$ and M such that*

$$|f(x+t) - f(x)| \leq M|t|$$

for all $t \in (-\delta, \delta)$, then

$$\lim_{N \rightarrow \infty} s_N(f; x) = f(x).$$

In particular, if f is continuously differentiable at x , then we obtain convergence (exercise). We state an often used version of this corollary. A function $f: [a, b] \rightarrow \mathbb{C}$ is *continuous piecewise smooth* if it is continuous and there exist points $x_0 = a < x_1 < x_2 < \cdots < x_k = b$ such that f restricted to $[x_j, x_{j+1}]$ is continuously differentiable (up to the endpoints) for all j .

Corollary 11.8.10. *Let f be a 2π -periodic function Riemann integrable on $[-\pi, \pi]$. Suppose there exist $x \in \mathbb{R}$ and $\delta > 0$ such that f is continuous piecewise smooth on $[x - \delta, x + \delta]$, then*

$$\lim_{N \rightarrow \infty} s_N(f; x) = f(x).$$

The proof of the corollary is left as an exercise. Let us prove the theorem.

Proof of Theorem 11.8.9. For all N ,

$$\frac{1}{2\pi} \int_{-\pi}^{\pi} D_N = 1.$$

Write

$$\begin{aligned} s_N(f; x) - f(x) &= \frac{1}{2\pi} \int_{-\pi}^{\pi} f(x-t) D_N(t) dt - f(x) \frac{1}{2\pi} \int_{-\pi}^{\pi} D_N(t) dt \\ &= \frac{1}{2\pi} \int_{-\pi}^{\pi} (f(x-t) - f(x)) D_N(t) dt \\ &= \frac{1}{2\pi} \int_{-\pi}^{\pi} \frac{f(x-t) - f(x)}{\sin(t/2)} \sin((N+1/2)t) dt. \end{aligned}$$

By the hypotheses, for small nonzero t we get

$$\left| \frac{f(x-t) - f(x)}{\sin(t/2)} \right| \leq \frac{M|t|}{|\sin(t/2)|}.$$

As $\sin(t) = t + h(t)$ where $\frac{h(t)}{t} \rightarrow 0$ as $t \rightarrow 0$, we notice that $\frac{M|t|}{|\sin(t/2)|}$ is continuous at the origin and hence $\frac{f(x-t) - f(x)}{\sin(t/2)}$ must be bounded near the origin. As $t = 0$ is the only place on $[-\pi, \pi]$ where the denominator vanishes, it is the only place where there could be a problem. The function is also Riemann integrable. We use a trigonometric identity

$$\sin((N+1/2)t) = \cos(t/2) \sin(Nt) + \sin(t/2) \cos(Nt),$$

so

$$\begin{aligned} \frac{1}{2\pi} \int_{-\pi}^{\pi} \frac{f(x-t) - f(x)}{\sin(t/2)} \sin((N+1/2)t) dt = \\ \frac{1}{2\pi} \int_{-\pi}^{\pi} \left(\frac{f(x-t) - f(x)}{\sin(t/2)} \cos(t/2) \right) \sin(Nt) dt + \frac{1}{2\pi} \int_{-\pi}^{\pi} (f(x-t) - f(x)) \cos(Nt) dt. \end{aligned}$$

Now $\frac{f(x-t)-f(x)}{\sin(t/2)} \cos(t/2)$ and $(f(x-t) - f(x))$ are bounded Riemann integrable functions and so their Fourier coefficients go to zero by [Theorem 11.8.8](#). So the two integrals on the right-hand side, which compute the Fourier coefficients for the real version of the Fourier series go to 0 as N goes to infinity. This is because $\sin(Nt)$ and $\cos(Nt)$ are also orthonormal systems with respect to the same inner product. Hence $s_N(f;x) - f(x)$ goes to 0, that is, $s_N(f;x)$ goes to $f(x)$. \square

The theorem also says that convergence depends only on local behavior.

Corollary 11.8.11. *Suppose f is a 2π -periodic function, Riemann integrable on $[-\pi, \pi]$. If J is an open interval and $f(x) = 0$ for all $x \in J$, then $\lim s_N(f;x) = 0$ for all $x \in J$.*

In particular, if f and g are 2π -periodic functions, Riemann integrable on $[-\pi, \pi]$, J an open interval, and $f(x) = g(x)$ for all $x \in J$, then for all $x \in J$, the sequence $\{s_N(f;x)\}$ converges if and only if $\{s_N(g;x)\}$ converges.

That is, convergence at x is only dependent on the values of the function near x . To prove the first claim, take $M = 0$ in the theorem. The ‘‘In particular’’ follows by considering the function $f - g$, which is zero on J and $s_N(f - g) = s_N(f) - s_N(g)$. On the other hand, we have seen that the rate of convergence, that is how fast does $s_N(f)$ converge to f , depends on global behavior of the function.

There is a subtle difference between the corollary and what can be achieved by the [Stone–Weierstrass theorem](#). Any continuous function on $[-\pi, \pi]$ can be uniformly approximated by trigonometric polynomials, but these trigonometric polynomials need not be the partial sums s_N .

11.8.6 Parseval’s theorem

Finally, convergence always happens in the L^2 sense and operations on the (infinite) vectors of Fourier coefficients are the same as the operations using the integral inner product.

Theorem 11.8.12 (Parseval*). *Let f and g be 2π -periodic functions, Riemann integrable on $[-\pi, \pi]$ with*

$$f(x) \sim \sum_{n=-\infty}^{\infty} c_n e^{inx} \quad \text{and} \quad g(x) \sim \sum_{n=-\infty}^{\infty} d_n e^{inx}.$$

Then

$$\lim_{N \rightarrow \infty} \|f - s_N(f)\|_2^2 = \lim_{N \rightarrow \infty} \frac{1}{2\pi} \int_{-\pi}^{\pi} |f(x) - s_N(f;x)|^2 dx = 0.$$

Also

$$\langle f, g \rangle = \frac{1}{2\pi} \int_{-\pi}^{\pi} f(x) \overline{g(x)} dx = \sum_{n=-\infty}^{\infty} c_n \overline{d_n},$$

and

$$\|f\|_2^2 = \frac{1}{2\pi} \int_{-\pi}^{\pi} |f(x)|^2 dx = \sum_{n=-\infty}^{\infty} |c_n|^2.$$

*Named after the French mathematician [Marc-Antoine Parseval](#) (1755–1836).

Proof. There exists (exercise) a continuous 2π -periodic function h such that

$$\|f - h\|_2 < \varepsilon.$$

Via [Stone–Weierstrass](#), approximate h with a trigonometric polynomial uniformly. That is, there is a trigonometric polynomial $P(x)$ such that $|h(x) - P(x)| < \varepsilon$ for all x . Hence

$$\|h - P\|_2 = \sqrt{\frac{1}{2\pi} \int_{-\pi}^{\pi} |h(x) - P(x)|^2 dx} \leq \varepsilon.$$

If P is of degree N_0 , then for all $N \geq N_0$

$$\|h - s_N(h)\|_2 \leq \|h - P\|_2 \leq \varepsilon,$$

as $s_N(h)$ is the best approximation for h in L^2 ([Theorem 11.8.7](#)). By the inequality leading up to Bessel, we have

$$\|s_N(h) - s_N(f)\|_2 = \|s_N(h - f)\|_2 \leq \|h - f\|_2 \leq \varepsilon.$$

The L^2 norm satisfies the triangle inequality (exercise). Thus, for all $N \geq N_0$,

$$\|f - s_N(f)\|_2 \leq \|f - h\|_2 + \|h - s_N(h)\|_2 + \|s_N(h) - s_N(f)\|_2 \leq 3\varepsilon.$$

Hence, the first claim follows.

Next,

$$\langle s_N(f), g \rangle = \frac{1}{2\pi} \int_{-\pi}^{\pi} s_N(f; x) \overline{g(x)} dx = \sum_{k=-N}^N c_k \frac{1}{2\pi} \int_{-\pi}^{\pi} e^{ikx} \overline{g(x)} dx = \sum_{k=-N}^N c_k \overline{d_k}.$$

We need the Schwarz (or Cauchy–Schwarz or Cauchy–Bunyakovsky–Schwarz) inequality, that is,

$$\left| \int_a^b f \overline{g} \right|^2 \leq \left(\int_a^b |f|^2 \right) \left(\int_a^b |g|^2 \right).$$

This is left as an exercise. The proof is not really different from the finite-dimensional version. So

$$\begin{aligned} \left| \int_{-\pi}^{\pi} f \overline{g} - \int_{-\pi}^{\pi} s_N(f) \overline{g} \right| &= \left| \int_{-\pi}^{\pi} (f - s_N(f)) \overline{g} \right| \\ &\leq \int_{-\pi}^{\pi} |f - s_N(f)| |g| \\ &\leq \left(\int_{-\pi}^{\pi} |f - s_N(f)|^2 \right)^{1/2} \left(\int_{-\pi}^{\pi} |g|^2 \right)^{1/2}. \end{aligned}$$

The right-hand side goes to 0 as N goes to infinity by the first claim of the theorem. That is, as N goes to infinity, $\langle s_N(f), g \rangle$ goes to $\langle f, g \rangle$, and the second claim is proved. The last claim in the theorem follows by using $g = f$. \square

11.8.7 Exercises

Exercise 11.8.1: Take the Fourier series

$$\sum_{n=1}^{\infty} \frac{1}{2^n} \sin(2^n x).$$

Show that the series converges uniformly and absolutely to a continuous function. Note: This is another example of a nowhere differentiable function (you do not have to prove that)*. See Figure 11.11.

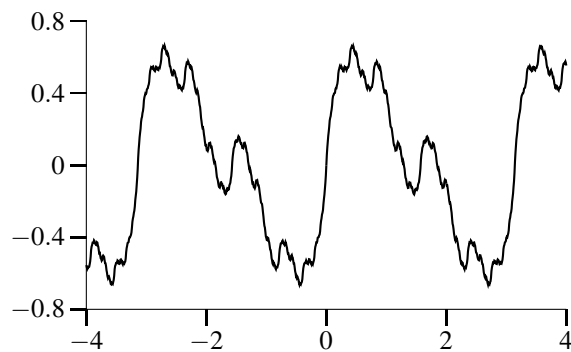

Figure 11.11: Plot of $\sum_{n=1}^{\infty} \frac{1}{2^n} \sin(2^n x)$.

Exercise 11.8.2: Suppose that a 2π -periodic function that is Riemann integrable on $[-\pi, \pi]$, and such that f is continuously differentiable on some open interval (a, b) . Prove that for every $x \in (a, b)$, we have $\lim s_N(f; x) = f(x)$.

Exercise 11.8.3: Prove Corollary 11.8.10, that is, suppose a 2π -periodic function is continuous piecewise smooth near a point x , then $\lim s_N(f; x) = f(x)$. Hint: See the previous exercise.

Exercise 11.8.4: Given a 2π -periodic function $f: \mathbb{R} \rightarrow \mathbb{C}$ Riemann integrable on $[-\pi, \pi]$, and $\varepsilon > 0$. Show that there exists a continuous 2π -periodic function $g: \mathbb{R} \rightarrow \mathbb{C}$ such that $\|f - g\|_2 < \varepsilon$.

Exercise 11.8.5: Prove the Cauchy–Bunyakovsky–Schwarz inequality for Riemann integrable functions:

$$\left| \int_a^b f \bar{g} \right|^2 \leq \left(\int_a^b |f|^2 \right) \left(\int_a^b |g|^2 \right).$$

Exercise 11.8.6: Prove the L^2 triangle inequality for Riemann integrable functions on $[-\pi, \pi]$:

$$\|f + g\|_2 \leq \|f\|_2 + \|g\|_2.$$

*See G. H. Hardy, *Weierstrass's Non-Differentiable Function*, Transactions of the American Mathematical Society, 17, No. 3 (Jul., 1916), pp. 301–325.

Exercise 11.8.7: Suppose for some C and $\alpha > 1$, we have a real sequence $\{a_n\}$ with $|a_n| \leq \frac{C}{n^\alpha}$ for all n . Let

$$g(x) := \sum_{n=1}^{\infty} a_n \sin(nx).$$

- a) Show that g is continuous.
 b) Formally (that is, suppose you can differentiate under the sum) find a solution (formal solution, that is, do not yet worry about convergence) to the differential equation

$$y'' + 2y = g(x)$$

of the form

$$y(x) = \sum_{n=1}^{\infty} b_n \sin(nx).$$

- c) Then show that this solution y is twice continuously differentiable, and in fact solves the equation.

Exercise 11.8.8: Let f be a 2π -periodic function such that $f(x) = x$ for $0 < x < 2\pi$. Use Parseval's theorem to find

$$\sum_{n=1}^{\infty} \frac{1}{n^2} = \frac{\pi^2}{6}.$$

Exercise 11.8.9: Suppose that $c_n = 0$ for all $n < 0$ and $\sum_{n=0}^{\infty} |c_n|$ converges. Let $\mathbb{D} := B(0, 1) \subset \mathbb{C}$ be the unit disc, and $\overline{\mathbb{D}} = C(0, 1)$ be the closed unit disc. Show that there exists a continuous function $f: \overline{\mathbb{D}} \rightarrow \mathbb{C}$ that is analytic on \mathbb{D} and such that on the boundary of \mathbb{D} we have $f(e^{i\theta}) = \sum_{n=0}^{\infty} c_n e^{in\theta}$.

Hint: If $z = re^{i\theta}$, then $z^n = r^n e^{in\theta}$.

Exercise 11.8.10: Show that

$$\sum_{n=1}^{\infty} e^{-1/n} \sin(nx)$$

converges to an infinitely differentiable function.

Exercise 11.8.11: Let f be a 2π -periodic function such that $f(x) = f(0) + \int_0^x g$ for a function g that is Riemann integrable on every interval. Suppose

$$f(x) \sim \sum_{n=-\infty}^{\infty} c_n e^{inx}.$$

Show that there exists a $C > 0$ such that $|c_n| \leq \frac{C}{|n|}$.

Exercise 11.8.12:

- a) Let φ be the 2π -periodic function defined by $\varphi(x) := 0$ if $x \in (-\pi, 0)$, and $\varphi(x) := 1$ if $x \in (0, \pi)$, letting $\varphi(0)$ and $\varphi(\pi)$ be arbitrary. Show that $\lim_{N \rightarrow \infty} s_N(\varphi; 0) = 1/2$.
 b) Let f be a 2π -periodic function Riemann integrable on $[-\pi, \pi]$, $x \in \mathbb{R}$, $\delta > 0$, and there are continuously differentiable $g: [x - \delta, x] \rightarrow \mathbb{C}$ and $h: [x, x + \delta] \rightarrow \mathbb{C}$ where $f(t) = g(t)$ for all $t \in [x - \delta, x]$ and where $f(t) = h(t)$ for all $t \in (x, x + \delta]$. Then $\lim_{N \rightarrow \infty} s_N(f; x) = \frac{g(x) + h(x)}{2}$, or in other words:

$$\lim_{N \rightarrow \infty} s_N(f; x) = \frac{1}{2} \left(\lim_{t \rightarrow x^-} f(t) + \lim_{t \rightarrow x^+} f(t) \right).$$

Further Reading

- [R1] Maxwell Rosenlicht, *Introduction to Analysis*, Dover Publications Inc., New York, 1986. Reprint of the 1968 edition.
- [R2] Walter Rudin, *Principles of Mathematical Analysis*, 3rd ed., McGraw-Hill Book Co., New York, 1976. International Series in Pure and Applied Mathematics.
- [T] William F. Trench, *Introduction to Real Analysis*, Pearson Education, 2003. http://ramanujan.math.trinity.edu/wtrench/texts/TRENCH_REAL_ANALYSIS.PDF.

Index

- algebra, 14, 166
- analytic, 138
- antiderivative, 80
- approximate delta function, 163
- arc-length measure, 72
- arc-length parametrization, 74
- Arzelà–Ascoli theorem, 158

- basis, 11
- Bessel’s inequality, 179
- bilinear, 19
- bounded domain with piecewise smooth boundary, 117

- Cantor function, 108
- Cantor set, 105
- Cauchy
 - complex series, 127
- Cauchy–Schwarz inequality, 19
- chain rule, 34
- change of basis, 24
- characteristic function, 113
- closed path, 66
- closed rectangle, 85
- column vectors, 7
- columns, 23
- commutative diagram, 27
- compact operator, 160
- compact support, 92
- complex algebra, 166
- complex conjugate, 126
- complex number, 125
- complex plane, 125
- conservative vector field, 82
- continuous piecewise smooth, 67, 182
- continuously differentiable, 44, 56
- continuously differentiable path, 66
- converges
 - complex series, 127
 - power series, 138
- converges absolutely
 - complex series, 127
- converges pointwise, 130
 - complex series, 130
- converges uniformly, 130
- convex, 15
- convex combination, 15
- convex hull, 17
- convolution, 163
- cosine, 148
- critical point, 41
- curve, 37

- Darboux integral, 87
- Darboux sum, 86
- derivative, 32
 - complex-valued function, 128
- determinant, 25
- Devil’s staircase, 108
- diagonal matrix, 29
- differentiable, 32
- differentiable curve, 37
- differential one-form, 68
- dimension, 11
- directional derivative, 38
- Dirichlet kernel, 180
- dot product, 19

- eigenvalue, 31
- elementary matrix, 28

- equicontinuous, 157
- euclidean norm, 19
- Euler's formula, 148
- even permutation, 25
- Fourier coefficients, 175
- Fourier series, 175
- Fubini for sums, 142
- Fubini's theorem, 97, 98
- fundamental theorem of algebra, 154
- generate an algebra, 170
- gradient, 37
- Green's theorem, 118
- hyperbolic cosine, 152
- hyperbolic sine, 152
- identity, 13
- identity theorem, 145
- imaginary axis, 125
- imaginary part, 126
- implicit function theorem, 51
- indicator function, 113
- inner product, 177
- integrable, 89
- integrable on S , 114
- inverse function theorem, 47
- invertible linear transformation, 13
- isolated singularity, 155
- Jacobian, 38
- Jacobian conjecture, 50
- Jacobian determinant, 38
- Jacobian matrix, 38
- Jordan measurable, 113
- k -times continuously differentiable function, 56
- Kronecker density theorem, 161
- Leibniz integral rule, 61
- length, 73
- length of a curve, 73
- linear, 13
- linear combination, 10
- linear operator, 13
- linear transformation, 13
- linearity of the integral, 89
- linearly dependent, 11
- linearly independent, 11
- longest side, 91
- lower Darboux integral, 87
- lower Darboux sum, 86
- map, 13
- mapping, 13
- matrix, 23
- maximum principle
 - analytic functions, 154
 - harmonic functions, 120
- mean value property, 120
- measure zero, 101
- modulus, 126
- monotonicity of the integral, 90
- n -dimensional volume
 - Jordan measurable set, 113
 - rectangles, 85
- negatively oriented, 117
- norm, 19
- normed vector space, 19
- null set, 101
- odd permutation, 25
- one-form, 68
- open mapping, 49
- open rectangle, 85
- operator norm, 20
- operator, linear, 13
- orthogonal system, 178
- orthonormal system, 178
- oscillation, 109
- outer measure, 101
- Parseval's theorem, 183
- partial derivative, 35
- partial derivative of order ℓ , 56
- partition, 85
- path connected, 77
- path independent, 77
- Peano existence theorem, 161
- Peano surface, 41

- permutation, 25
- piecewise continuously differentiable path, 66
- piecewise smooth, 182
- piecewise smooth boundary, 117
- piecewise smooth path, 66
- piecewise smooth reparametrization, 68
- Poincaré lemma, 80
- pointwise bounded, 156
- pointwise convergence, 130
 - complex series, 130
- polar coordinates, 54, 151
- pole, 155
- positively oriented, 117
- potential, 82
- preserve orientation, 68

- radius of convergence, 139
- rational function, 155
- real algebra, 166
- real axis, 125
- real part, 126
- real vector space, 8
- real-analytic, 138
- rectangle, 85
- refinement of a partition, 87
- relative maximum, 41
- relative minimum, 41
- relatively compact, 107, 160
- removable singularity, 155
- reparametrization, 68
- reverse orientation, 68
- Riemann integrable, 89
 - complex-valued function, 128
- Riemann integrable on S , 114
- Riemann integral, 89
- Riemann–Lebesgue theorem, 110

- scalars, 7
- self-adjoint, 170
- separates points, 167
- simple path, 66
- simply connected, 80
- sine, 148
- singularity, 155
- smooth path, 66
- smooth reparametrization, 68
- span, 10
- spectral radius, 31
- standard basis, 12
- star-shaped domain, 80
- Stone–Weierstrass
 - complex version, 170
 - real version, 167
- subrectangle, 85
- subspace, 8
- support, 92
- supremum norm, 131
- symmetric group, 25
- symmetric partial sums, 180

- Taylor’s theorem
 - real-analytic, 143
- total derivative, 77
- transformation, linear, 13
- triangle inequality
 - complex numbers, 126
 - norms, 19
- trigonometric polynomial, 174
- type I domain, 118
- type II domain, 118
- type III domain, 118

- uniform convergence, 130
- uniform norm, 131
- uniformly bounded, 156
- uniformly Cauchy, 131
- uniformly equicontinuous, 157
- upper Darboux integral, 87
- upper Darboux sum, 86
- upper triangular matrix, 28

- vanishes at no point, 167
- vector, 7
- vector field, 81
- vector space, 8
- vector subspace, 8
- volume, 113
- volume of rectangles, 85

- Weierstrass M -test, 131
- Weierstrass approximation theorem, 162

Weierstrass function, [135](#)
winding number, [83](#)

zero of a function, [155](#)

List of Notation

Notation	Description	Page
(v_1, v_2, \dots, v_n)	vector	7
$\begin{bmatrix} v_1 \\ \vdots \\ v_n \end{bmatrix}$	vector (column vector)	7
$\mathbb{R}[t]$	the set of polynomials in t	9
$\text{span}(Y)$	span of the set Y	10
e_j	standard basis vector $(0, \dots, 0, 1, 0, \dots, 0)$	12
$L(X, Y)$	set of linear maps from X to Y	13
$L(X)$	set of linear operators on X	13
$x \mapsto y$	function that takes x to y	15
$\ \cdot\ $	norm on a vector space	19
$x \cdot y$	dot product of x and y	19
$\ \cdot\ _{\mathbb{R}^n}$	the euclidean norm on \mathbb{R}^n	19
$\ \cdot\ _{L(X, Y)}$	operator norm on $L(X, Y)$	20
$GL(X)$	invertible linear operators on X	22
$\begin{bmatrix} a_{1,1} & \cdots & a_{1,n} \\ \vdots & \ddots & \vdots \\ a_{m,1} & \cdots & a_{m,n} \end{bmatrix}$	matrix	23
$\text{sgn}(x)$	sign function	25
\prod	product	25
$\det(A)$	determinant of A	25
f', Df	derivative of f	32, 128
$\frac{\partial f}{\partial x_j}$	partial derivative of f with respect to x_j	35
∇f	gradient of f	37
$D_u f, \frac{\partial f}{\partial u}$	directional derivative of f	38

Notation	Description	Page
$J_f, \frac{\partial(f_1, f_2, \dots, f_n)}{\partial(x_1, x_2, \dots, x_n)}$	Jacobian determinant of f	38
$C^1, C^1(U)$	continuously differentiable function/mapping	44
$\frac{\partial^2 f}{\partial x_2 \partial x_1}$	derivative of f with respect to x_1 and then x_2	56
$f_{x_1 x_2}$	derivative of f with respect to x_1 and then x_2	56
C^k	k -times continuously differentiable function	56
$\omega_1 dx_1 + \omega_2 dx_2 + \dots + \omega_n dx_n$	differential one-form	68
$\int_\gamma \omega$	path integral of a one-form	71
$\int_\gamma f ds, \int_\gamma f(x) ds(x)$	line integral of f against arc-length measure	72
$\int_\gamma v \cdot d\gamma$	path integral of a vector field	81
$V(R)$	n -dimensional volume	85, 113
$L(P, f)$	lower Darboux sum of f over partition P	86
$U(P, f)$	upper Darboux sum of f over partition P	86
$\int_R f$	lower Darboux integral over rectangle R	87
$\overline{\int_R f}$	upper Darboux integral over rectangle R	87
$\mathcal{R}(R)$	Riemann integrable functions on R	89, 114
$\int_R f, \int_R f(x) dx, \int_R f(x) dV$	Riemann integral of f on R	89, 114
$m^*(S)$	outer measure of S	101
$o(f, x, \delta), o(f, x)$	oscillation of a function at x	109
χ_S	indicator function of S	113
i	The imaginary number, $\sqrt{-1}$	125
$\operatorname{Re} z$	real part of z	126
$\operatorname{Im} z$	imaginary part of z	126
\bar{z}	complex conjugate of z	126
$ z $	modulus of z	126
$\ f\ _u$	uniform norm of f	131
e^z	complex exponential function	147
$\sin(z)$	sine function	148
$\cos(z)$	cosine function	148

Notation	Description	Page
π	the number π	149
$f(x) \sim \sum_{n=-\infty}^{\infty} c_n e^{inx}$	Fourier series for f	176
$\langle f, g \rangle$	inner product of functions	177
$\ f\ _2$	L^2 norm of f	177
$s_N(f; x)$	symmetric partial sum of a Fourier series	180